

# User's Guide

## Home Cinema **EH-TW6600W** **EH-TW6600**



## Using Each Guide

The guides for this projector are organized as shown below.

### Safety Instructions/Support and Service Guide

Contains information on using the projector safely, as well as a support and service guide, troubleshooting check lists, and so on. Make sure you read this guide before using the projector.



### User's Guide (this guide)

Contains information on setting up and basic operations before using the projector, using the Configuration menu, and handling problems and performing routine maintenance.



### Quick Start Guide

Contains information on the procedures for setting up the projector. Read this first.

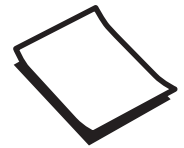

### 3D Glasses User's Guide

Contains information on handling the 3D Glasses and warnings and so on.

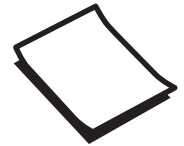

### WirelessHD Transmitter User's Guide (EH-TW6600W only)

Contains information on handling the WirelessHD Transmitter and warnings and so on.

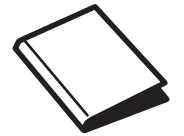

# Notations Used in This Guide

## Safety Indications

The documentation and the projector use graphical symbols to show how to use the projector safely. The following shows the symbols and their meanings. Please understand and respect these caution symbols in order to avoid injury to persons or property.

### Warning

This symbol indicates information that, if ignored, could possibly result in personal injury or even death due to incorrect handling.



### Caution

This symbol indicates information that, if ignored, could possibly result in personal injury or physical damage due to incorrect handling.

## General Information Indications

### Attention

Indicates procedures which may result in damage or malfunctions to occur.

	Indicates additional information and points which may be useful to know regarding a topic.
	Indicates a page where detailed information regarding a topic can be found.
Menu Name	Indicates Configuration menu items. Example: <b>Image - Color Mode</b>
Button Name	Indicates the buttons on the remote control or the control panel. Example:  button

## About the Use of "This Product" or "This Projector"

As well as the main projector unit, supplied items or optional extras may be referred to using the phrase "this product" or "this projector".

## Organization of the Guide and Notations in the Guide

<b>Using Each Guide</b> .....	<b>1</b>
<b>Notations Used in This Guide</b> .....	<b>2</b>
Safety Indications .....	2
General Information Indications .....	2
About the Use of "This Product" or "This Projector" .....	2

## Introduction

<b>Part Names and Functions</b> .....	<b>6</b>
Front/Top .....	6
Control Panel .....	7
Remote Control .....	8
Rear .....	10
Base .....	11

<b>Appearance</b> .....	<b>12</b>
-------------------------	-----------

## Preparing

<b>Installing</b> .....	<b>13</b>
Projected Image and Position of Projector .....	13
Installing in parallel with the screen .....	13
Installing the projector horizontally by adjusting the height of either side .....	13
Various Setting Methods .....	14
Placing on a table and projecting .....	14
Suspending from the ceiling and projecting .....	15
Projection Distance and Lens Shift Maximum Values .....	15
<b>Connecting a Device</b> .....	<b>18</b>
Connecting Video Equipment .....	18
Connecting a Computer .....	19
Connecting External Devices .....	19
Connecting to the Trigger Out port .....	19
Connecting to the Audio Out port .....	19
Connecting smartphones or tablets .....	20
Connecting USB devices .....	20
Connecting WirelessHD devices (EH- TW6600W only) .....	21
Attaching the Wireless LAN unit .....	22

Removing the Terminal Cover .....	22
-----------------------------------	----

## Preparing the Remote Control .....

Installing the Remote Control Batteries .....	23
Remote Control Operating Range .....	23
Operating range (left to right) .....	23
Operating range (top to bottom) .....	23

## Basic Operations

### Starting and Ending Projection .....

Turning on the Projector and Projecting .....	24
If the Target Image is not Projected .....	25
Turning Off .....	25

### Adjusting the Projected Screen .....

Displaying the Test Pattern .....	27
Adjusting the Focus .....	27
Adjusting the Projection Size (Zoom Adjustment) .....	27
Adjusting the Projector's Tilt .....	28
Adjusting the Position of the Projected Image (Lens Shift) .....	28
Making adjustments using the lens shift dial .....	28
Correcting Keystone Distortion (H/V-Keystone) .....	30
Adjusting the Volume .....	31
Hiding the Image and Muting the Audio Temporarily .....	31

## Adjusting the Image

### Adjusting the Image .....

Selecting the Projection Quality (Color Mode) .....	32
Switching the Screen Between Full and Zoom (Aspect) .....	33

### Absolute Color Adjustments .....

Adjusting Hue, Saturation, and Brightness .....	35
Adjusting the Gamma .....	35
Select and adjust the correction value .....	36
Adjust using the gamma adjustment graph .....	36
Adjusting the RGB (Offset/Gain) .....	36
Color Temp. ....	37

Skin Tone . . . . .	37
<b>Detailed Image Adjustments . . . . .</b>	<b>38</b>
Adjusting the Sharpness . . . . .	38
Setting Auto Iris . . . . .	39
Super-resolution and Detail Enhancement Functions . . . . .	39
Panel Alignment . . . . .	40
Image Processing . . . . .	41
<b>Viewing the Image at the Saved Image Quality (Memory Function) . . . . .</b>	<b>43</b>
Saving Function . . . . .	43
Saving a Memory . . . . .	43
Loading a Memory . . . . .	44
Deleting a Saved Memory . . . . .	44
Renaming a Memory . . . . .	44
 <b>Useful Functions</b>	
<b>Enjoying 3D Images . . . . .</b>	<b>46</b>
Setting 3D Images . . . . .	46
When the projector detects a 3D format . . . . .	46
When the projector cannot detect a 3D format . . . . .	46
If the 3D image cannot be viewed . . . . .	46
Using 3D Glasses . . . . .	47
Charging the 3D Glasses . . . . .	47
Pairing 3D Glasses . . . . .	47
Wearing the 3D Glasses . . . . .	48
Reading the indicator on the 3D Glasses . . . . .	49
Range for Viewing 3D Images . . . . .	49
Warnings Regarding Viewing 3D Images . . . . .	50
Converting 2D Images to 3D and Viewing . . . . .	52
 <b>Connecting with WirelessHD (EH- TW6600W Only) . . . . .</b>	<b>54</b>
Installing the WirelessHD Transmitter . . . . .	54
WirelessHD Transmitter part names . . . . .	54
WirelessHD Transmitter connection example and signal flow . . . . .	56
Setting the WirelessHD Transmitter . . . . .	58
Projecting Images . . . . .	59
WirelessHD Settings Menu . . . . .	60
WirelessHD Transmission Range . . . . .	61

Operating the Remote Control . . . . .	62
Remote Control Operating Range . . . . .	63
Switching the Input and Output . . . . .	63
Switching the target image . . . . .	63
Switching the image source . . . . .	65
Displaying as a Sub-Screen . . . . .	67
<b>Using the HDMI Link Function . . . . .</b>	<b>68</b>
HDMI Link Function . . . . .	68
HDMI Link Settings . . . . .	68
Device Connections . . . . .	69
 <b>Playing Back Image Data (Slideshow)</b>	
<b>.....</b>	<b>70</b>
Compatible Data . . . . .	70
Playing a Slideshow . . . . .	70
Display Settings for Image Files and Slideshow Operation Settings . . . . .	71
 <b>Projecting Two Different Images Using Picture in Picture . . . . .</b>	<b>72</b>
Types of Screen that can be Displayed Simultaneously . . . . .	72
Projecting on a Picture in Picture . . . . .	72
Starting and exiting Picture in Picture . . . . .	72
Changing the Picture in Picture settings . . . . .	73
 <b>Configuration Menu</b>	
<b>Configuration Menu Functions . . . . .</b>	<b>74</b>
Configuration Menu Operations . . . . .	74
Configuration Menu Table . . . . .	75
Image menu . . . . .	75
Signal menu . . . . .	77
Settings menu . . . . .	79
Memory menu . . . . .	84
Network menu . . . . .	84
Info menu . . . . .	87
Reset menu . . . . .	87
Picture in Picture menu . . . . .	88
 <b>Troubleshooting</b>	
<b>Problem Solving . . . . .</b>	<b>89</b>
Reading the Indicators . . . . .	89
Indicator status during an error/warning . . . . .	89

Indicator status during normal operation . . . . . 91

When the Indicators Provide No Help . . . . . 92

    Check the problem . . . . . 92

    Problems relating to images . . . . . 93

    Problems when projection starts . . . . . 96

    Problems with the remote control . . . . . 96

    Problems with the control panel . . . . . 97

    Problems with 3D . . . . . 97

    Problems with HDMI . . . . . 98

    Problems with WirelessHD (EH-TW6600W only) . . . . . 98

    Problems with USB storage devices . . . . . 100

    Other problems . . . . . 100

Event ID . . . . . 101

## **Maintenance**

---

**Maintenance . . . . . 102**

    Cleaning the Parts . . . . . 102

        Cleaning the air filter . . . . . 102

        Cleaning the main unit . . . . . 103

        Cleaning the lens . . . . . 104

        Cleaning the 3D Glasses . . . . . 104

    Replacement Periods for Consumables . . . . . 104

        Air filter replacement period . . . . . 104

        Lamp replacement period . . . . . 104

    Replacing Consumables . . . . . 105

        Replacing the air filter . . . . . 105

        Replacing the lamp . . . . . 106

        Resetting lamp hours . . . . . 108

## **Appendix**

---

**Optional Accessories and Consumables . . . . . 109**

    Optional Items . . . . . 109

    Consumables . . . . . 109

**Supported Resolutions . . . . . 110**

    Component Video . . . . . 110

    Composite Video . . . . . 110

    Computer Signals (Analog RGB) . . . . . 110

    HDMI1/HDMI2 Input Signal . . . . . 110

MHL Input Signal . . . . . 111

3D Input Signal HDMI . . . . . 111

WirelessHD Input Signal . . . . . 111

3D Input Signal MHL (via a WirelessHD Transmitter\*) . . . . . 112

**Specifications . . . . . 113**

**Glossary . . . . . 117**

**General Notes . . . . . 119**

    General Notice . . . . . 119

## Part Names and Functions

### Front/Top

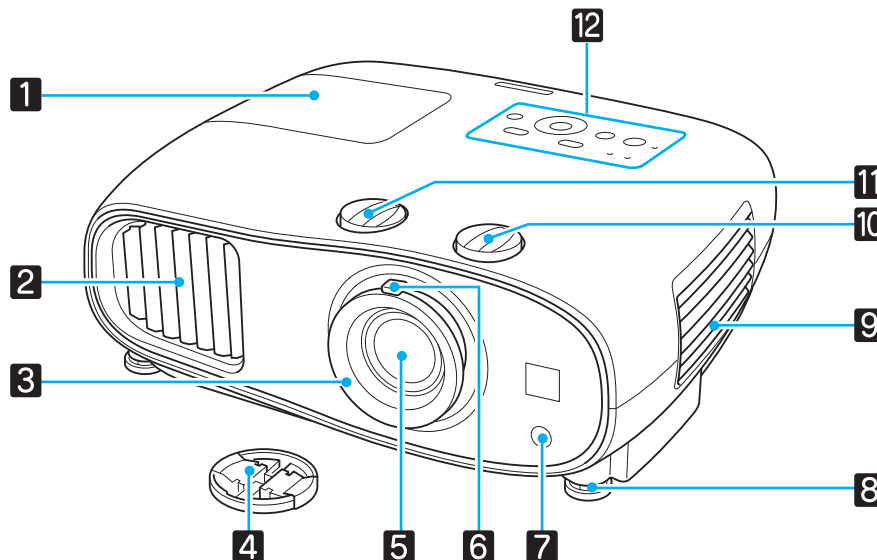

Name		Function
<b>1</b>	Lamp cover	Open when replacing the projector's lamp. <a href="#">p.106</a>
<b>2</b>	Air exhaust vent	Exhaust vent for air used to cool the projector internally.  <div style="border: 1px solid black; padding: 5px;"> <p><b>Caution</b></p> <p>While projecting, do not put your face or hands near the air exhaust vent, and do not place objects that may become warped or damaged by heat near the vent. Hot air from the air exhaust vent could cause burns, warping, or accidents to occur.</p> </div>
<b>3</b>	Focus ring	Adjusts the image focus. <a href="#">p.27</a>
<b>4</b>	Lens cap	Install when not using the projector to protect the lens from being scratched or soiled. <a href="#">p.24</a>
<b>5</b>	Projector's lens	Images are projected from here.
<b>6</b>	Zoom ring	Adjusts the image size. <a href="#">p.27</a>
<b>7</b>	Remote receiver	Receives signals from the remote control. <a href="#">p.23</a>
<b>8</b>	Front adjustable foot	When setup on a surface such as a table, extend the foot to adjust the horizontal tilt. <a href="#">p.28</a>
<b>9</b>	Air filter cover	When cleaning or replacing the air filter, open this cover and remove the air filter. <a href="#">p.102</a> , <a href="#">p.105</a>
	Air intake vent	Intake vent for air used to cool the projector internally.
<b>10</b>	Vertical lens shift dial	Turn the dial to move the position of the projected image up or down. <a href="#">p.28</a>
<b>11</b>	Horizontal lens shift dial	Turn the dial to move the position of the projected image left or right. <a href="#">p.28</a>

Name	Function
<b>12</b> Control panel	Control panel on the projector. 🖱️ <a href="#">p.7</a>

## Control Panel

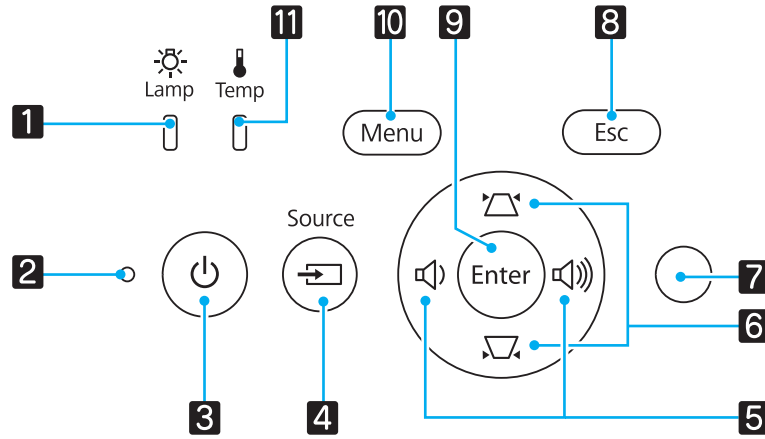







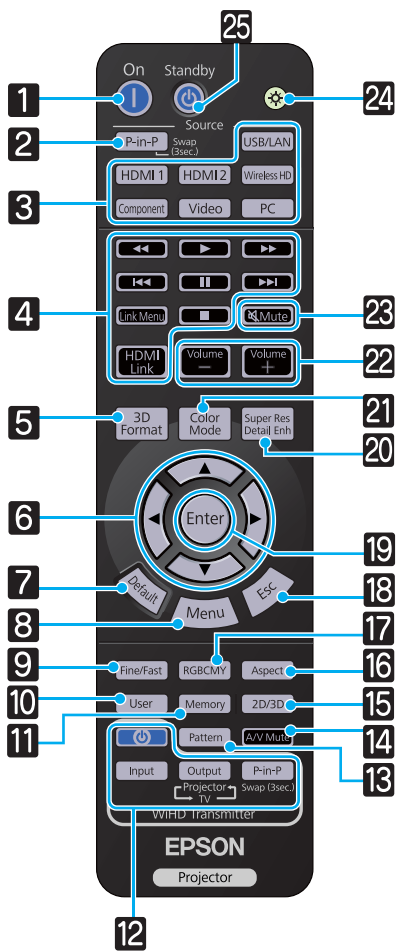



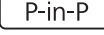



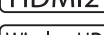
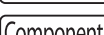







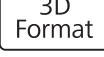



Buttons/Indicators	Function
<b>1</b> 	Flashes orange when it is time to replace the lamp. Shows the projector's errors through a combination of other indicators lit and flashing. 🖱️ <a href="#">p.89</a>
<b>2</b>  Operation indicator	Flashes to indicate warm-up in progress or cool-down in progress. Shows the projector's status through a combination of other indicators lit and flashing. 🖱️ <a href="#">p.89</a>
<b>3</b> 	Turns the projector power on or off. 🖱️ <a href="#">p.24</a> Lit when the projector is on. 🖱️ <a href="#">p.91</a>
<b>4</b>  Source	Changes to the image from each input port. 🖱️ <a href="#">p.25</a>
<b>5</b> 	Selects the adjustment value for the volume and for menu items. 🖱️ <a href="#">p.31</a> Performs horizontal keystone correction when the Keystone screen is displayed. 🖱️ <a href="#">p.30</a>
<b>6</b> 	Selects adjustment values for menu items. 🖱️ <a href="#">p.30</a> Performs vertical keystone correction when the Keystone screen is displayed. 🖱️ <a href="#">p.30</a>
<b>7</b>  Brightness sensor	Detects the brightness of the room. When Color Mode is set to "Auto", the optimum image quality is set according to the brightness detected by the sensor. 🖱️ <a href="#">p.32</a>
<b>8</b> 	Returns to the previous menu level when a menu is displayed. 🖱️ <a href="#">p.74</a>
<b>9</b> 	Selects functions and settings when a menu is displayed. 🖱️ <a href="#">p.74</a>
<b>10</b> 	Displays and closes the Configuration menu. On the Configuration menu, you can make adjustments and settings for Signal, Image, and so on. 🖱️ <a href="#">p.74</a>
<b>11</b> 	Flashes orange if the internal temperature is too high. Shows the projector's errors through a combination of other indicators lit and flashing. 🖱️ <a href="#">p.89</a>



Remote Control



Button	Function
<b>1</b> 	Turns the projector on.  <a href="#">p.24</a>
<b>2</b> 	Allows you to simultaneously project two image sources, one in the main screen and the other in the sub screen. (Picture in Picture)  <a href="#">p.72</a>  Press and hold the button to swap the main or sub screen image sources.
<b>3</b>       	Changes to the image from each input port.  <a href="#">p.25</a>   button is only available for EH-TW6600W.
<b>4</b> 	This button displays the settings menu for HDMI Link. With the other buttons, you can then start or stop playback, and so on for connected devices that meets the HDMI CEC standards or the MHL standards.  <a href="#">p.68</a>
<b>5</b> 	Changes the 3D format. This projector supports the following 3D formats. <ul style="list-style-type: none"> <li>• Frame Packing</li> <li>• Side by Side</li> <li>• Top and Bottom</li> </ul>  <a href="#">p.46</a>
<b>6</b>    	Selects menu items and adjustment values.  <a href="#">p.74</a>
<b>7</b> 	The adjustment value returns to its default value when pressed while the menu's adjustment screen is displayed.  <a href="#">p.74</a>
<b>8</b> 	Displays and closes the Configuration menu. On the Configuration menu, you can make adjustments and settings for Signal, Image, and so on.  <a href="#">p.74</a>
<b>9</b> 	Smoothly projects images with a quick frame rate, such as games.  <a href="#">p.41</a>

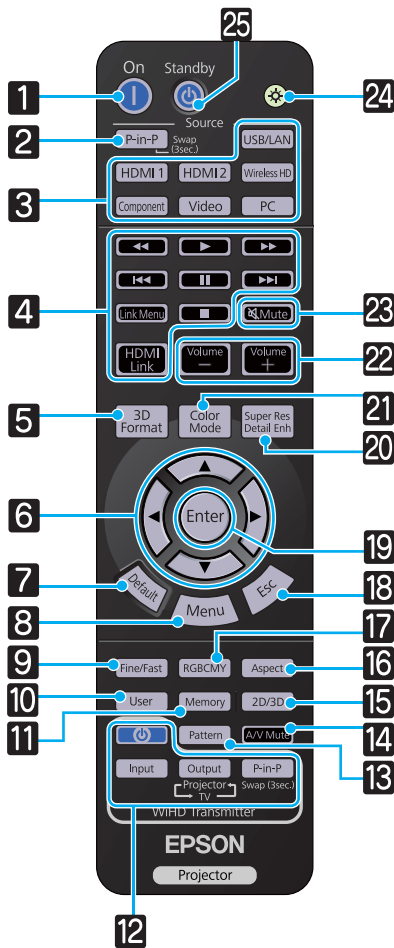

Button	Function
10	User Performs the function assigned to the user button. <a href="#">p.79</a>
11	Memory Saves, loads, or erases a memory. <a href="#">p.43</a>
12	(Only available for EH-TW6600W) Input Output P-in-P WiHD Transmitter control Turns on the WirelessHD Transmitter, or switches the input and output. Make sure you point the remote control at the WirelessHD Transmitter when performing operations. <a href="#">p.62</a>
13	Pattern Displays and closes the test pattern. <a href="#">p.27</a>
14	A/V Mute Temporarily hides or shows the image and audio. <a href="#">p.31</a>
15	2D/3D Changes between 2D and 3D. <a href="#">p.46</a>
16	Aspect Selects the aspect mode according to the input signal. <a href="#">p.33</a>
17	RGBCMY Adjusts the hue, saturation, and brightness for each RGBCMY color. <a href="#">p.35</a>
18	Esc Returns to the previous menu level when a menu is displayed. <a href="#">p.74</a>
19	Enter When a menu is displayed, it accepts and enters the current selection and moves to the next level. <a href="#">p.74</a>
20	Super Res Detail Enh Sets <b>Super-resolution</b> that makes fuzzy outlines clear, or <b>Detail Enhancement</b> that emphasizes the texture and material feel of images. <a href="#">p.39</a>
21	Color Mode Changes the <b>Color Mode</b> . <a href="#">p.32</a>
22	Volume - Volume + Adjusts the volume. <a href="#">p.31</a>
23	Mute Temporarily hides or shows the image and audio. <a href="#">p.31</a>
24	 The remote control buttons light up for approximately 10 seconds. This is useful when operating the remote control in the dark.
25	Standby  Turns the projector off. <a href="#">p.25</a>

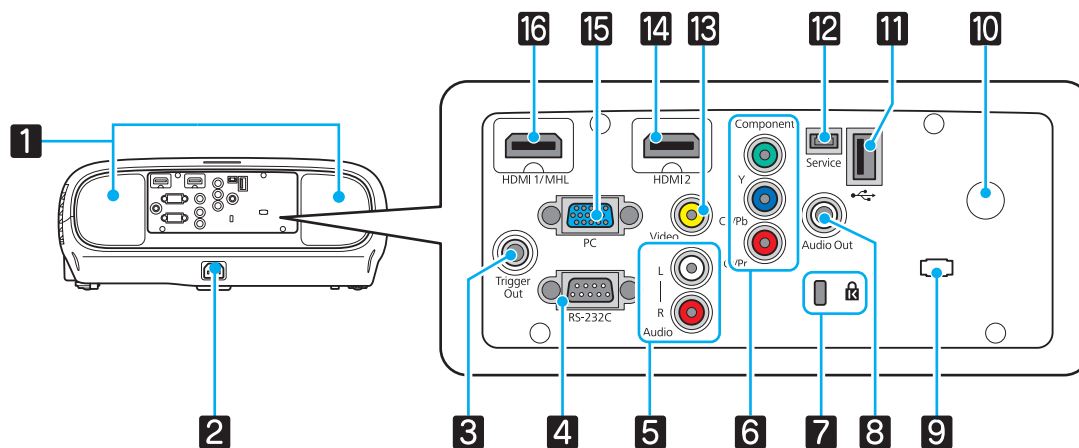

## Rear

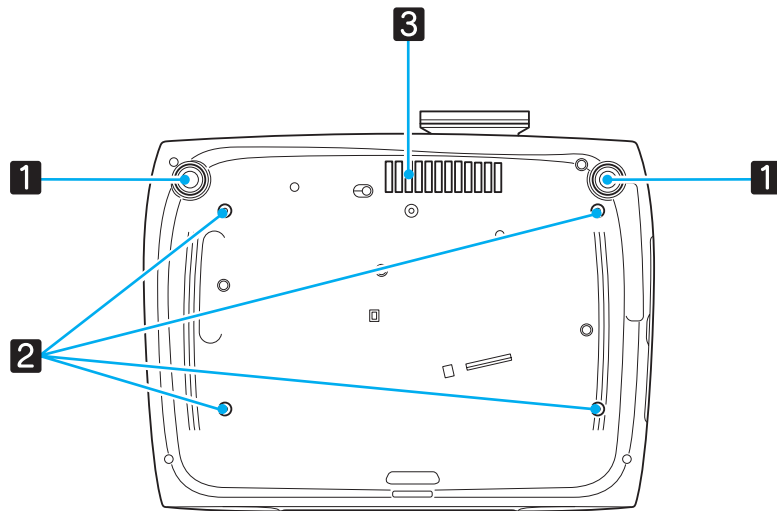

Name	Function
<b>1</b> Speaker	The projector's built-in speaker. Outputs audio. Set <b>Inverse Audio</b> to <b>On</b> to use the built-in speaker when the projector is suspended from a ceiling. ☛ <b>Settings - Audio - Inverse Audio</b> p.79
<b>2</b> Power inlet	Connect the power cord. ☛ p.24
<b>3</b> Trigger Out port	Connects with external devices such as motorized screens. ☛ p.19
<b>4</b> RS-232C port	When controlling the projector, connect the projector to a computer with an RS-232C cable. This port is for control use and should not normally be used. ☛ p.113
<b>5</b> Audio (L-R) port	Inputs audio from equipment connected to the Video port, the Component ports, or the PC port. ☛ p.18
<b>6</b> Component port	Connects to the component (YCbCr or YPbPr) output port on video equipment. ☛ p.18
<b>7</b> Security slot (🔒)	The security slot compatible with the MicroSaver security system manufactured by Kensington. For more details, visit the homepage of Kensington at <a href="http://www.kensington.com/">http://www.kensington.com/</a> .
<b>8</b> Audio Out port	Outputs audio during playback to external speakers. ☛ p.19
<b>9</b> Cable holder	When a cable is connected to a port, the weight of the cable may result in imperfect insertion of its connector. In order to prevent this, put a commercially available clamping band (cable tie) through this holder to bind and fix the cable.
<b>10</b> Remote receiver	Receives signals from the remote control. ☛ p.23
<b>11</b> USB port (TypeA)	Connects USB devices such as a USB memory device or a digital camera, and projects images as a slideshow. ☛ p.70 In addition, connects an optional wireless LAN unit. ☛ p.22
<b>12</b> Service port	Service port. This is not normally used.
<b>13</b> Video port	Connects to the composite video output port on video equipment. ☛ p.18
<b>14</b> HDMI2 port	Connects HDMI compatible video equipment and computers. ☛ p.18
<b>15</b> PC port	Connects to the RGB output port on a computer. ☛ p.19
<b>16</b> HDMI1 port	Connects HDMI compatible video equipment and computers. ☛ p.18 In addition, connects MHL compatible smart devices or tablets. ☛ p.19

## Base



Name		Function
<b>1</b>	Front adjustable foot	When setup on a surface such as a table, extend the foot to adjust the horizontal tilt.  <a href="#">p.28</a>
<b>2</b>	Ceiling mount fixing points (four points)	Attaches the optional ceiling mount here when suspending the projector from a ceiling.  <a href="#">p.109</a>
<b>3</b>	Air intake vent	When suspending from a ceiling, make sure it is setup so that dust does not collect in this section.



# Appearance

Units: mm

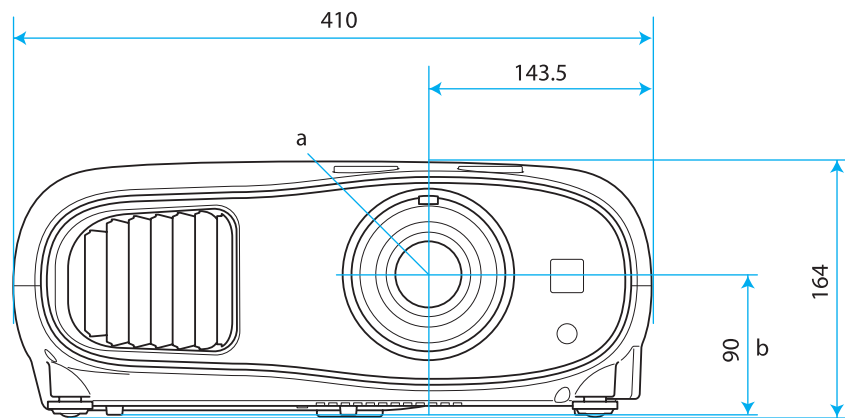

- a Center of lens
- b Distance from center of lens to suspension bracket fixing point

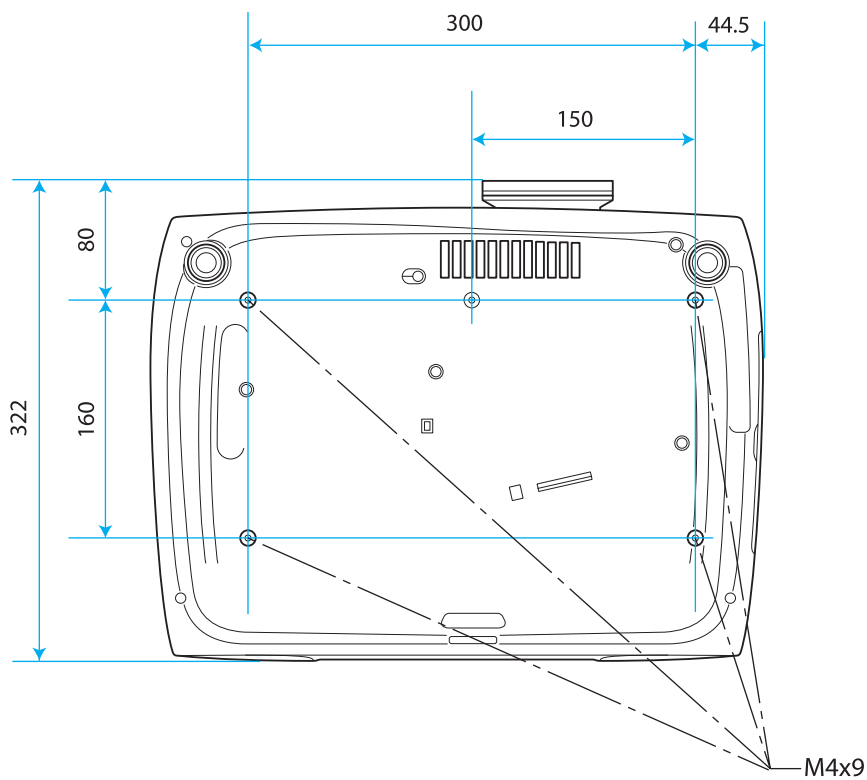



# Installing

## Projected Image and Position of Projector

Install the projector as follows.

### ■ Installing in parallel with the screen

If the projector is installed at an angle to the screen, keystone distortion occurs in the projected image. Adjust the projector's position so that it is installed in parallel with the screen.

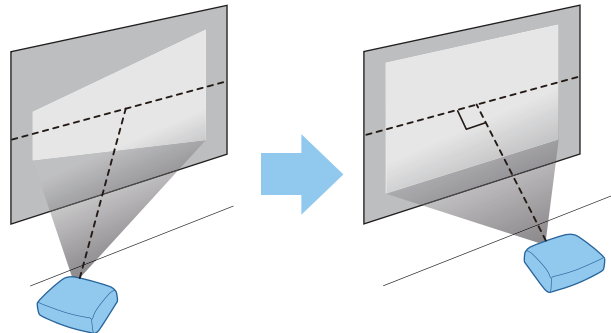

- If the projector cannot be installed in front of the screen, you can adjust the position of the image by using lens shift. 🖱️ [p.28](#)
- Use keystone correction when you cannot make adjustments using lens shift. 🖱️ [p.30](#)

### ■ Installing the projector horizontally by adjusting the height of either side

If the projector is tilted, the projected image is also tilted.

Install the projector horizontally so that both sides are at the same height.

If the projector cannot be installed horizontally, you can adjust the projector's tilt with the front foot. 🖱️ [p.28](#)

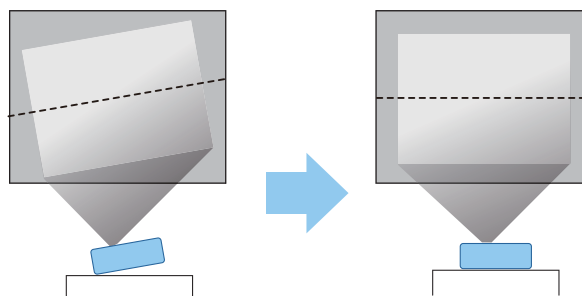

## Various Setting Methods



### Warning

- A special method of installation is required when suspending the projector from a ceiling (ceiling mount). If it is not installed correctly, it could fall causing an accident and injury.
- If you use adhesives, lubricants, or oil on the ceiling mount fixing points to prevent screws from loosening, or if you use things such as lubricants or oils on the projector, the projector case may crack causing it to fall from its ceiling mount. This could cause serious injury to anyone under the projector and also damage the projector.
- Do not install it on an unstable shelf or in a place out of load range. Otherwise, it could fall or topple causing an accident and injury.
- When installing it in a high position such as on a shelf, take measures against falling by using wires to ensure the safety in an emergency, such as an earthquake, and prevent accidents. If it is not installed correctly, it could fall causing an accident and injury.
- Do not block the air intake vent and air exhaust vent of the projector. Blocking its air intake vent and air exhaust vent may trap heat inside causing fire.

### Attention

- Try not to setup the projector in locations subject to high humidity and dust, or in locations subject to smoke from fires or tobacco smoke.
- Do not use the projector installed vertically. Doing so could cause a malfunction.
- Clean the air filter once every three months. Clean it more often if the environment is particularly dusty.  [p.102](#)



- If the projector cannot be installed in front of the screen, you can adjust the position of the image by using lens shift.  [p.28](#)
- Use keystone correction when you cannot make adjustments using lens shift.  [p.30](#)

### Placing on a table and projecting

You can install the projector on a table in your living room or on a low shelf to project images.

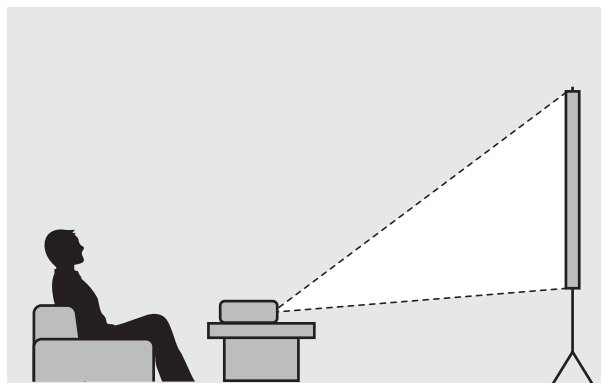

## ■ Suspending from the ceiling and projecting

You can suspend the projector from the ceiling with the optional ceiling mount to project images.

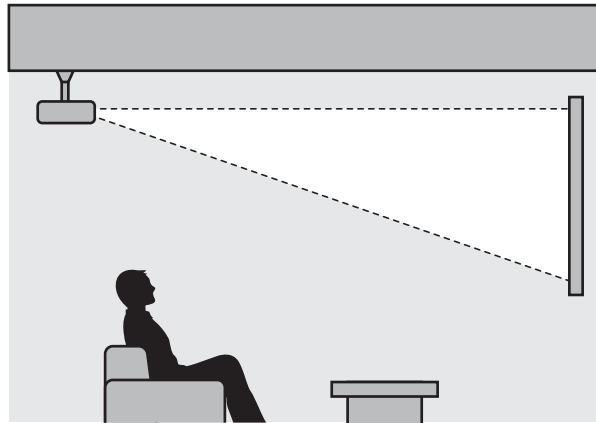

- When projecting from a ceiling, change **Projection** to a ceiling setting. [Settings - Projection p.79](#)
- Set **Inverse Audio** to **On** to use the built-in speaker when the projector is suspended from a ceiling. [Settings - Audio - Inverse Audio p.79](#)

## Projection Distance and Lens Shift Maximum Values

The size of the projection increases as the projector is moved away from the screen. Use the table below to setup the projector at the optimum position from the screen. The values given here are for your reference only. The maximum lens shift adjustment values are shown in the following table.

When adjusting the projection position vertically in lens shift

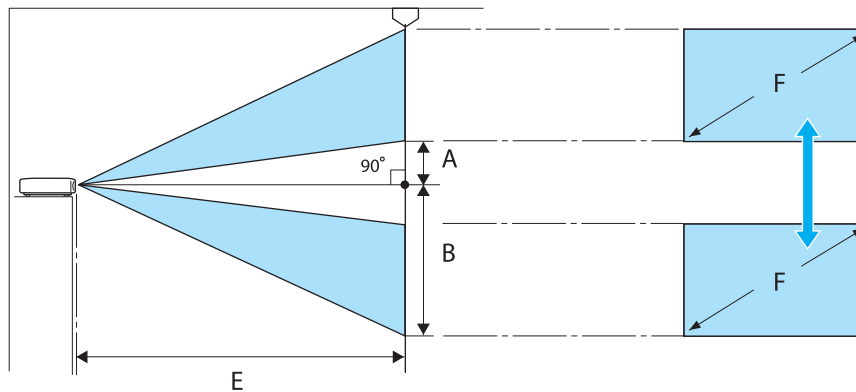

- A : Distance from the center of the lens to the bottom edge of the projected image (when lens shift is raised to its highest level)
- B : Distance from the center of the lens to the bottom edge of the projected image (when lens shift is lowered to its lowest level)
- E : Projection distance from the projector to the screen
- F : Size of the projected image



When adjusting the projection position horizontally in lens shift

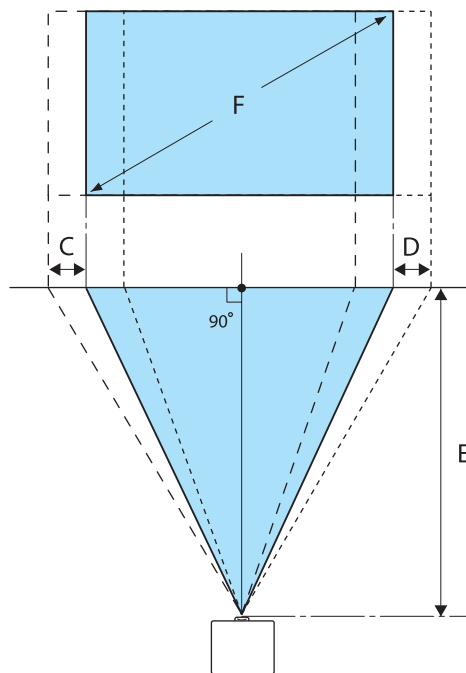

- C : Lens center movement distance when the projector is moved (when lens shift is set to maximum left)
- D : Lens center movement distance when the projector is moved (when lens shift is set to maximum right)
- E : Projection distance from the projector to the screen
- F : Size of the projected image

Unit: cm

16:9 Screen Size		Projection Distance (E)		Lens Shift Maximum Values*		
F	W x H	Minimum (Wide)	Maximum (Tele)	Distance (A)	Distance (B)	Distance (C, D)
40"	89 x 50	116	190	5	55	21
60"	130 x 75	176	286	7	82	32
80"	180 x 100	235	382	10	110	43
100"	220 x 120	295	478	12	137	53
120"	270 x 150	354	575	15	164	64
150"	330 x 190	443	719	19	205	80
180"	440 x 250	532	863	22	247	96

4:3 Screen Size		Projection Distance (E)		Lens Shift Maximum Values*		
F	W x H	Minimum (Wide)	Maximum (Tele)	Distance (A)	Distance (B)	Distance (C, D)
40"	81 x 61	143	233	6	67	26
60"	120 x 90	216	351	9	101	39
80"	160 x 120	288	468	12	134	52
100"	200 x 150	361	586	15	168	65
120"	240 x 180	434	704	18	201	78
150"	300 x 230	443	719	23	251	98
200"	410 x 300	591	1175	30	335	130

\* Vertical and horizontal lens shift cannot both be set to their maximum values. [p.28](#)

Installation example (with 16:9 screen size and 100")

Side view

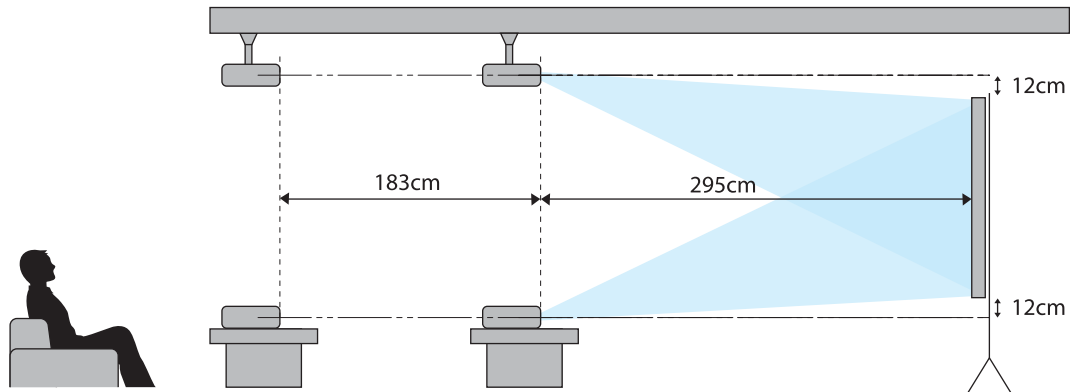

Overhead view

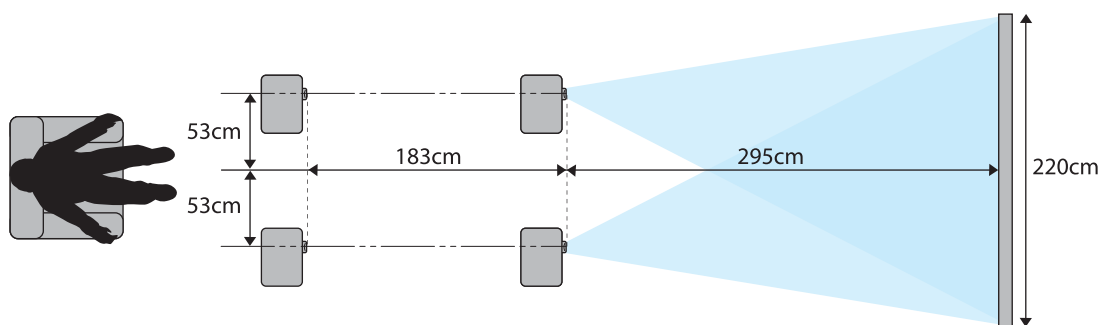

# Connecting a Device

## Attention

- Make cable connections before connecting to a power outlet.
- When disconnecting, turn off the projector first, then remove the power cord, and then disconnect other cables.
- Check the shape of the cable's connector and the shape of the port, and then connect. If you force a connector of a different shape into the port, it could cause damage and a malfunction to occur.

EH-TW6600W comes with a terminal cover allowing you to clearly see the connector section on the rear. Remove the terminal cover before connecting any cables.  [p.22](#)

## Connecting Video Equipment

To project images from DVD players or VHS video and so on, connect to the projector using one of the following methods.

### When using an HDMI cable

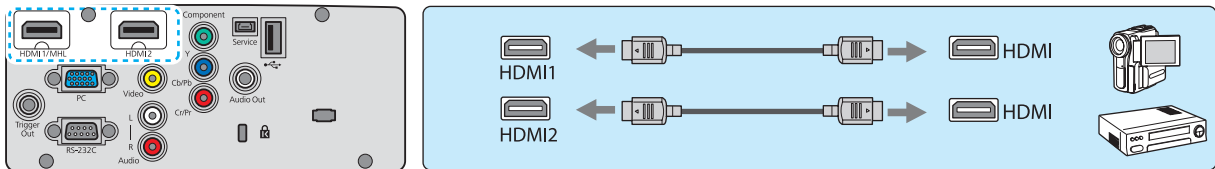

### When using a video cable

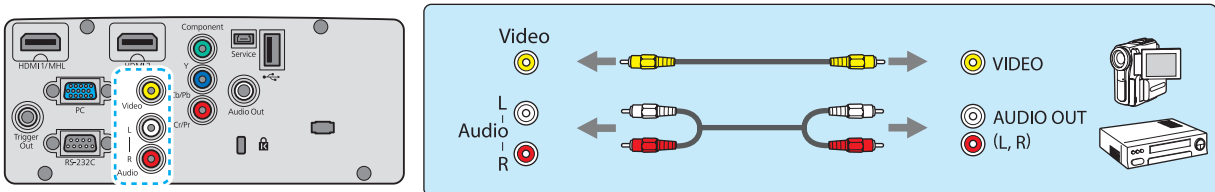

### When using a component video cable

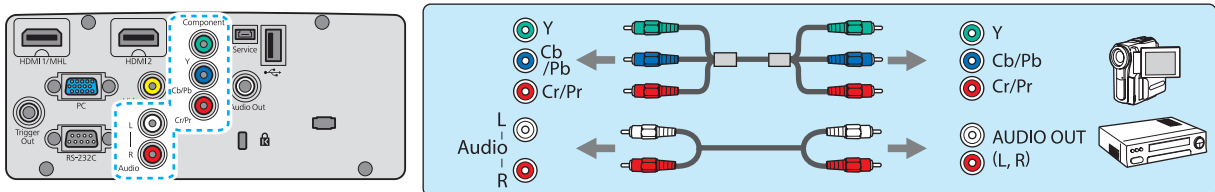

-  • The cable differs depending on the output signal from the connected video equipment.
- Some types of video equipment are capable of outputting different types of signals. Check the user's guide supplied with the video equipment to confirm which signals can be output.
- You can also connect your AV system to enjoy the audio from connected equipment.

## Connecting a Computer

To project images from a computer, connect the computer using one of the following methods.

### When using a computer cable

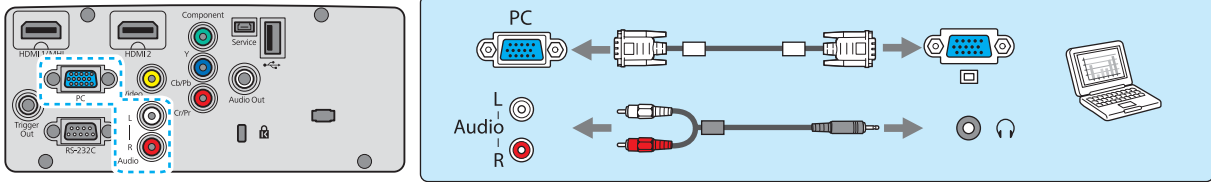

### When using an HDMI cable

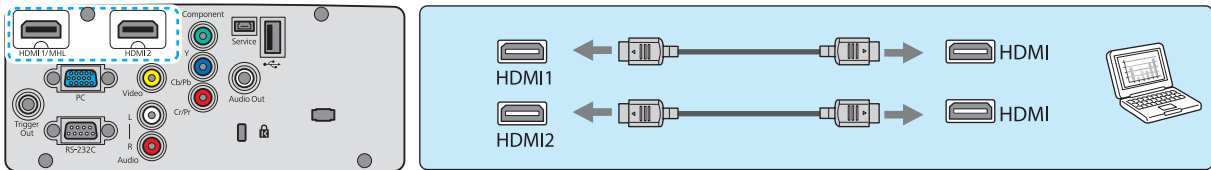

## Connecting External Devices

### Connecting to the Trigger Out port

To connect external devices such as motorized screens, connect a mini-jack stereo cable (3.5 mm) to the Trigger Out port.

When set to on, a signal (12 V DC) is output from this port to communicate the projector's status (on or off) to connected devices such as electric screens.

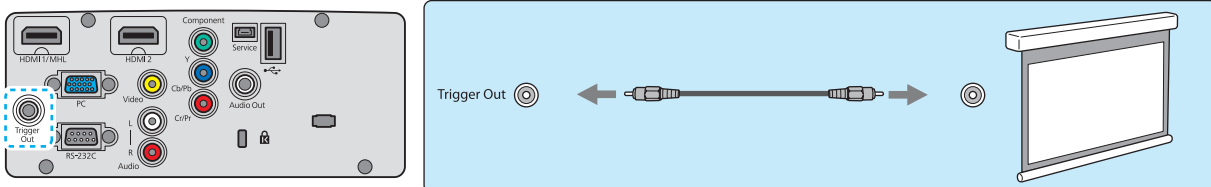

When using the Trigger Out port, set the Trigger Out function. **Settings - Operation - Trigger Out p.79**

### Connecting to the Audio Out port

To connect external devices such as external speakers, connect a commercially available audio cable.

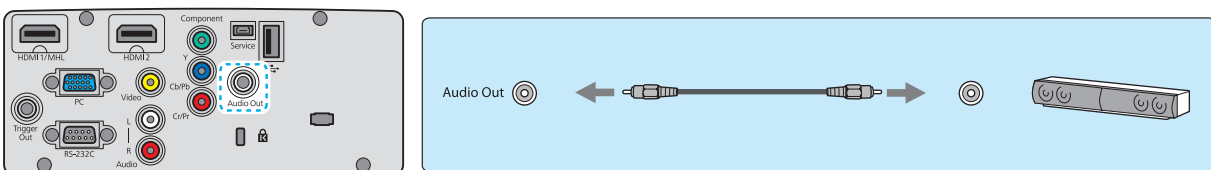

- Do not connect headphones.
- When the projector is in standby status, no audio can be output.

## Connecting smartphones or tablets

You can connect MHL compatible smartphones or tablets.

Use an MHL compatible cable to connect the micro USB port of smartphones and tablets to the HDMI1 port on the projector.

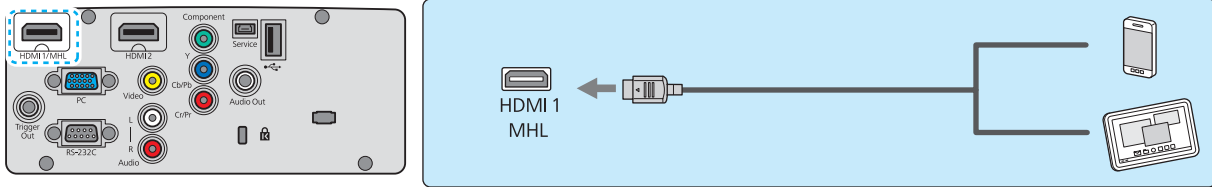

You can also view video and listen to music while charging a smartphone or tablet.

### Attention

- Make sure the connection cable supports the MHL standards. During charging, the smartphone or tablet could generate heat, cause a liquid leak, explode or generate other conditions that could result in a fire.
- When a connection is made using an MHL-HDMI conversion adapter, it may not be possible to charge or control the device from the remote control.



- Some devices use more power during video playback than what is supplied and will therefore not enable charging during video playback or other operations.
- When the projector is in standby status or when a smartphone or tablet has no remaining battery level, it cannot be charged.

## Connecting USB devices

You can connect USB devices such as USB memories, and USB compatible digital cameras.

Using the USB cable supplied with the USB device, connect the USB device to the USB port (TypeA) on the projector.

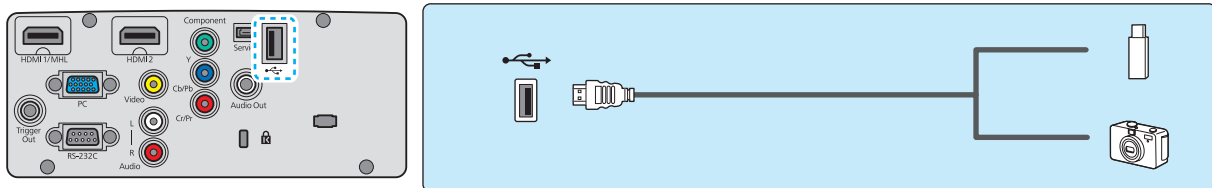

When the USB device is connected, you can project image files on the USB memory or digital camera as a slideshow. [p.70](#)

When you have finished projecting, remove USB devices from the projector. For devices with a power switch, make sure you turn them off before disconnecting the USB device.

### Attention

- If you use a USB hub, the connection may not operate correctly. Devices such as digital cameras and USB devices should be connected to the projector directly.
- Connect a digital camera using a USB cable specified for use with the device. Since the USB cable supplied with the 3D Glasses is exclusively for the 3D Glasses, it cannot be used for connecting a digital camera or a USB device.
- Use a USB cable less than 3 m in length. If the cable exceeds 3 m, slideshow may not function correctly.

## Connecting WirelessHD devices (EH-TW6600W only)

The projector receives transmissions from the WirelessHD Transmitter, and projects the images. [p.54](#)

Change the projected image by pressing the button on the remote control or the button on the control panel.



- When receiving WirelessHD images, make sure **WirelessHD** is set to **On**. **Settings - WirelessHD** [p.79](#)
- You can change which device is displayed by selecting a device from **Device Connections** in **HDMI Link**. **HDMI Link-Device Connections** [p.69](#)

## Connecting smartphones or tablets (EH-TW6600W only)

You can connect MHL compatible smartphones or tablets to the WirelessHD Transmitter.

Use an MHL compatible cable to connect the micro USB port of smartphones and tablets to the HDMI5 port on the WirelessHD Transmitter.

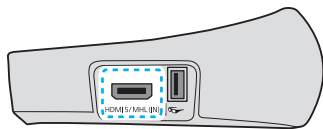

You can operate smartphones or tablets from the projector remote control.

You can also view video and listen to music while charging a smartphone or tablet.

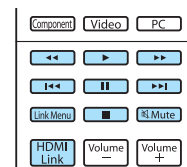

### Attention

- Make sure the connection cable supports the MHL standards. During charging, the smartphone or tablet could generate heat, cause a liquid leak, explode or generate other conditions that could result in a fire.
- When a connection is made using an MHL-HDMI conversion adapter, it may not be possible to charge or control the device from the remote control.



Some devices use more power during video playback than what is supplied and will therefore not enable charging during video playback or other operations.

## Attaching the Wireless LAN unit

To use the wireless LAN function, attach an optional Wireless LAN unit (ELPAP07).  
Insert the Wireless LAN unit to the USB port (TypeA).

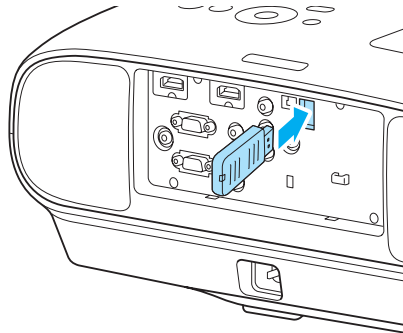

To project images via a wireless LAN, you need to download the following applications. For more details, see the download page.

- **Projecting computer screens by wireless**

Use EasyMP Network Projection to project computer screens via a network.

EasyMP Network Projection can be downloaded from the following Web site.

<http://www.epson.com>

- **Projecting images from a mobile terminal via a network**

When installing "Epson iProjection" in a smartphone or tablet, you can project data in the terminal by wireless. You can enjoy the images from a smartphone or tablet easily.

"Epson iProjection" can be downloaded free of charge from App Store or Google Play. A communication fee for the connection to App Store or Google Play will be charged to customers.



- When not using the wireless LAN function with the Wireless LAN unit kept inserted, set **Wireless LAN Power** to **Off**. This can prevent unauthorized access from outsiders. 🖱️ p.85
- When using Epson iProjection or EasyMP Network Projection in **Quick**, we recommend making security settings. 🖱️ p.86

## Removing the Terminal Cover

The terminal cover is attached to the connector section on the rear of EH-TW6600W. Remove this cover when using a cable to connect a device.

There are gaps at the bottom of the terminal cover that allows you to pull the cover forward and lift it from the grooves at the top.

When reattaching, first insert the protruding sections into the grooves at the top.

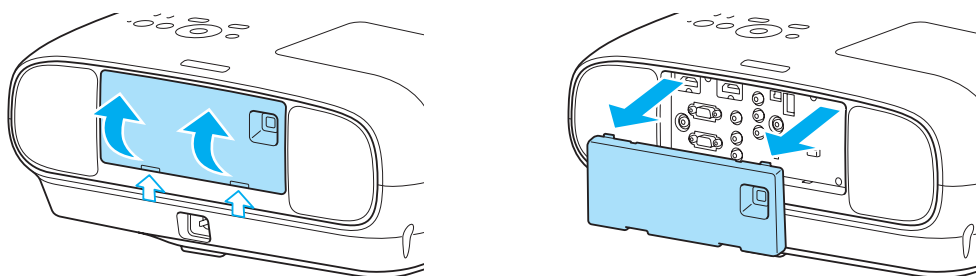

# Preparing the Remote Control

## Installing the Remote Control Batteries

### Attention

- Check the positions of the (+) and (-) marks inside the battery holder to ensure the batteries are inserted the correct way.
- You cannot use other batteries except for the AA size manganese or alkaline.

- 1** Remove the battery cover.  
While pushing the battery compartment cover catch, lift the cover up.

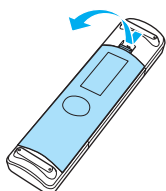

- 2** Replace the old batteries with new batteries.  
Check the polarity of the batteries (+) and (-) before installing.

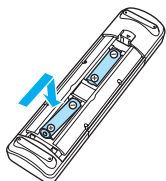

- 3** Reattach the battery cover.  
Press the cover until it clicks into place.

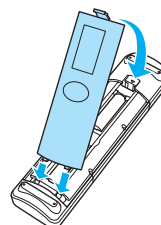

 If delays in the responsiveness of the remote control occur or if it does not operate, it probably means that the batteries are becoming flat. When this happens, replace them with new batteries. Have two AA size manganese or alkaline batteries ready.

## Remote Control Operating Range

The operation range for the WirelessHD Transmitter differs.  [p.63](#)

### Operating range (left to right)

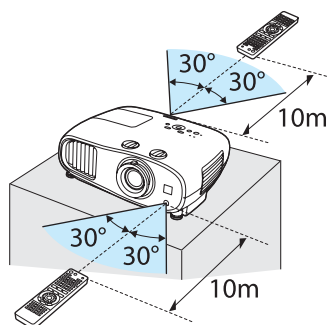

### Operating range (top to bottom)

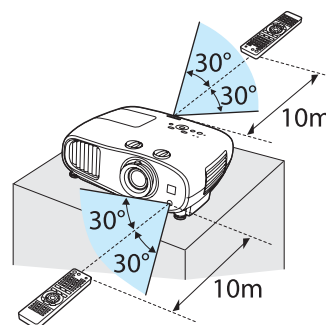



# Starting and Ending Projection

## Turning on the Projector and Projecting

- 1 Connect the equipment to the projector.
- 2 Connect the power cord.  
Connect using the power cord supplied.
- 3 Remove the lens cap.

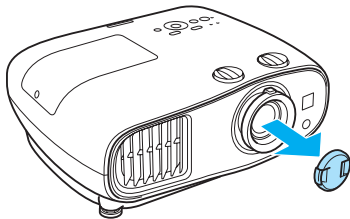

- 4 Turn on the connected equipment.

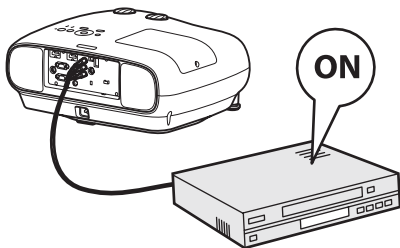

- 5 Turn on the projector.

Remote control

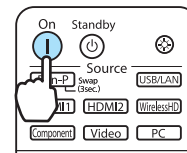

Control panel

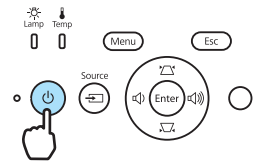

When **Direct Power On** is set to **On**, you can start projecting by simply connecting the power cord to the projector without having to press any buttons. **Settings - Operation - Direct Power On** p.79

### Warning

Do not look into the lens during projection.

### Caution

Do not disconnect the power cord from the main projector unit or the electrical outlet during projection.



- This projector provides a Child Lock function to prevent children from accidentally turning the power on and a Control Panel Lock function to prevent accidental operations and so on. **Settings - Lock Setting - Child Lock/Control Panel Lock** p.79
- When using at an altitude of 1500 m or more, set **High Altitude Mode** to **On**. **Settings - Operation - High Altitude Mode** p.79
- This projector provides an Auto Setup function to automatically select the optimum settings when the input signal for the connected computer image changes. **Signal - Auto Setup** p.77
- This projector comes with a Trigger Out port to communicate the current status of the projector's power (on/off) to external devices. When using this function, set Trigger Out. **Settings - Operation - Trigger Out** p.79
- Do not attach the lens cap during projection.
- If the projector is suspended from a ceiling, after removing the lens cap, make sure you keep it in a safe place as you will need to attach it when transporting the projector.

## If the Target Image is not Projected

If the image is not projected, you can change the source using one of the following methods.

### Remote control

Press the button for the target port.

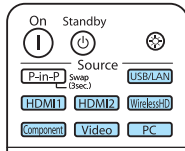

### Control panel

Press the button and select the target port.

Press the button to confirm the selection.

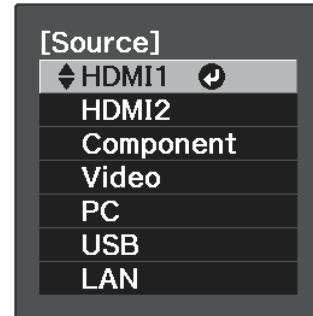

For video equipment, start playback first and then change the source.

## Turning Off

### 1 Turn off the connected equipment.



When **Power Off Link** is set to **On** in the **HDMI Link** menu, turning off HDMI CEC compatible equipment may also turn off the projector. **Settings - HDMI Link - Power Off Link** p.79

### 2 Press the button on the remote control or the projector's control panel.

#### Remote control

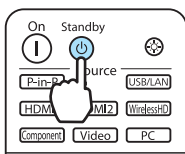

#### Control panel

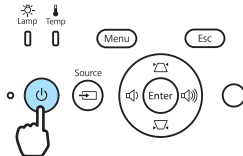

A confirmation message is displayed.

### 3 Press the button again.

Power Off?

Yes : Press button  
No : Press any other button



When **Standby Confirmation** is set to **Off**, you can turn off the projector by pressing the button on the remote control once. **Settings - Display - Standby Confirmation** p.79

### 4 Wait until cool-down is complete.

The operation indicator on the projector's control panel stops flashing.

### 5 Disconnect the power cord.



- If the power cord is connected, some electricity is consumed even if no operations are made.
- When connecting the power cord again, wait a sufficient time interval.

6

Attach the lens cap.

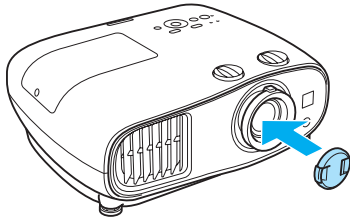



# Adjusting the Projected Screen

## Displaying the Test Pattern

When adjusting the zoom/focus or the projection position just after setting up the projector, you can display a test pattern instead of connecting video equipment.

Press the **Pattern** button on the remote control to display the test pattern.

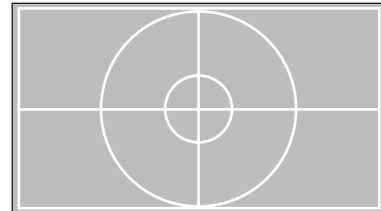
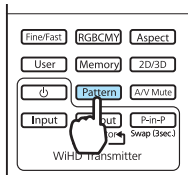

You can adjust the display position and so on by using this test pattern.

Press the **Esc** button to end this test pattern display.

## Adjusting the Focus

Turn the focus ring to adjust the focus.

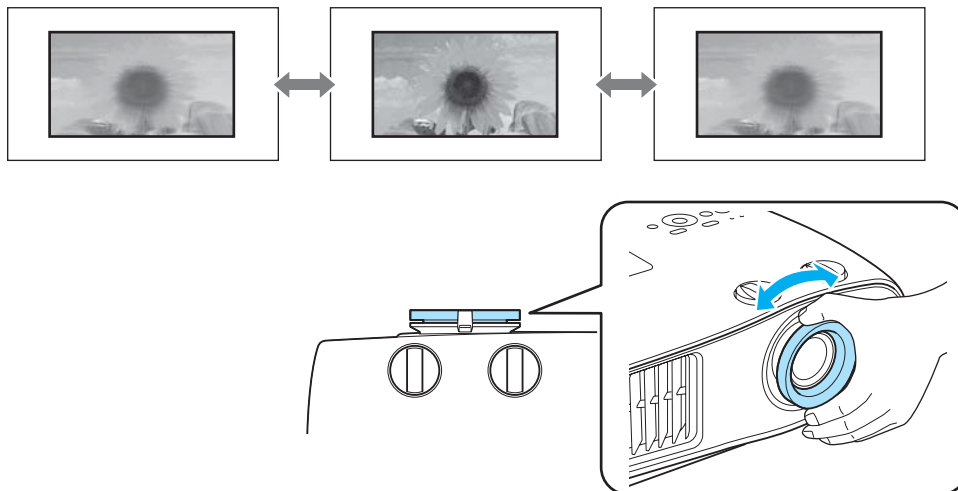

## Adjusting the Projection Size (Zoom Adjustment)

Grip the knob and turn the zoom ring to adjust the size of the projected screen.

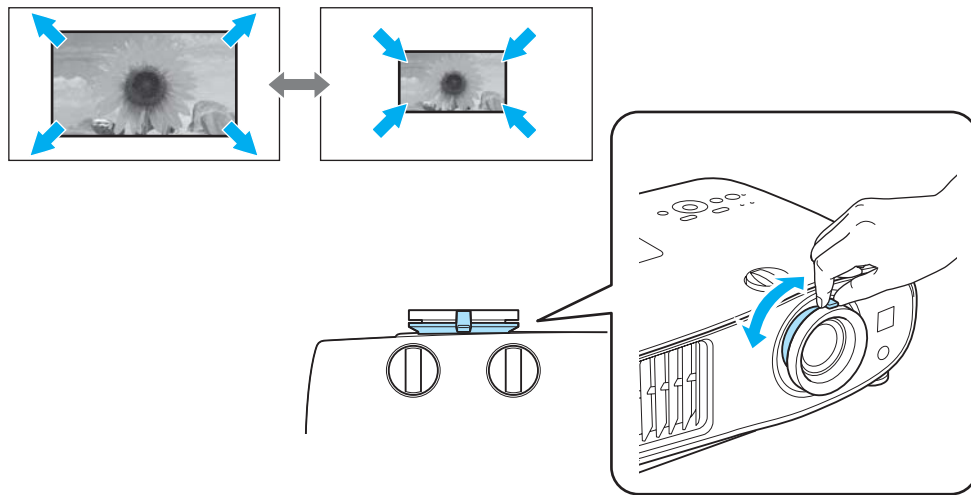

### Adjusting the Projector's Tilt

If the projection screen is tilted (the left and right sides of the projector are at different heights) when the projector is setup on a table, adjust the front foot so that both sides are level with each other.

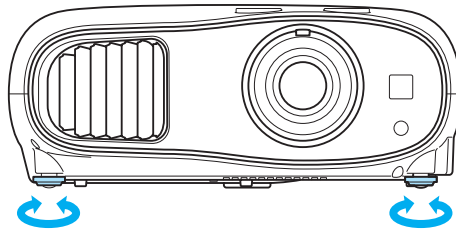

### Adjusting the Position of the Projected Image (Lens Shift)

If the projector cannot be installed directly in front of the screen, you can adjust the position of the image by using lens shift.

#### ■ Making adjustments using the lens shift dial

Turn the vertical and horizontal lens shift dials on the projector to adjust the position of the projected image. To locate the center of the lens shift range, turn the lens shift dial until you hear it clicks.

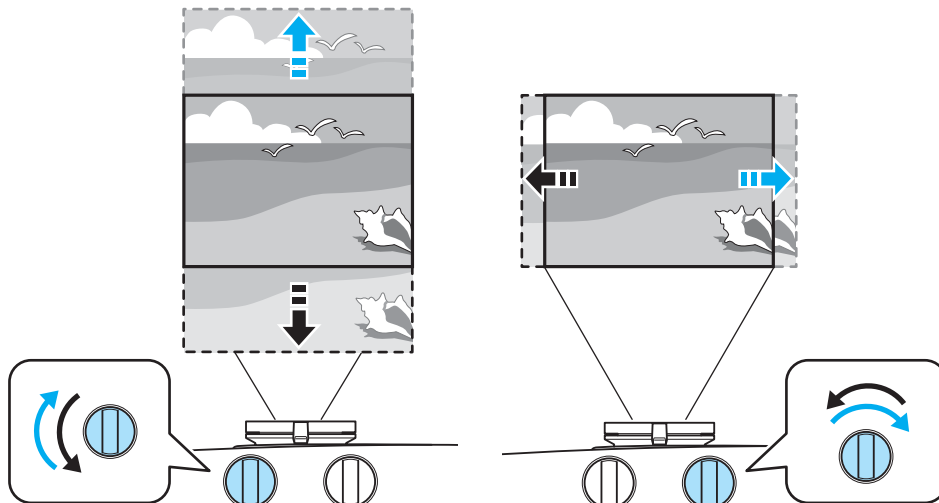

### Attention

- When using vertical lens shift for adjusting the position of the image, adjust the image by moving it upward and then finish the adjustment. If you move the image downward and finish the adjustment, its position may lower slightly.
- Do not keep turning the lens shift dials without effect. Once the projection image is positioned all the way to one edge, turning the dial further may impair image quality.



- Since images are unstable immediately after the projector is turned on, before you make focus, zoom, or lens shift settings, we recommend waiting 30 minutes or more after starting to project the images.
- The sharpest images will be achieved when both of the vertical and horizontal lens shift dials are centered.

You can move the image using lens shift within the following range.

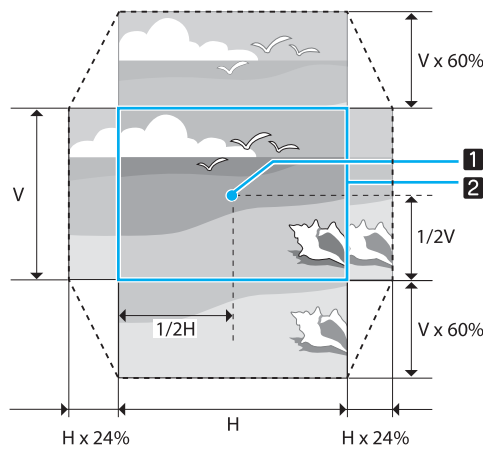

- 1 Center of the lens
- 2 Projected image with lens shift centered



### Caution

Before transporting the projector, make sure to adjust the lens position to the center using the lens shift dials. If you transport the projector when the lens is shifted up, down, left, or right, the lens shift mechanism could be damaged. Also, attach the protective pad that was attached when you purchased it.



- When adjusting the projection position using lens shift, you are recommended to install the projector in parallel with the screen.

## Correcting Keystone Distortion (H/V-Keystone)

You can use the buttons on the control panel to correct keystone distortion.

- You can maintain the quality of the projected image by adjusting the projection position using lens shift. Use keystone correction when you cannot make adjustments using lens shift.
- To use keystone correction, rotate the lens shift dials to adjust the lens as shown below.
  - Horizontal position of lens: Center
  - Vertical position of lens: Top edge
 If the lens is not positioned correctly, the projected image may be distorted.

Press the buttons to display the V-Keystone/H-Keystone gauges. When the gauges are displayed, press the buttons to perform vertical correction, and press the buttons to perform horizontal correction.

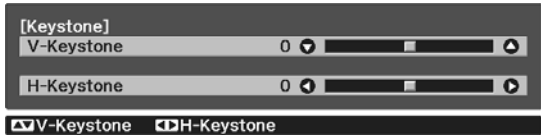

- You can adjust the volume by pressing the buttons when the V-Keystone/H-Keystone gauges are not displayed. [p.31](#)

### When the top or bottom is too wide

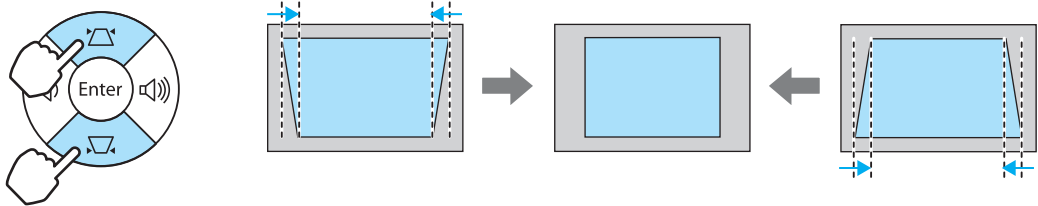



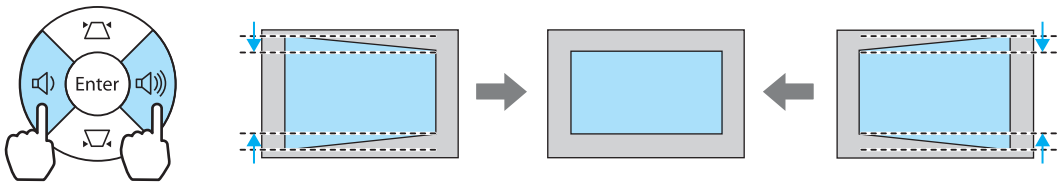

### When the left or right is too wide



- When you correct keystone distortion, the projected image may be reduced. Increase the projection distance to fit the projected screen to the screen size.
- You can also set H/V-Keystone from the Configuration menu. **Settings - H/V-Keystone - V-Keystone/H-Keystone** [p.79](#)
- You can make effective corrections within a projection angle range of 30° in any direction.

## Adjusting the Volume

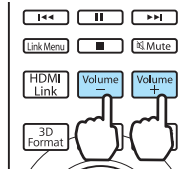

You can adjust the volume by using the   buttons on the remote control or the   buttons on the projector's control panel.

Remote control

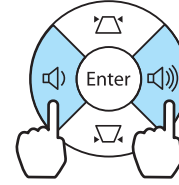

Control panel



- You can also adjust the volume from the Configuration menu.  **Settings - Audio** p.79
- Under normal conditions, you can adjust the volume of the projector's built-in speaker. However, by connecting an AV system to the projector and setting **HDMI Link** to **On** and **Audio Out Device** to **AV System**, you can adjust the AV system's volume when projecting from **HDMI1**, **HDMI2**, and **WirelessHD** sources.  p.68



### Caution

Do not start at high volume.



A sudden excessive volume may cause loss of hearing. Always lower the volume before powering off, so that you can power on and then gradually increase the volume.

## Hiding the Image and Muting the Audio Temporarily

You can use this to temporarily hide the image on the screen and mute the audio.

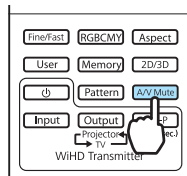
Press the  button to show or hide the image. The audio is also muted or played.



- For movies, because the movie continues to play even when it is hidden, you cannot return to the point at which you hid the image and muted the audio using the  button.
- To mute or play only the audio, press the  button.
- Under normal conditions, the audio of the projector's built-in speaker will be muted or played. However, by connecting an AV system to the projector and setting **HDMI Link** to **On** and **Audio Out Device** to **AV System**, you can adjust the AV system's volume when projecting from **HDMI1** and **HDMI2**.  p.68





# Adjusting the Image

## Selecting the Projection Quality (Color Mode)

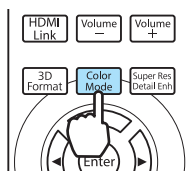

You can obtain the optimum image quality to suit your surroundings when projecting. The brightness of the image varies depending on the mode selected.

1 Press the  button.



You can make settings from the Configuration menu.  **Image - Color Mode** [p.75](#)

2 Select **Color Mode**.

Press the   buttons from the displayed menu to select **Color Mode**, and then press the  button to confirm the selection.

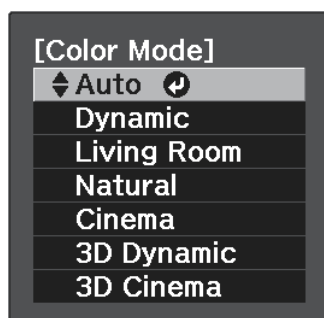

### When projecting 2D images

You can select **Auto**, **Dynamic**, **Living Room**, **Natural**, and **Cinema**. **3D Dynamic** and **3D Cinema** are grayed out and cannot be selected.

### When projecting 3D images

You can select **3D Dynamic** and **3D Cinema**.

**Auto**, **Dynamic**, **Living Room**, **Natural**, and **Cinema** are grayed out and cannot be selected.

Choices when projecting 2D images

Mode	Application
Auto	Sets the color mode automatically according to the surroundings. The optimum image quality is set according to the brightness of the room detected by the sensor (auto color adjustment function).
Dynamic	Ideal for use in a bright room.
Living Room	Ideal for use in a bright room. Images are clear and sharp.
Natural	Ideal for use in a dark room. We recommend performing color adjustment in this mode.
Cinema	Ideal for watching movies and concerts in a dark room.



Only when **Projection** is **Front, Auto** can be set. p.79

Choices when projecting 3D images

Mode	Application
3D Dynamic	For use when projecting 3D images. Images are bright and sharper than 3D Cinema.
3D Cinema	For use when projecting 3D images. Produces crisper colors than 3D Dynamic.

Switching the Screen Between Full and Zoom (Aspect)

You can change the input signal's type, aspect ratio, and resolution to match the **Aspect** of the projection screen.

The available **Aspect** varies depending on the image signal currently being projected.

**1** Press the **Aspect** button.

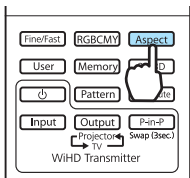

You can make settings from the Configuration menu. **Signal - Aspect** p.77

**2** Use the buttons to select the setting name, and then press the button to confirm the selection.

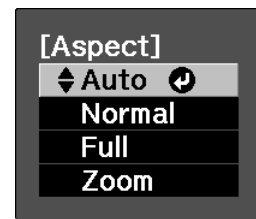

**Aspect** may not be available depending on the type of signal.

By normally selecting Auto, the optimum aspect is used to display the input signal. Change the setting if you want to use a different aspect.

The table below shows the image projected on a 16:9 screen.

Input Image	Setting Name (Aspect)		
	Normal	Full	Zoom
4:3 Images			
16:9 Images		When projecting 16:9 images, Full and Zoom cannot be selected.	
Images Recorded Using Squeeze			

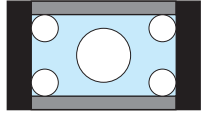
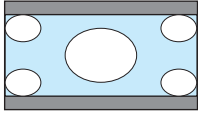
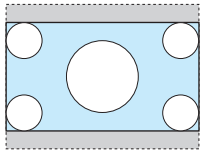
Input Image	Setting Name (Aspect)		
	Normal	Full	Zoom
Letterbox Images*			
Notes	Matches the vertical size of the projection panel. The aspect ratio differs depending on the input image.	Uses the entire projection panel.	Retains the aspect ratio of the input signal, and matches the horizontal size of the projection panel. The top and bottom of the image may be truncated.

\* The letterbox image used in this explanation is a 4:3 aspect ratio image displayed in 16:9 with black margins at the top and bottom for subtitle placement. The margins at the top and bottom of the screen image are used for subtitles.



Note that using the aspect ratio function of the projector to reduce, enlarge, or split the projected image for commercial purposes or for public viewing may infringe upon the rights of the copyright holder of that image based on copyright law.

# Absolute Color Adjustments

## Adjusting Hue, Saturation, and Brightness

You can adjust the hue, saturation, and brightness for each of the R (red), G (green), B (blue), C (cyan), M (magenta), and Y (yellow) colors.

Hue	Adjusts the overall color of the image to be blue, green, or red.
Saturation	Adjusts the overall vividness of the image.
Brightness	Adjusts the overall color brightness of the image.

1 Press the **RGBCMY** button.

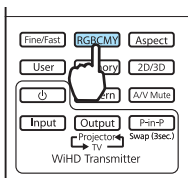

You can make settings from the Configuration menu. **Image - Advanced - RGBCMY p.75**

2 Use the buttons to select the color you want to adjust, and then press the button to confirm the selection.

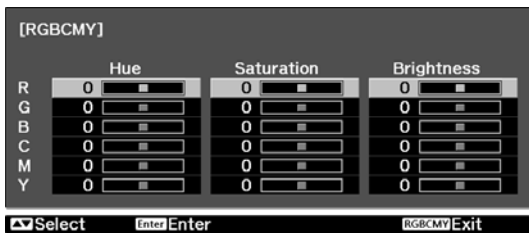

3 Use the buttons to select **Hue, Saturation, or Brightness**.

4 Use the buttons to make adjustments.

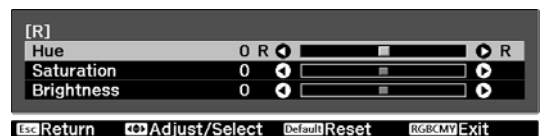

Press the button to adjust another color.

Press the button to return the adjustments to their default values.

5 Press the **RGBCMY** button to exit the menu.

## Adjusting the Gamma

You can adjust slight coloration differences that may occur due to the device being used when the image is displayed.

You can use one of the following two methods selected from the Configuration menu.

Setting Method	Menu Settings
Select and adjust the correction value	<b>Image - Advanced - Gamma</b>
Adjust using the gamma adjustment graph	<b>Image - Advanced - Gamma - Customized</b> - Color Tone Adjustment

**Select and adjust the correction value**

Select the adjustment value, and then press the **Enter** button to confirm the selection.

The larger the value, the lighter the dark portions of the image become, but bright areas may appear discolored. The upper part of the gamma adjustment graph becomes rounded.

The smaller the value, the darker the bright portions of the image become. The lower part of the gamma adjustment graph becomes rounded.

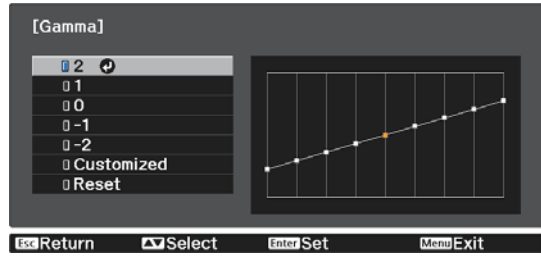

- The horizontal axis of the gamma adjustment graph shows the input signal level, and the vertical axis shows the output signal level.
- Press the **Default** button to return the adjustments to their default values.

**Adjust using the gamma adjustment graph**

Make the color tone adjustments while viewing the projected image.

**1** Use the **Left/Right** buttons to select the part you want to adjust from the graph.

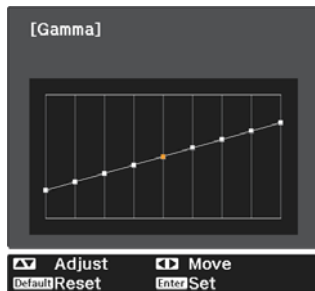

**2** Use the **Up/Down** buttons to adjust the brightness, and then press the **Enter** button to confirm the selection.

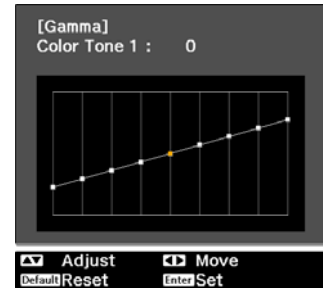

**Adjusting the RGB (Offset/Gain)**

For the image's brightness, you can adjust the dark areas (Offset) and the bright areas (Gain) for R (red), G (green), and B (blue). The image becomes brighter when moved to the right (positive) and darker when moved to the left (negative).

Offset	When the image is made brighter, shading for the darker sections is more vividly expressed. When the image is made darker, the image appears more full-bodied but shading for the darker sections is harder to distinguish.
Gain	When the image is made brighter, the bright sections become whiter and shading is lost. When the image is made darker, shading for the bright sections is more vividly expressed.

The menu is displayed in the following order.

**Image - Advanced - RGB**

Use the **Up/Down** buttons to select the item, and then use the **Left/Right** buttons to make the adjustments.







Press the  button to return the adjustments to their default values.

### Color Temp.

You can adjust the overall tint of the image. Make adjustments if the image is a little too blue or too red and so on.

The menu is displayed in the following order.

#### Image - Color Temp.

Use the   buttons to make adjustments.

Blue tints grow stronger as the value is increased, and red tints grow stronger as the value is reduced.





- The **Color Temp.** setting varies with the **Color Mode** setting.
- Press the  button to return the adjustments to their default values.

### Skin Tone

You can adjust the skin tone. Make adjustments if the skin tone is too red or too green and so on.

The menu is displayed in the following order.

#### Image - Skin Tone

Use the   buttons to make adjustments.

The image becomes greener when set to the right (positive) and redder when set to the left (negative).



Press the  button to return the adjustments to their default values.

# Detailed Image Adjustments

## Adjusting the Sharpness

You can make the image clearer. There are two types available, **Standard** and **Advanced** which allows you to make more detailed adjustments.

**Advanced** cannot be adjusted in the following situations.

- When a computer signal is being input
- When **Image Processing** is set to **Fast** in the **Signal** menu
- When projecting 3D images

The following shows the setting items and procedures for **Advanced**.

Thin Line Enhancement	Details such as hair and patterns on clothing are enhanced.
Thick Line Enhancement	Rough parts such as outlines for entire subjects or the background are enhanced, making the overall image clearer.
Vert. Line Enhancement	Enhances the image horizontally or vertically.
Horiz. Line Enhancement	

1 Press the  button.

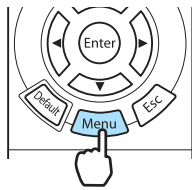





The Configuration menu is displayed.

2 Select **Image - Sharpness**.

The **Sharpness** adjustment screen is displayed.

3 Select **Advanced** at the top right of the screen, and then press the  button to confirm the selection.

The **Advanced** adjustment screen is displayed.

4 Use the   buttons to select the item, and then use the   buttons to make the adjustments.

The image is enhanced when moved to the right (positive) and softer when moved to the left (negative).

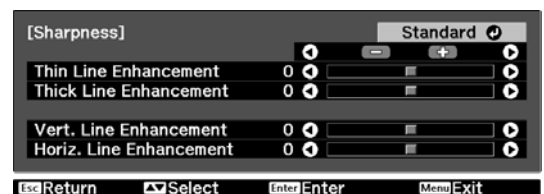

The upper + and - buttons adjust high and low areas simultaneously.

Press the  button to return the adjustments to their default values.

5 Press the  button to exit the menu.

## Setting Auto Iris

By automatically setting the luminance according to the brightness of the displayed image, it lets you enjoy deep and rich images.

You can select the luminance adjustment tracking for changes in brightness in the displayed image from **Normal** to **High Speed**.

(Depending on the image, you may hear the auto iris operating, but this is not a malfunction.)

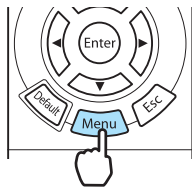

**1** Press the  button.



The Configuration menu is displayed.

**2** Select **Image - Auto Iris**.

The **Auto Iris** adjustment screen is displayed.

**3** Use the   buttons to select the item, and then press the  button to confirm the selection.

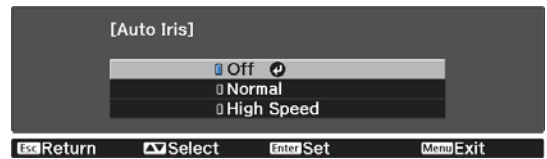

## Super-resolution and Detail Enhancement Functions

These functions improve a resolution by making fuzzy outlines clear and emphasizing the texture and material feel.

<p>Super-resolution</p>	<p>This setting sharpens blurred images, enhancing the apparent detail of the image by increasing the resolution of the image signal.</p> <p>Depending on the image, distortion at the edge of the image may be enhanced. If you notice any distortion, set it to "0".</p>
<p>Detail Enhancement</p>	<p>This setting enhances the contrast in an image to create the image with more emphatic texture and material feel.</p> <p>Depending on the image, a highlight may be noticeable at the border between colors. If it worries you, set a smaller value.</p>







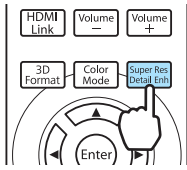

When the setting of Super-resolution is changed, the value of Detail Enhancement will also be changed.



1 Press the  button.



- You can make settings from the Configuration menu.  **Signal - Super-resolution** p.77
- This cannot be set when a computer image signal is being input.
- This cannot be set when converting 2D to 3D images.  **Signal - 3D Setup - 2D-to-3D Conversion** p.77
- When projecting 3D images, this setting is enabled only for 1080p/24 Hz/frame packing signals.

2 Use the   buttons to select **Super-resolution** or **Detail Enhancement**, and then use the   buttons to make the adjustments.

For Super-resolution, the higher the value, the stronger the effect.  
For Detail Enhancement, the higher the value, the more emphatic the texture.



3 Press the  button or the  button to exit the menu.

## Panel Alignment

Adjusts the pixel color shift of the LCD display.

1 Press the  button.

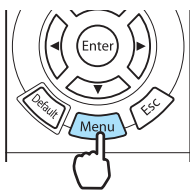



The Configuration menu is displayed.

2 Select **Settings - Panel Alignment**, and then press the  button to confirm the selection.

The **Panel Alignment** adjustment screen is displayed.

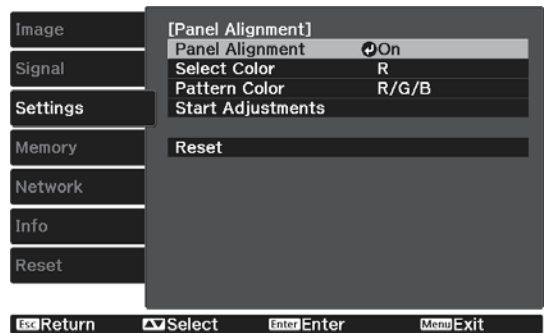
3 Set **Panel Alignment** to **On**.









 When set to **On**, the adjusted value is enabled. When set to **Off**, the corrected value returns to the default value.

4 In **Select Color**, select the color you want to adjust.



5 In **Pattern Color**, select the pattern (color combination) used for adjustments.

**6** Select **Start Adjustments**, and then press the  button to confirm the selection.

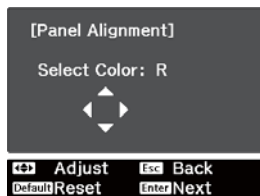

First, adjust the whole LCD display. When a message appears prompting you to start adjustments, press the  button to start them.





**7** Use the     buttons for adjustments, and then press the  button.



 To restore the values before the start of whole adjustment, press the  button.

**8** To make more detailed adjustments, select **Adjust the four corners**, and then press the  button to confirm.

-  To finish the adjustments, select **Exit**.
- To return to the Start Adjustments screen, press the  button.

**9** Use the     buttons to adjust, and then press the  button to move to the next adjustment point.

Adjustments are performed in four corners starting from the top-left corner.

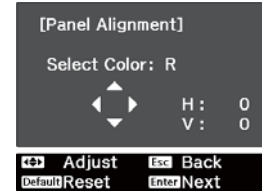

**10** After adjusting four corners, select **Exit**, and then press the  button to confirm.

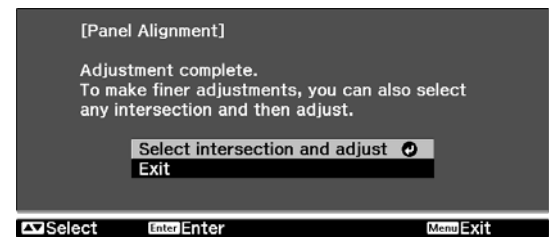

 If the four corners still need adjustments, select **Select intersection and adjust**, and then continue adjustments.

**11** Press the  button to exit the menu.

## Image Processing

Improves the response speed for images projected at high-speed, such as games.

This is only available when receiving a progressive signal input from the Component, Video, HDMI1, or HDMI2 ports, or from WirelessHD.

The  button toggles the mode between **Fine** and **Fast**.

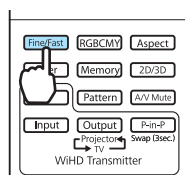



- You can make settings from the Configuration menu. 🖱️ **Signal - Advanced - Image Processing** [p.77](#)
- This does not support 3D images.
- If **Image Processing** is set to **Fast**, the following settings cannot be changed:
  - Noise Reduction** and **2D-to-3D Conversion** are fixed at Off.
  - Sharpness** is fixed at **Standard**.
  - Picture in Picture** cannot be used.

## Viewing the Image at the Saved Image Quality (Memory Function)

### Saving Function

You can save the adjustment values for some images and image quality settings in the Configuration menu for later use (Save Memory).

Because these saved adjustment values can be loaded from the remote control, you can easily switch to your preferred image quality (Load Memory).

The following Configuration menu functions can be saved.

Image ☞ p.75	Color Mode, Brightness, Contrast, Color Saturation, Tint, Skin Tone, Sharpness, Color Temp., Power Consumption, Auto Iris	
	Advanced	Gamma, Offset, Gain, Hue, Saturation, Brightness, EPSON Super White
Signal ☞ p.77	Deinterlacing, Motion Detection, Super-resolution	
	Advanced	Noise Reduction, Setup Level, Overscan, HDMI Video Range

### Saving a Memory

You can register a memory when **Color Mode** is set to anything except **Auto**.

1 Make settings that you want to save to the Configuration menu.

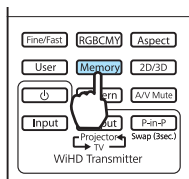

2 Press the **Memory** button.



3 Use the   buttons to select **Save Memory**, and then press the  button to confirm the selection.



The **Save Memory** screen is displayed.

4 Use the   buttons to select the memory name to be saved, and then press the  button to confirm the selection.

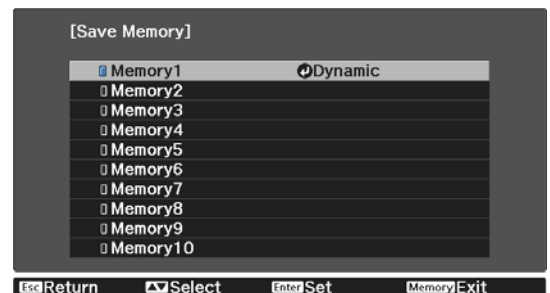

The current projector settings are saved to the memory.

If the mark on the left of the memory name is turned aqua, it means the memory has already been registered. When you select a registered memory, a message is displayed asking you to confirm that you want to overwrite the memory. If you select **Yes**, the previous content is erased and the current settings are saved.

### Loading a Memory

1 Press the  button, and then select **Load Memory**.

The **Load Memory** screen is displayed.

2 Select the target memory name.



- The color mode saved to the memory is displayed on the right.
- Depending on the input signal, part of the loaded memory item may not be applied to the projected image.
- Memories saved for 2D images can only be loaded when projecting 2D images. Memories saved for 3D images can only be loaded when projecting 3D images.

### Deleting a Saved Memory

1 Press the  button, and then select **Erase Memory**.

The **Erase Memory** screen is displayed.

2 Select the target memory name.

A confirmation message is displayed. If you select **Yes**, the content of the saved memory is erased.



If you want to erase all of the saved memories, go to **Reset - Reset Memory** on the Configuration menu.  [p.87](#)

### Renaming a Memory

You can rename each memory name using up to 12 characters. Giving the memory a name that is easy to remember is useful when loading the memory.

1 Press the  button, and then select **Rename Memory**.

The **Rename Memory** screen is displayed.

2 Select the target memory name.

The name list screen is displayed.





3 Select a displayed name or **Customized**.

To enter a name of your own, select **Customized**, and then go to step 4. If you select **Customized**, a keyboard is displayed.

If you select from the name list, check that the memory name has been changed.

4

## Enter a name.

Use the     buttons to select a character, and then press the  button to confirm the selection. Enter up to 12 characters.

When you have finished entering the name, select **Finish**.

The memory name is changed.

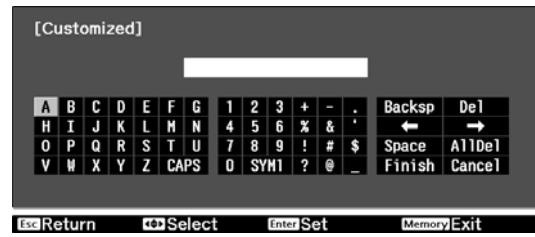



# Enjoying 3D Images

## Setting 3D Images

Set the source to HDMI1, HDMI2, or WirelessHD (EH-TW6600W only) to view 3D images.

The projector supports following 3D formats.

- Frame Packing
- Side by Side
- Top and Bottom

### ■ When the projector detects a 3D format

The projector automatically projects a 3D image when detecting a 3D format.

### ■ When the projector cannot detect a 3D format

Some 3D TV broadcasts may not contain 3D format signals. If this happens, set the 3D format manually. Press the  button to set the 3D format on the AV device.

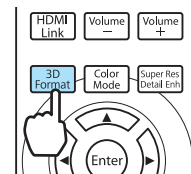

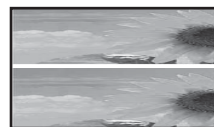
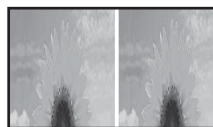

- When viewing 3D images with an AV amplifier connected, use a 3D compatible AV amplifier.
- For details on 3D format settings on the AV device, see the documentation supplied with the AV device.
- When the 3D format has not been correctly set up, an image will not be correctly projected as shown below.





### ■ If the 3D image cannot be viewed

Check the following if the 3D effect is not displayed correctly, even after setting the 3D formats.

- The synchronization timing for the 3D Glasses may have been inversed. Inverse the synchronization using **Inverse 3D Glasses**, and then try again.  **Signal - 3D Setup - Inverse 3D Glasses** p.77
- The image is not displayed in 3D if **3D Display** is set to **Off**. Press the  button on the remote control.  **Signal - 3D Setup - 3D Display** p.77



- How a 3D image is perceived varies depending on the individual.
- When a 3D image is displayed, a warning about viewing 3D images is displayed. You can turn off this warning by setting **3D Viewing Notice** to **Off**.  **Signal - 3D Setup - 3D Viewing Notice** p.77
- You can also convert 2D images to 3D images.  p.52
- During 3D projection, the following Configuration menu functions cannot be changed. Aspect (set to Normal), Noise Reduction (set to Off), Overscan (set to Off), Super-resolution, Image Processing, Advanced - Sharpness, Picture in Picture
- How the 3D image is viewed may change depending on the temperature of the surroundings and how long the lamp has been used. Refrain from using the projector if the image is not projected normally.

## Using 3D Glasses

Use the supplied or optional 3D Glasses (ELPGS03) to view 3D images. Depending on the model, 3D Glasses may not be supplied.

 The 3D Glasses come with protective stickers. Remove the protective stickers before use.

### ■ Charging the 3D Glasses

The following charging methods are available, depending on the model of 3D Glasses being used. If you have a WirelessHD Transmitter, you can use it to charge the glasses. If you do not have a WirelessHD Transmitter, you can charge by using an optional USB Charging Adapter. You can also charge by connecting the 3D Glasses to the USB port (TypeA) on the rear of the projector with the USB cable (only when the projector is turned on).

#### Charging using the WirelessHD Transmitter

Use the USB cable to connect the 3D Glasses to the WirelessHD Transmitter.

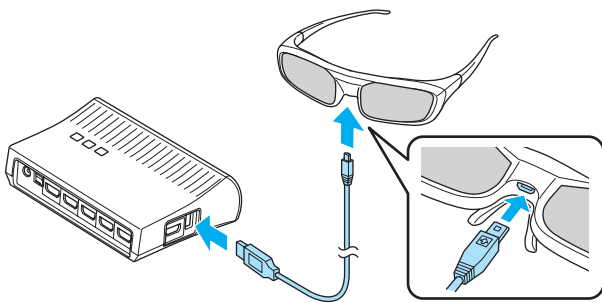



When a cable is connected to the HDMI5 port, the WirelessHD Transmitter cannot charge 3D glasses.

#### Charging using the USB Charging Adapter

Use the USB cable to connect the 3D Glasses to the optional USB Charging Adapter, and then

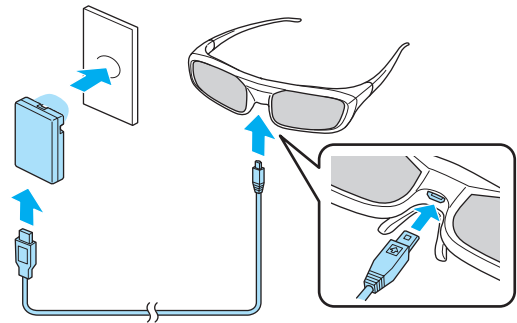
connect the USB Charging Adapter to an electrical outlet.



 The approximate charging and usage times are as follows:

Charging time	Usage time
3 minutes	Approx. 3 hours
50 minutes	Approx. 40 hours

### Attention

- Only connect to an electrical outlet that uses the voltage displayed on the 3D Glasses.
- Note the following points when handling the supplied microUSB cable.
  - You should not bend, twist, or pull the cable with too much force.
  - You should not modify the cable.
  - You should not perform wiring near an electric heater.
  - You should not use the cable if it is damaged.

### ■ Pairing 3D Glasses

To create 3D images, the 3D Glasses need to be paired with the projector.



Press the [Pairing] button for a while on the 3D Glasses to start pairing.

**1** Turn on the 3D Glasses by sliding the [Power] switch to On.

The indicator turns on for several seconds, and then turns off.

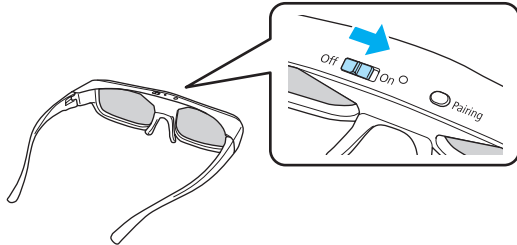

**2** Press and hold the button for three seconds.

The indicator flashes green and red in turn. If pairing has been performed correctly, the indicator turns on for ten seconds and then turns off.



- For 3D Glasses that have not been used, pairing is performed when the 3D Glasses are turned on. You do not need to perform pairing if 3D images can already be viewed correctly.
- Once pairing has been performed, you can view 3D images the next time the devices are turned on.
- You can perform pairing within a range of three meters from the projector. While pairing is being performed, make sure you stay within a range of three meters from the projector. Otherwise, pairing will fail.
- If synchronization cannot be performed within 30 seconds, pairing is automatically canceled. When pairing is cancelled, 3D images cannot be viewed because pairing fails.

## ■ Wearing the 3D Glasses

**1** Turn on the 3D Glasses by sliding the [Power] switch to On.

The indicator turns on for several seconds, and then turns off.

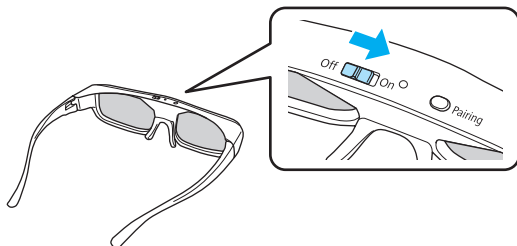

**2** Put on the 3D Glasses and enjoy the show.



- When you have finished using the 3D Glasses, turn them off by sliding the [Power] switch to Off.
- If the 3D Glasses are not used for at least 30 seconds, they turn off automatically. To turn the 3D Glasses back on, slide the [Power] switch to Off, and then slide it back to On.
- You need more pairs of optional 3D Glasses if more than one person will be viewing the 3D image. [p.109](#)

■ Reading the indicator on the 3D Glasses

You can check the status of the 3D Glasses by whether its indicator is lit or flashing.

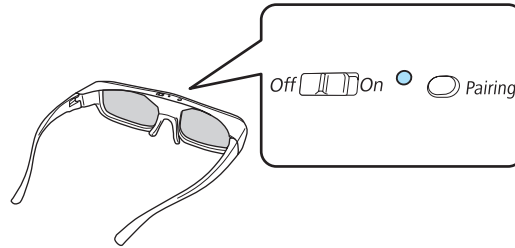

Indicators	Status
Flashes red two times ×5	Weak battery
Lit red	Charging
Lit green	Charging completed
Flashes green and red in turn	Pairing
Lit green for ten seconds and then turns off	Power on or pairing succeeded

Range for Viewing 3D Images

This projector allows you to view 3D images within the range shown in the figure below. You can view 3D images within a range of 10 meters from the projector.

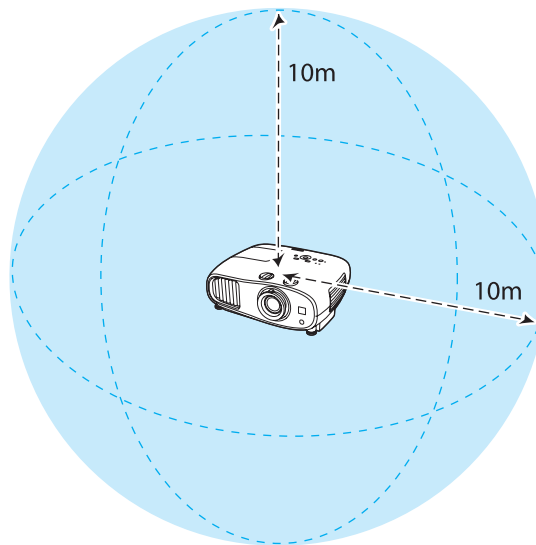

- 3D images may not be displayed correctly if there is any interference from other Bluetooth communication devices. Do not use these devices at the same time.
- The communication method for 3D Glasses uses the same frequency (2.4 GHz) as wireless LAN (IEEE802.11b/g) or microwave ovens. Therefore, if these devices are used at the same time, radio wave interference may occur, the image may be interrupted, or communication may not be possible. If you do need to use these devices at the same time, make sure there is enough distance between them and the projector.
- The 3D Glasses for this projector are Bluetooth active shutter 3D glasses.

## Warnings Regarding Viewing 3D Images

Note the following important points when viewing 3D images.

### Warning

#### Disassembling or remodeling

- Do not disassemble or remodel the 3D Glasses.  
This could cause a fire to occur or the images to appear abnormal when viewing, causing you to feel unwell.

#### Storage locations

- Do not leave the 3D Glasses or the supplied parts within reach of children.  
They could be accidentally swallowed. If anything is accidentally swallowed, contact a doctor immediately.

#### Wireless (Bluetooth) communication

- Electromagnetic interference may cause medical equipment to malfunction. Before using the device, make sure there is no medical equipment in the vicinity.
- Electromagnetic interference may cause automatically controlled equipment to malfunction which could cause an accident. Do not use the device near automatically controlled equipment such as automatic doors or fire alarms.

#### Heating

- Do not place the 3D Glasses in a fire, on a heat source, or leave them unattended in a location subject to high temperatures. Because this device has a built-in rechargeable lithium battery, it could cause burns or a fire if it ignites or explodes.

#### Charging

- When charging, connect the supplied cable to the USB port designated by Epson. Charging should be performed either via WirelessHD, this projector, or the genuine adapter. Do not charge using other devices as it may cause the battery to leak, overheat, or explode.
- Only use the supplied charging cable to charge the 3D Glasses. Otherwise, it could overheat, ignite, or explode.

### Caution

#### 3D Glasses

- Do not drop or press too forcefully on the 3D Glasses.  
If the glass sections and so on are broken, an injury could occur. Store the glasses in the soft glasses case.
- Be careful of the edges of the frame when wearing the 3D Glasses.  
If it pokes your eye and so on, an injury could occur.
- Do not place your finger in any of the moving sections (such as the hinges) of the 3D Glasses.  
Otherwise an injury could occur.

 **Caution**

Wearing 3D Glasses

- Make sure you wear the 3D Glasses correctly.  
Do not wear the 3D Glasses upside down.  
If the image is not displayed correctly into the right and left eyes, it could cause you to feel unwell.
- Do not wear the glasses unless you are viewing a 3D image.
- How a 3D image is perceived varies depending on the individual. Stop using the 3D function if you feel strange or cannot see in 3D.  
Continuing to view the 3D images could cause you to feel unwell.
- Stop wearing the 3D Glasses immediately if they seem abnormal or a malfunction occurs.  
Continuing to wear the 3D Glasses could cause an injury or cause you to feel unwell.
- Stop wearing the 3D Glasses if your ears, nose, or temples become red, painful, or itchy.  
Continuing to wear the 3D Glasses could cause you to feel unwell.
- Stop wearing the 3D Glasses if your skin feels unusual when wearing the glasses.  
In some very rare cases the paint or materials used in the 3D Glasses could cause an allergic reaction.

 **Caution**

Viewing Time

- When viewing 3D images, always take periodic breaks during extended viewing.  
Long periods of viewing 3D images may cause eye fatigue.  
The amount of time and frequency of such breaks varies from person to person. If your eyes still feel tired or uncomfortable even after taking a break from viewing, stop viewing immediately.

 **Caution**

Watching 3D Images

- If your eyes feel fatigued or uncomfortable when viewing 3D images, stop viewing immediately.  
Continuing to view the 3D images could cause you to feel unwell.
- When viewing 3D images, be sure to always wear 3D Glasses. Do not attempt to view 3D images without 3D Glasses.  
Doing so could cause you to feel unwell.
- Do not place any breakable or fragile objects around you when using 3D Glasses.  
3D images may cause you to move your body involuntarily, resulting in damage to nearby items or personal injury.
- Only wear 3D Glasses when viewing 3D images. Do not move around while wearing 3D Glasses.  
Your vision may appear darker than normal, causing you to fall or injure yourself.
- Try to stay as level with the viewing screen as possible when viewing 3D images.  
Viewing 3D images at an angle reduces the 3D effect and may cause you to feel unwell due to unintended color changes.
- If using 3D Glasses in a room with fluorescent or LED lighting, you may see flashing or flickering throughout the room. If this should occur, reduce the lighting until the flickering goes away or turn off the lights completely when viewing 3D images. In some very rare cases, this flickering could trigger seizures or fainting for some individuals. If you begin to feel uncomfortable or unwell at any time when viewing 3D images, stop immediately.
- Stay at least three times the height of the screen away from the screen when viewing 3D images.  
The recommended viewing distance for an 80-inch screen is at least 3 meters, and at least 3.6 meters for a 100-inch screen.  
Sitting or standing any closer than the recommended viewing distance may result in eye fatigue.

**Caution**

Health Risks

- You should not use 3D Glasses if you are sensitive to light, have a heart condition, or are unwell. Doing so could aggravate your pre-existing conditions.

**Caution**

Recommended Age of Use

- The minimum recommended age to view 3D images is six years old.
- Children under the age of six are still developing and viewing 3D images may cause complications. Consult your doctor if you have any concerns.
- Children viewing 3D images through 3D Glasses should always be accompanied by an adult. It is often difficult to tell when a child is feeling tired or uncomfortable, which could result in them feeling suddenly unwell. Always check with your child to ensure that they are not experiencing any eye fatigue during viewing.

**Converting 2D Images to 3D and Viewing**

You can convert 2D images from HDMI1, HDMI2, or WirelessHD (EH-TW6600W only).

**1** Press the **Menu** button.

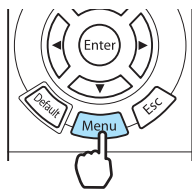

The Configuration menu is displayed.

**2** Select **Signal - 3D Setup**, and then press the **Enter** button to confirm the selection.

The **3D Setup** screen is displayed.

**3** Select **2D-to-3D Conversion**, and then press the **Enter** button to confirm the selection.

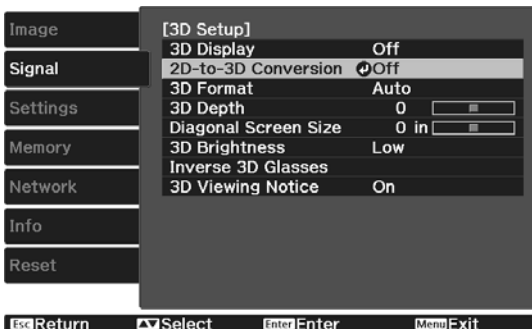

**4** Select the strength of the 3D effect, and then press the **Enter** button to confirm the selection.

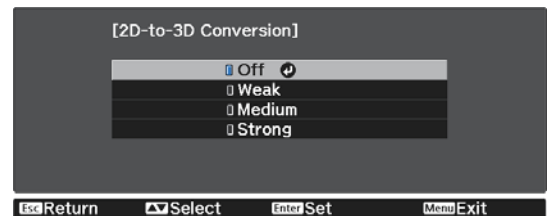

**5** Press the **2D/3D** button to turn **3D Display** to **On**.

The **2D/3D** button toggles **3D Display** between **On** and **Off**.

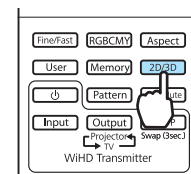



- When using **2D-to-3D Conversion**, set **3D Format** to **Auto** or **2D**. 🖱️ **Signal - 3D Setup - 3D Format** [p.77](#)
- If **Image Processing** is set to **Fast**, you cannot adjust **2D-to-3D Conversion**. 🖱️ **Signal - Advanced - Image Processing** [p.77](#)

# Connecting with WirelessHD (EH-TW6600W Only)

## Installing the WirelessHD Transmitter

You can use the supplied WirelessHD Transmitter to wirelessly receive image and sound data.

This is useful when the projector cannot be setup near your AV devices as you can connect the devices to the projector without using cables.



You can use the WirelessHD Transmitter in the following ways.

- You can connect up to five AV devices at the same time, and switch images using the remote control.
- As well as the projector, you can connect another monitor device, such as a television, to the Output port, and then switch the output using the remote control.
- This allows other monitor devices connected to the Output port to project images from the connected AV device, even if the projector is off.
- You can connect smart devices and tablets that support MHL, and then project images from the connected MHL device. You can also operate MHL devices from the projector's remote control, as well as charge the MHL device.

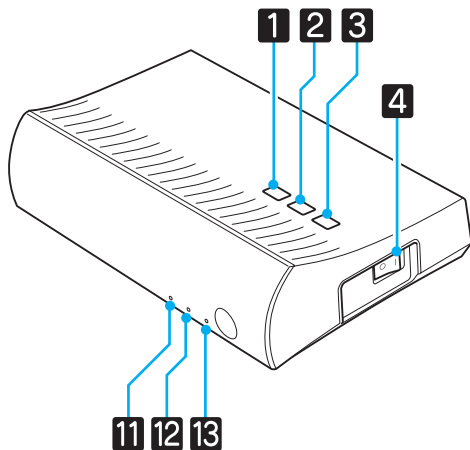

### WirelessHD Transmitter part names

Front

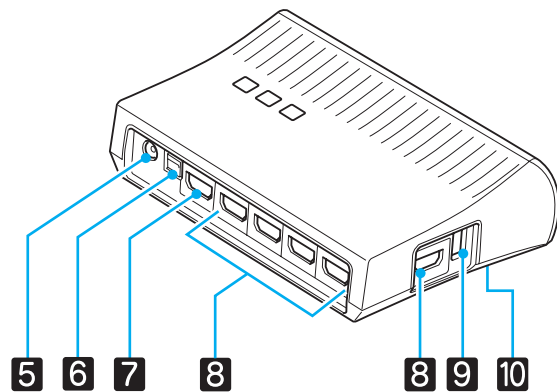

Rear



Name		Function
1	⏻ button	Turns the transmitter on or off. This performs the same function as the  button for WiHD Transmitter control on the lower section of the remote control.
2	Input button	Changes to the image from each input port. This performs the same function as the  button for WiHD Transmitter control on the lower section of the remote control.
3	Output button	Switches the output image to the Wireless or Output port. This performs the same function as the  button for WiHD Transmitter control on the lower section of the remote control.
4	Main power switch	Turns the main power for the transmitter on or off.
5	AC adapter port	Connects the AC adapter.
6	Optical Audio-Out port	Connects to audio devices equipped with an optical digital audio input port.
7	HDMI Output port	Connects to monitor devices, such as televisions. You can switch the output using the Output button.
8	HDMI Input port	Connects to the AV device you want to playback. You can switch the input image using the Input button.  The HDMI5 port of the unit meets the MHL standards. You can play content from MHL compatible smart devices or tablets connected with an MHL cable.
9	3D Glasses charging port	Connects a USB cable to charge the 3D Glasses.
10	Setup button	This is the button on the back of the WirelessHD Transmitter. It is used for setting the WirelessHD Transmitter.
11	⏻ indicator (orange/green)	Lit when the WirelessHD Transmitter is on. Lit orange when standing by, and green when operating (receiving or transmitting images).
12	WiHD indicator (orange)	Indicates the communication status for the WirelessHD. <ul style="list-style-type: none"> <li>• Lit when wirelessly transmitting images to the projector.</li> <li>• Off when outputting to the Output port.</li> </ul>
13	Link indicator (orange)	Indicates the connection status with the projector. <ul style="list-style-type: none"> <li>• Turns on when connected to the projector.</li> <li>• Flashes when searching for a projector.</li> <li>• Flashes slowly when standing by in power saving status.</li> </ul>



- The receiver is located within the intake vent of the projector and therefore cannot receive any signals directly from the rear. Set up so that the front of the projector is facing the WirelessHD Transmitter. Also, make sure that the air intake vent on the left-hand side of the projector is not covered.
- Place the WirelessHD Transmitter on a level surface facing towards the projector.
- You can view the signal strength from the **WirelessHD** settings menu.  **Settings - WirelessHD - Video Reception** [p.79](#)



## WirelessHD Transmitter connection example and signal flow

### Connection example 1: Viewing without an AV amplifier

Connect a device to WirelessHD Transmitter without using an AV amplifier, and connect the sound bars and so on to the Optical Audio-Out port to output audio.

When outputting audio from a connected device, you need an optical digital audio cable.

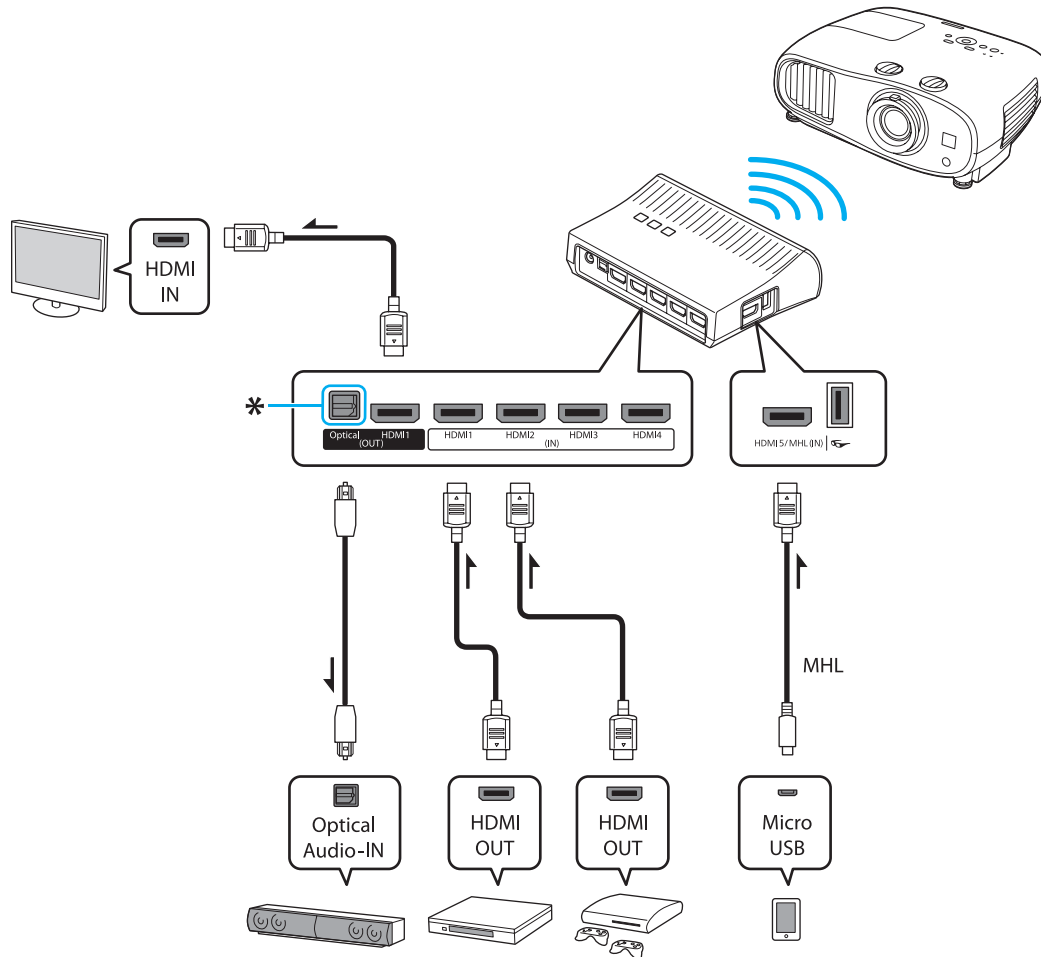

\* When connecting a device, such as a sound bar, to the Optical Audio-Out port on the WirelessHD Transmitter, check that **Audio Out Device** is set to **WirelessHD Transmitter**. **Settings - HDMI Link - Audio Out Device** [p.79](#)

### Connection example 2: Viewing with a connected AV amplifier

The audio from the device connected to the AV amplifier is output from the amplifier's audio-out port without passing through the WirelessHD Transmitter.

When outputting audio from a device connected with an MHL cable, you need an optical digital audio cable.

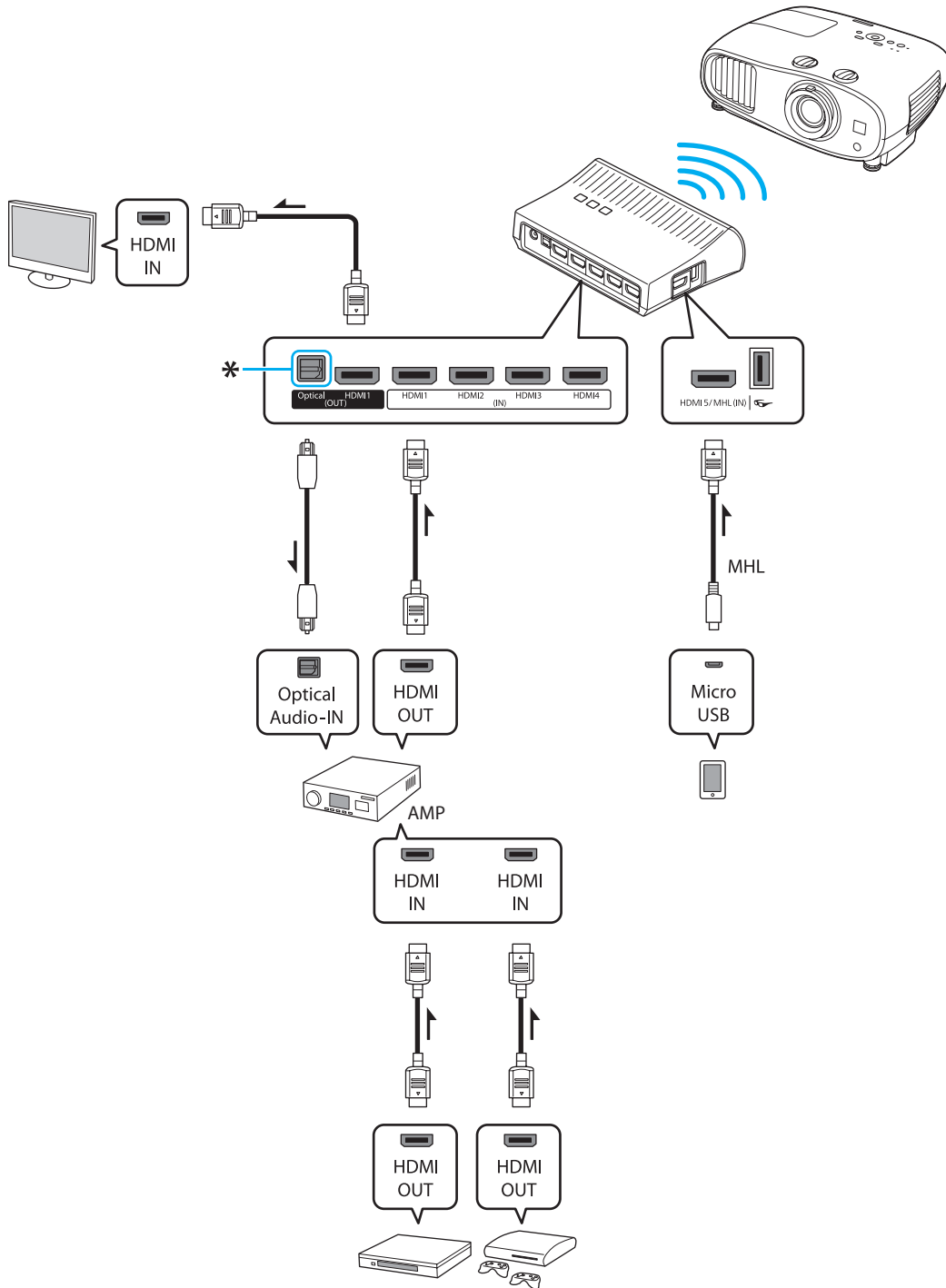

\* When connecting an MHL compatible smart device to the HDMI5 port with an MHL cable, you must connect the AV amplifier to the Optical Audio-Out port on the WirelessHD Transmitter in order to output the audio. Also make sure that **Audio Out Device** is set to **AV System**. [Settings - HDMI Link - Audio Out Device p.79](#) The audio output method to an AV amplifier may be restricted by the specifications of the monitor device, such as a television, connected to the Output port. For more information on audio output settings, see the documentation supplied with the AV device.

## Setting the WirelessHD Transmitter

**1** Set up the WirelessHD Transmitter connected to the projector so that they are facing each other. [p.61](#)

- The receiver is located at the front of the projector and therefore cannot receive any signals directly from the rear. Set up so that the front of the projector is facing the WirelessHD Transmitter. Also, make sure that the receiver is not covered.
- Place the WirelessHD Transmitter on a level surface facing towards the projector.

**2** Connect the WirelessHD Transmitter to an electrical outlet using the supplied AC adapter.

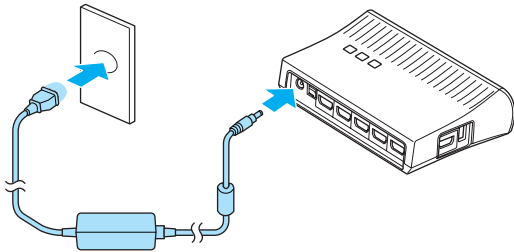

**3** Using an HDMI cable, connect the AV device you want to use to the Input port on the WirelessHD Transmitter. You can connect up to five multi-media players.

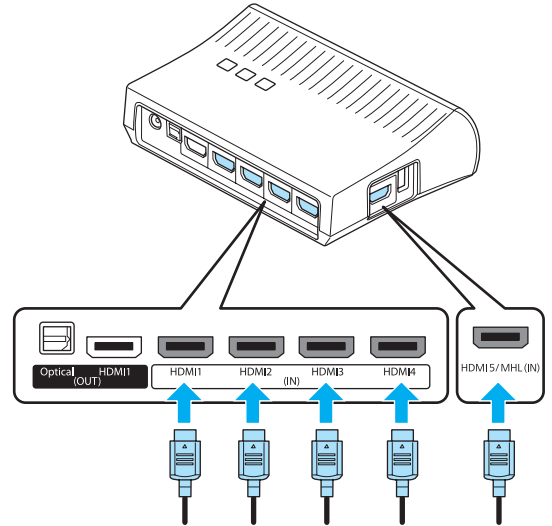

- You can connect another monitor device, such as a television, to the Output port on the WirelessHD Transmitter. You can switch between output images using the remote control. [p.63](#)
- The HDMI5 port of the WirelessHD Transmitter supports the MHL input signal. You can play content from MHL compatible smart devices or tablets connected with an MHL cable.
- If the following message is displayed when you connect an MHL device, the device has been connected to a port other than the HDMI5 port, or the connected device is not compatible with MHL.  
**"No Signal"**
- You can use the HDMI link function even when using the WirelessHD Transmitter. [p.68](#)

## Projecting Images

**1** Start playback on the AV device, and then turn on the projector and the WirelessHD Transmitter.

The  indicator on the WirelessHD Transmitter turns on.

**2** Check the status of the WiHD indicator on the WirelessHD Transmitter.

If the WiHD indicator is on, go to the next step.

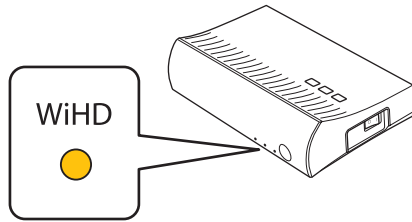

If the indicator is off, press the  button on the remote control or the WirelessHD Transmitter.

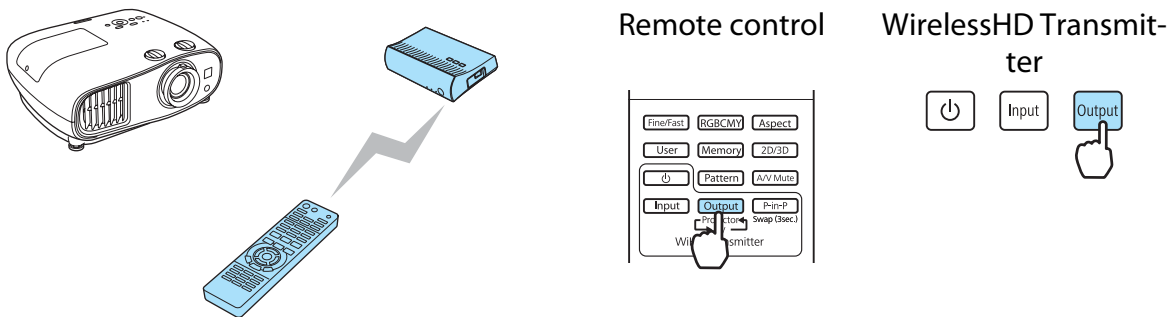

Make sure you point the remote control at the WirelessHD Transmitter when using the  button on the remote control.

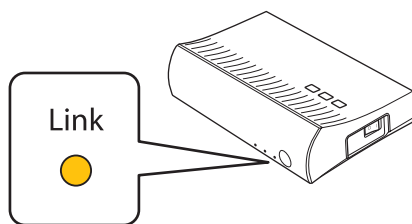

**3** Check the status of the Link indicator on the WirelessHD Transmitter.

If the WirelessHD Transmitter is connected to the projector, the Link indicator flashes and then remains on.



-  If the indicator continues to flash slowly, the WirelessHD Transmitter cannot connect to the projector and has entered standby status. Make sure the projector has been setup correctly, such as turning on the power and so on.
- You can view the signal strength while images are being projected from the **WirelessHD** settings menu.  **Settings - WirelessHD - Video Reception** [p.79](#)

**4** If projection does not start, press the **WirelessHD** button on the remote control to change the source.

Make sure you point the remote control at the projector when using the **WirelessHD** button on the remote control.

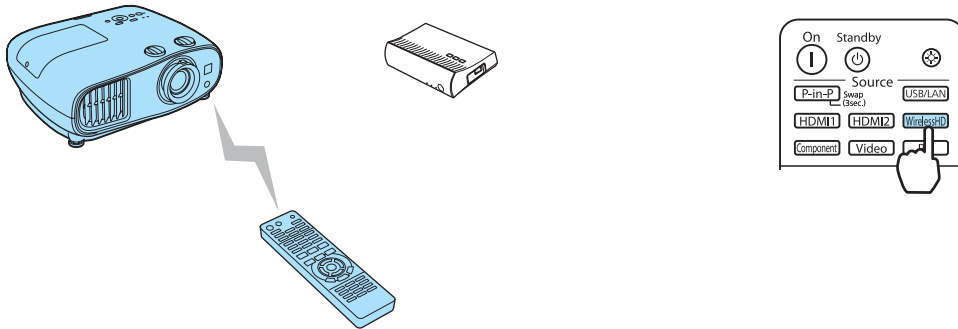

Projection starts.

**5** When connecting two or more AV devices to the WirelessHD Transmitter, press the **Input** button to switch images. [p.65](#)



- When receiving WirelessHD images, make sure **WirelessHD** is set to **On** from the Configuration menu. [Settings - WirelessHD - WirelessHD p.79](#)
- Make sure you turn off the WirelessHD Transmitter if it is not going to be used for an extended period.

### WirelessHD Settings Menu

**1** Press the **Menu** button.  
The Configuration menu is displayed.

**2** Select **Settings - WirelessHD**, and then press the **Enter** button to confirm the selection.

The **WirelessHD** settings screen is displayed.

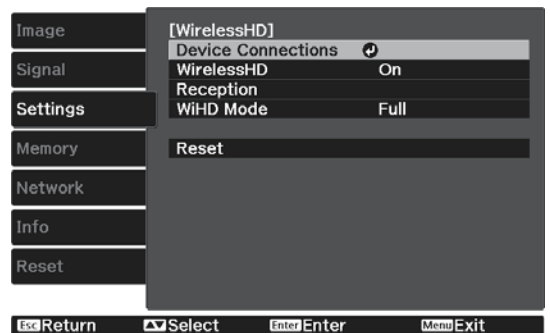

**3** Make settings for each of the displayed functions.



Available functions on the **WirelessHD** settings menu

Function	Explanation
Device Connections	Displays a list of available WirelessHD devices that can be connected. The device names and MAC addresses (device numbers) are displayed in the list. The MAC address is displayed on the label on the base.
WirelessHD	Enables or disables the WirelessHD function.
Video Reception	Displays the reception for the image being projected.
WiHD Mode	Use <b>Full</b> for most situations. <b>Full</b> mode uses the maximum video bandwidth at all times. <b>Dynamic</b> mode extends wireless ranges while optimally adjusting video bandwidth. Set to <b>Dynamic</b> if the image is interrupted due to weak signals and other causes.

Function	Explanation
Reset	Resets <b>WirelessHD</b> settings to their default settings.

 Even when the WirelessHD Transmitter and the projector are connected, 0% is displayed as the **Video Reception** when no image signal is being input. Check the communication status using the Link indicator.  [p.54](#)

## WirelessHD Transmission Range

The following shows the WirelessHD transmission range. Make sure you set up the WirelessHD Transmitter so that it faces the projector.

Horizontal direction (when **WiHD Mode** is set to **Full**)

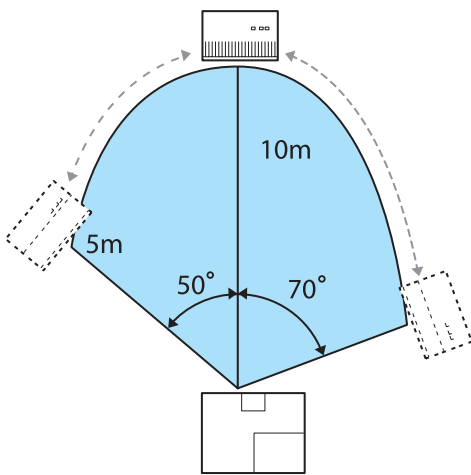

Horizontal direction (when **WiHD Mode** is set to **Dynamic**)

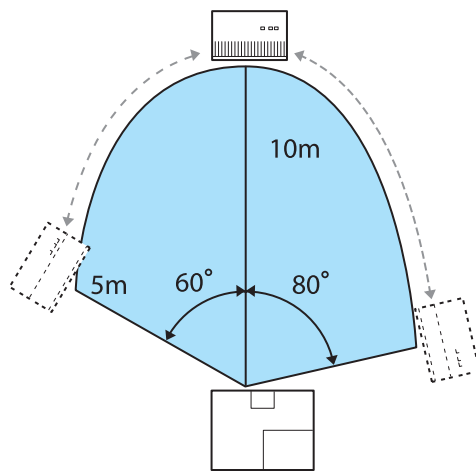

Vertical direction (suspended from a ceiling)

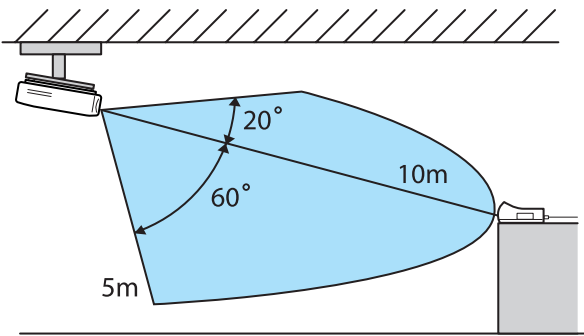

Vertical direction (suspended from a ceiling)

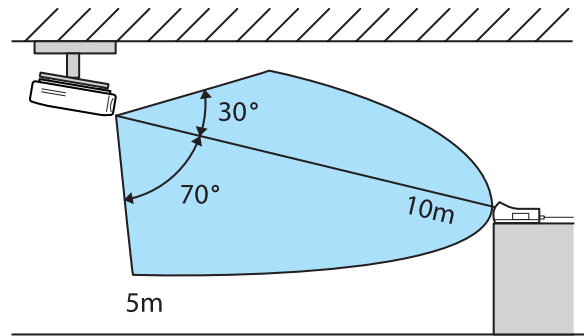

Vertical direction (placed on a table and so on)

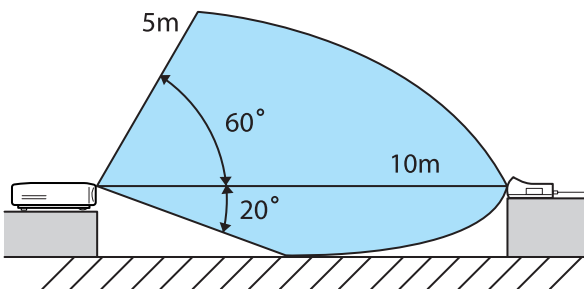

Vertical direction (placed on a table and so on)

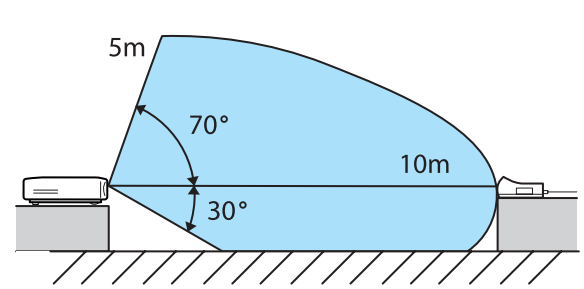



- The wireless transmission range varies depending on the placement and material of the surrounding furniture and walls. The values given here are for your reference only.
- The projector cannot communicate through walls.
- The antennas are built-into the front of the projector and the WirelessHD Transmitter. Make sure the antennas face each other (face the front) when setting up the devices.
- Do not place any object over the front side of the projector and WirelessHD Transmitter. Doing so may interfere with the image or prevent it from being displayed. Install so that the signal from the front of the transmitter is not interrupted.
- Do not install the transmitter on a metal shelf. The metal may make the signal unstable. Install on a shelf made from wood etc.
- When checking operations, place the projector and the WirelessHD Transmitter close to each other, and make sure there are no other projectors operating in the vicinity.
- Depending on the reception strength, the image's color information may be automatically discarded to avoid any interruptions and maintain a constant connection. To avoid any deterioration in image quality, adjust the position of the WirelessHD Transmitter so that the **Video Reception** is as strong as possible.

## Operating the Remote Control

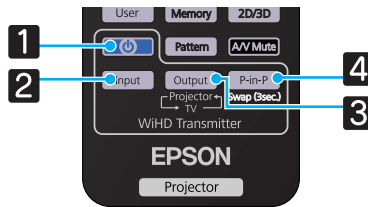

Name		Function
<b>1</b>		Turns the power for the WirelessHD Transmitter on or off.
<b>2</b>	Input	Switches the image source for the AV device connected to the WirelessHD Transmitter. <a href="#">p.65</a>
<b>3</b>	Output	Switches the output image between a monitor device, such as a television, connected to the Output port on the WirelessHD Transmitter and the projector. <a href="#">p.63</a>
<b>4</b>	P-in-P	Allows you to simultaneously project two image sources, one in the main screen and the other in the sub screen. (Picture in Picture) <a href="#">p.67</a>



Point the remote control towards the WirelessHD Transmitter.

## Remote Control Operating Range

The following shows the operating range between the remote control and the WirelessHD Transmitter.

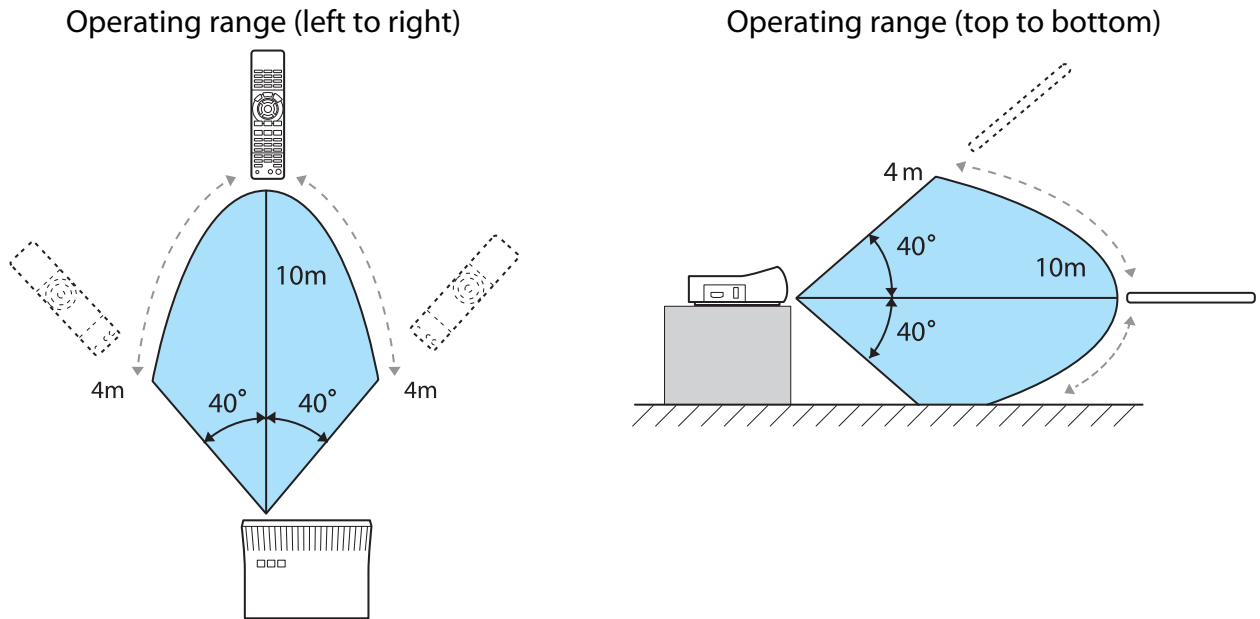

## Switching the Input and Output

With the WirelessHD Transmitter, you can connect and switch between up to five multi-media players (input devices to be played back) and one monitor device (a monitor device displaying an image, such as a television).



Point the remote control at the WirelessHD Transmitter and press its **Input** button to switch between input devices and its **Output** button to switch between output devices.

### Switching the target image

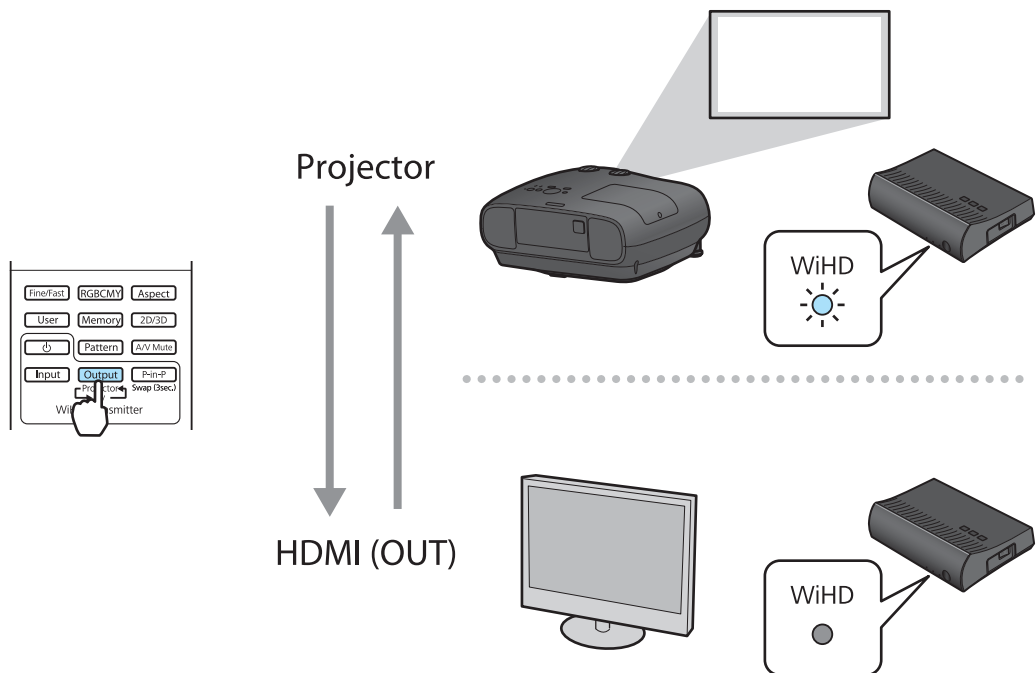
You can switch between a monitor device, such as a television, connected to the Output port on the WirelessHD Transmitter and the projector.





- 1 Turn on the projector or the monitor device, such as a television.
- 2 Turn on the WirelessHD Transmitter.  
The  indicator on the WirelessHD Transmitter turns on.
- 3 Point the remote control at the WirelessHD Transmitter, and then press the  button.

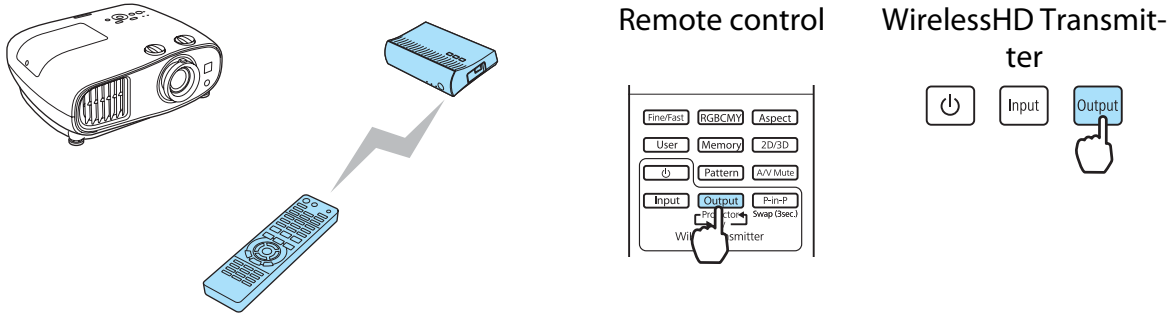

Depending on the output target, the WiHD indicator on the WirelessHD Transmitter indicates the following status. The output target projected last time is projected the next time the projector is turned on.

On: The image is being output to the projector.

Off: The image is being output to the monitor device.

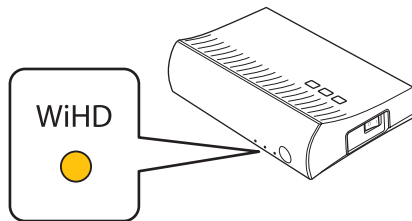

You can switch to the other monitor device even when the projector is off.

## Switching the image source

You can switch the image source for the AV device connected to the WirelessHD Transmitter. When switching, each input source is displayed on one screen as a preview. This allows you to switch easily between image sources even when two or more devices are connected using HDMI.

The projector uses Insta Prevue Technology from Silicon Image, Inc.

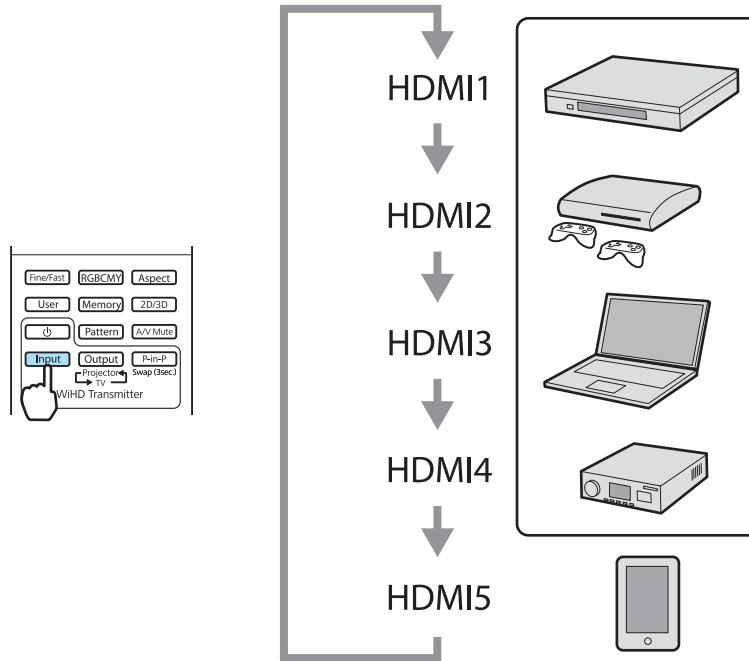

- 1 Point the remote control at the WirelessHD Transmitter, and then press the **Input** button.

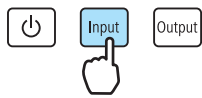
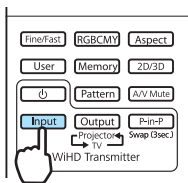
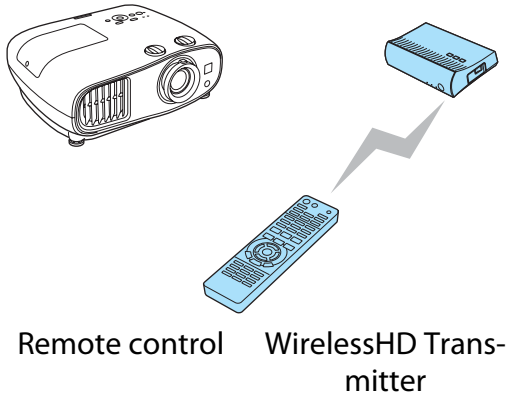

Displays the sub-screen (small screen) for the connected device.

Ex.) When projecting images for the device connected to the HDMI2 port

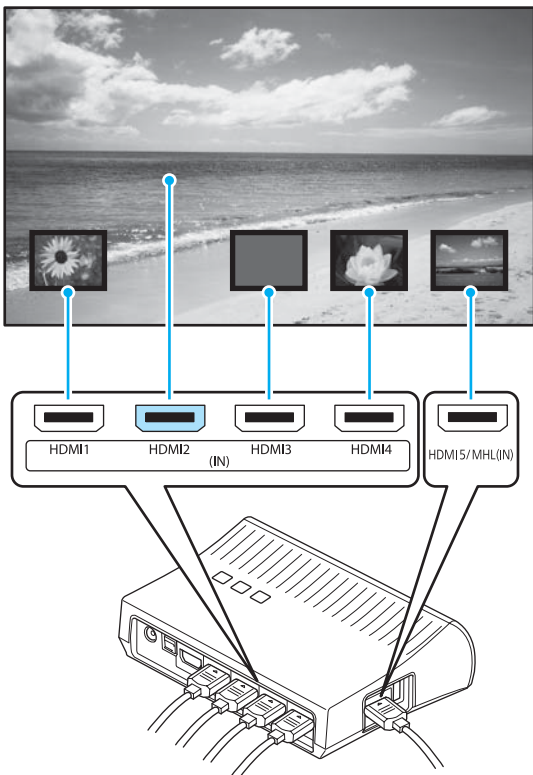

- 2 The target screen changes each time you press the **Input** button.

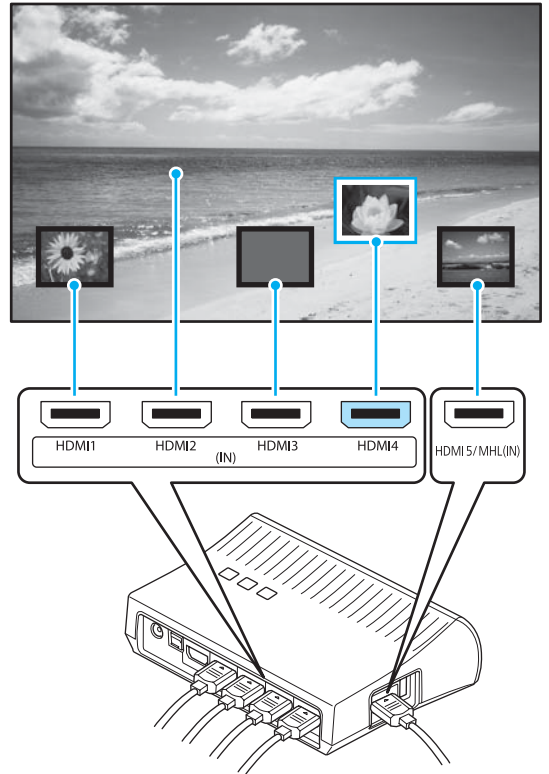

- 3 After selecting the target screen, please wait for a moment.

The projected image is switched.

 The screen that is not receiving an image signal is displayed in blue or black.

Ex.) When images for the device connected to the HDMI2 port are not displayed



The connected AV device is not turned on, or the cables are not connected correctly. Check that the AV device is turned on, or all the cables required for projection are securely connected.

## Displaying as a Sub-Screen

- 1** Point the remote control at the WirelessHD Transmitter, and then press the **P-in-P** button.

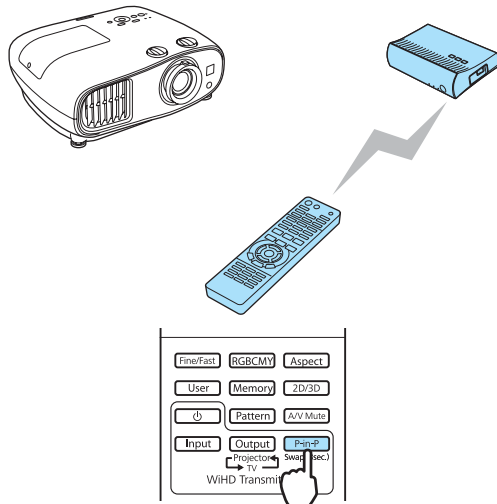

Displays the sub-screen (small screen) for the connected device.

- 2** When switching between the sub-screen and the main screen (large screen), press and hold down the **P-in-P** button (for 3 seconds) until the screen changes.

- 3** To close the sub-screen, press the **P-in-P** button again.

The projected image is switched.

- When the sub-screen is displayed, press the **Input** button to switch the image for the sub-screen.
- When the sub-screen is displayed, press the **Output** button to change the position and size (large or small) of the sub-screen. Each time the **Output** button is pressed, the display position moves from bottom right, top right, top left, and bottom left allowing you to change the size.

# Using the HDMI Link Function

## HDMI Link Function

When an AV device that meets the HDMI CEC standards is connected to the projector's HDMI port, you can perform linked operations such as linked power on and volume adjustment for the AV system from one remote control. Also, when projecting images in WirelessHD, you can use the HDMI link function (EH-TW6600W only).

- As long as the AV device meets the HDMI CEC standards, you can use the HDMI link function even if the AV system in-between does not meet the HDMI CEC standards.
- Up to 3 multi-media players that meet the HDMI CEC standards can be connected at the same time.

### Connection Example

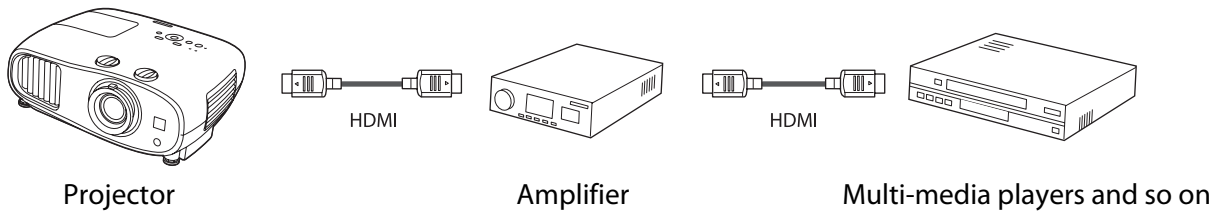

## HDMI Link Settings

By pressing the  button on the remote control, and setting **HDMI Link** to **On**, you can operate the following functions.

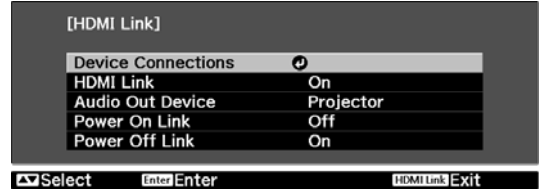

Function	Explanation
Power On Link	Powers on the projector when content is played back on the connected device. Or, powers on the connected device when the projector is turned on.
Power Off Link	Powers off the connected device when the projector is turned off. <ul style="list-style-type: none"> <li>This only works when the connected device's CEC power link function is enabled.</li> <li>Note that depending on the status of the connected device (for example, if it is recording), the device may not power off.</li> </ul>
Audio Out Device	Selects which device outputs audio. <p><b>Projector:</b> Outputs audio from the projector's built-in speakers.</p> <p><b>AV System:</b> Outputs audio from the HDMI CEC compatible AV amplifier connected to the HDMI port.</p> <p><b>WirelessHD Transmitter*</b>: Outputs audio from speakers, such as a sound bar, connected to the Optical Audio-Out port on the WirelessHD Transmitter.</p>
Input Change Link	Changes the input source of the projector to HDMI when content is played back on the connected device.
Connected Devices Operations	You can perform operations such as Play, Stop, Fast Forward, Rewind, Next Chapter, Previous Chapter, and Pause from the remote control for the projector.

\* Only EH-TW6600W is displayed.



- To use the HDMI Link function, you must configure the connected device. See the documentation supplied with the connected device for more information.
- Even when using the WirelessHD Transmitter with **Power On Link** set to **Device -> PJ** or **Bidirectional**, if **WirelessHD** is set to **On**, this projector also turns on when the AV device connected to the WirelessHD Transmitter is turned on (EH-TW6600W only).  **Settings-HDMI Link-Power On Link** [p.79](#)

## Device Connections

You can check the connected devices that are available for HDMI Link, and select on the device you want to project the image from. Devices that can be controlled by HDMI link automatically become the selected device.

1

Press the  button, and then select **Device Connections**.

The **Device Connections** list is displayed.

Devices that have an aqua icon to their left are linked.

If the device name cannot be determined this field is left blank.

2

Select the device you want to operate using the HDMI Link function.

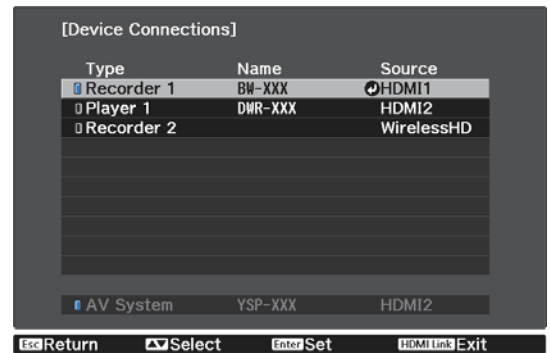

- Only one AV amplifier is recognized. If multiple amplifiers are connected, the amplifier recognized first is displayed.
- If the cable does not meet the HDMI standards, operations are not possible.
- Some connected devices or functions of those devices may not operate properly even if they meet the HDMI CEC standards. See the documentation and so on supplied with the connected device for more information.



## Playing Back Image Data (Slideshow)

### Compatible Data

The following types of files stored on USB storage devices such as USB memories, digital cameras, and so on that are connected to the projector's USB port (TypeA) can be displayed as a slideshow.

#### Slideshow compatible file types

File Type (Extension)	Notes
.jpg	<ul style="list-style-type: none"> <li>• Images using CMYK color mode are not compatible.</li> <li>• Progressive format images are not compatible.</li> <li>• Images with a resolution greater than 8192 x 8192 are not compatible.</li> <li>• Due to the characteristics of JPEG files, images may not be projected clearly if the compression ratio is too high.</li> </ul>

#### Attention

Connect a digital camera using a USB cable specified for use with the device. Do not use the USB cable supplied with your 3D Glasses.

### Playing a Slideshow

- 1 Connect a USB storage device.  
Files are displayed as thumbnails.



To open a folder, select the folder, and then press the  button.



If thumbnails of the files are not displayed, press the  button on the remote control to change the source.

- 2 Select **Slideshow**.

Use the     buttons to select **Slideshow** at the bottom right of the screen, and then press the  button.

Slideshow starts.



- To close the Slideshow, disconnect the USB storage device.
- Select an image from the thumbnails and press the button to enlarge the selected image. Press the buttons on the remote control when viewing an enlarged image to change between images. You can also rotate the image using the buttons.

## Display Settings for Image Files and Slideshow Operation Settings

You can set the file display order and slideshow operations on the option screen.

1 Use the buttons to position the cursor over the folder where you want to set display conditions, and then press the button. Select **Option** from the submenu displayed, and then press the button.

2 When the option screen is displayed, set each of the items.

Enable settings by positioning the cursor on the target item and pressing the button. The following table shows the details for each item.

Display Order	You can select to display the files in <b>Name Order</b> or <b>Date Order</b> .
Sort Order	You can select to sort the files <b>In Ascending</b> or <b>In Descending</b> order.
Continuous Play	You can set whether to repeat the play.
Screen Switching Time	When playing a slideshow, you can set the time for a single file to be displayed. You can set a time between <b>Off</b> (0) to 60 seconds. When you set <b>Off</b> , auto play is disabled.
Effect	You can set the screen effects when changing slides.

3 When you have finished making settings, use the buttons to position the cursor over **OK**, and then press the button.

The settings are applied.

If you do not want to apply the settings, position the cursor on **Cancel**, and then press the button.





# Projecting Two Different Images Using Picture in Picture

## Types of Screen that can be Displayed Simultaneously

Two different image sources can be projected, one in the main screen (large screen) and the other in the sub screen (small screen). You can view the sub screen while viewing the main screen.

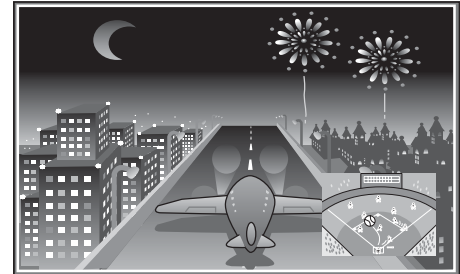

## Combinations of input sources for Picture in Picture projection

	HDMI1	HDMI2	WirelessHD*	Component	Video	PC
HDMI1	-	-	-	✓	✓	✓
HDMI2	-	-	-	✓	✓	✓
WirelessHD*	-	-	-	✓	✓	✓
Component	✓	✓	✓	-	-	-
Video	✓	✓	✓	-	-	-
PC	✓	✓	✓	-	-	-

\* EH-TW6600W only

## Projecting on a Picture in Picture

### Starting and exiting Picture in Picture

Press the **P-in-P** button on the remote control while the projector is projecting.

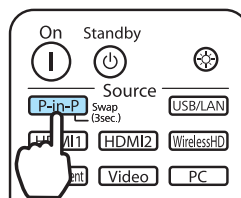

The currently input image is displayed on a Picture in Picture.

Main screen: The current image

Sub screen: The source different from the main screen

Press the **P-in-P** button again to end the Picture in Picture display.





- You cannot use Picture in Picture display to project 3D images.
- You can change the displays between the main and the sub screen by holding down the **P-in-P** button.
- If the source being input is not supported, nothing is displayed.
- The Picture in Picture function cannot be used when **Image Processing** is set to **Fast** in the **Signal** menu. **Signal-Advanced -Image Processing p.77**

■ Changing the Picture in Picture settings

Use the **Picture in Picture** menu to change the size or position of the sub screen.

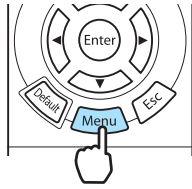
1 Press the  button.



 The **Picture in Picture** menu is displayed directly by pressing the  button during Picture in Picture projection.

2 Make settings for each of the displayed functions.

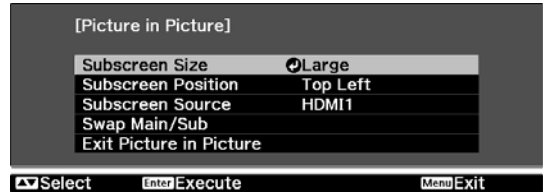

Available functions on the **Picture in Picture** menu

Function	Explanation
Subscreen Size	Selects the sub screen size using <b>Small</b> and <b>Large</b> .
Subscreen Position	Changes the sub screen position using <b>Top Right</b> , <b>Bottom Right</b> , <b>Top Left</b> , and <b>Bottom Left</b> .
Subscreen Source	Selects which source is displayed in the sub screen.
Swap Main/Sub	Changes the main and sub screens.
Exit Picture in Picture	Exits the Picture in Picture display.

# Configuration Menu Functions

## Configuration Menu Operations

On the Configuration menu, you can make adjustments and settings for Signal, Image, and so on.

1 Press the **Menu** button.

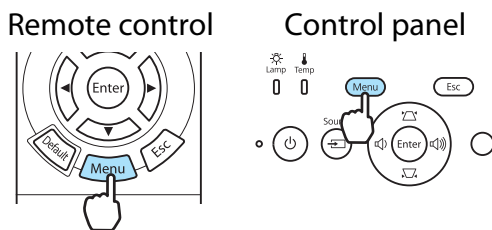

The Configuration menu is displayed.

2 Use the **Up** and **Down** buttons to select the top menu on the left, and then press the **Enter** button to confirm the selection.

When you select the top menu on the left, the sub menu on the right changes.

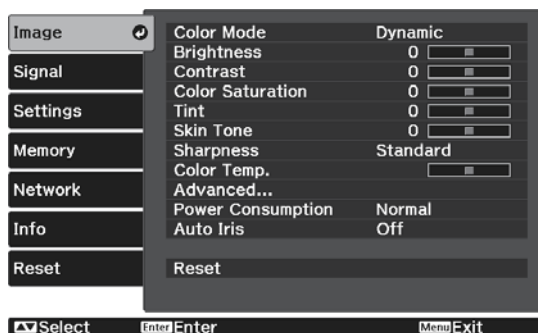

The line at the bottom is a guide for operations.

3 Use the **Up** and **Down** buttons to select the sub menu on the right, and then press the **Enter** button to confirm the selection.

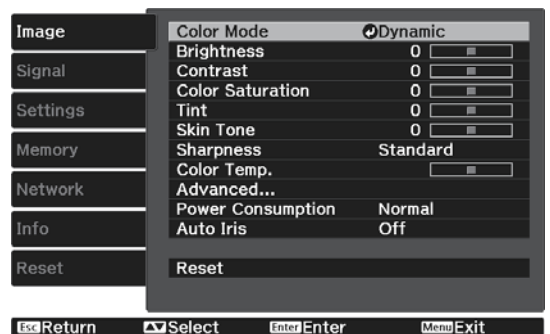

The adjustment screen for the selected function is displayed.

4 Use the **Left** and **Right** buttons to adjust the settings.

Ex.) Adjustment bar



Ex.) Choices

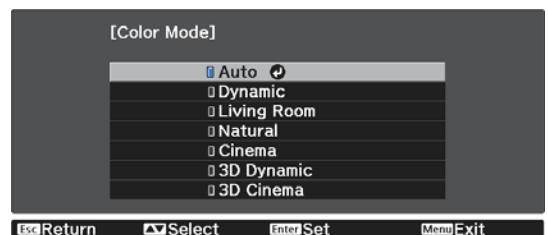

Press the **Enter** button on an item displaying this **Enter** icon to change to the selection screen for that item.

Press the **Esc** button to return to the previous level.

5 Press the **Menu** button to exit the menu.



















For items adjusted using an adjustment bar, such as the brightness level, you can press the  button while the adjustment screen is displayed to return the adjustment value to its default value.

## Configuration Menu Table

If there is no image signal being input, you cannot adjust items related to the image or signal in the Configuration menu. Note that the items displayed for the image, the signal, and other information vary depending on the image signal being projected.

### Image menu

Function	Menu/Settings		Explanation
Color Mode	Auto, Dynamic, Living Room, Natural, Cinema, 3D Dynamic, 3D Cinema		Select the image quality based on your surroundings and the image you are projecting.  <a href="#">p.32</a>
Brightness* <sup>1</sup>			Adjusts the image brightness.
Contrast* <sup>1</sup>			Adjusts the contrast between light and shade in the images. By increasing the contrast, the images become vivid.
Color Saturation* <sup>1*2</sup>			Adjusts the color saturation for the images.
Tint* <sup>1*2</sup>			Adjusts the tint for the images.
Skin Tone* <sup>1</sup>			Adjusts the skin tone. The image becomes greener when set to a positive value and redder when set to a negative value.
Sharpness	Standard		Adjusts the image sharpness.
	Advanced* <sup>2</sup>	Thin Line Enhancement, Thick Line Enhancement, Vert. Line Enhancement, Horiz. Line Enhancement 	Adjusts the image sharpness. Use this to adjust specific areas.  <a href="#">p.38</a>
Color Temp.	-3 to 6 (10 increments)* <sup>3</sup>		Adjusts the tint for the images. The image is tinted blue for high values, and tinted red for low values.

Function	Menu/Settings		Explanation	
Advanced	Gamma	2, 1, 0, -1, -2	Performs gamma adjustments. You can select a raw value or adjust the gamma while looking at the graph.  p.35	
		Customized* <sup>4</sup>		Display Confirmation Graph/Guide, Color Tone Adjustment
		Reset		
	RGB	Offset R/G/B		Adjusts the offset and gain for each R, G, and B color.  p.36
		Gain R/G/B		
RGBCMY	R/G/B/C/M/Y	Hue, Saturation, Brightness	 Adjusts the hue, saturation, and brightness for each R, G, B, C, M, and Y color.  p.35	
EPSON Super White		On, Off	(This can only be set when the <b>Color Mode</b> is set to <b>Natural</b> , <b>Cinema</b> , or <b>3D Cinema</b> and when receiving signal input from the HDMI1 or HDMI2 ports, or from WirelessHD.) Set this to <b>On</b> if you are experiencing bright over exposure of whites in your image. When set to <b>On</b> , <b>HDMI Video Range</b> settings are disabled.	
Power Consumption	High, Medium, ECO		You can set the lamp brightness to one of three settings. Select <b>ECO</b> if the images being projected are too bright. When <b>ECO</b> , power consumption during projection decreases, and fan noise is reduced.	
Auto Iris	Off, Normal, High Speed		You can set the trackability of the function to adjust the amount of light automatically in accordance with changes in brightness in the displayed image. Set to Off for no luminance adjustment.  p.39	
Reset	Yes, No		You can reset all adjustment values for <b>Image</b> to their default settings.	

\*1 When pressing the up or down button on the adjustment screen, you can move to the previous or the next adjustment menu.

\*2 This is not displayed when a computer image signal is being input.

\*3 When **Color Mode** is set to **Natural**, the settings change to **5000K - 10000K**.

\*4 Settings are saved for each type of input source or Color Mode.

■ Signal menu

Function	Menu/Settings		Explanation
3D Setup* <sup>1</sup>	3D Display	On, Off	Enables or disables the 3D image display function. 🖱️ p.46
	2D-to-3D Conversion	Off, Weak, Medium, Strong	Sets the strength of the 3D effect when converting 2D images to 3D images. 🖱️ p.52
	3D Format	Auto, Side by Side, Top and Bottom, 2D	Sets the 3D format for the input signal. When set to <b>Auto</b> , the format is recognized automatically.
	3D Depth	-10 to 10	Sets the depth for the 3D image.
	Diagonal Screen Size	60 to 300	Sets the projection size for the 3D image. By matching this to the actual size, you can achieve the optimum 3D effect.
	3D Brightness	Low, Medium, High	Sets the brightness for the 3D image.
	Inverse 3D Glasses	Yes, No	Reverses the synchronization timing for the left/right shutters on the 3D Glasses and the left/right images. Enable this function if the 3D effect is not displayed correctly.
	3D Viewing Notice	On, Off	Turns the notice that appears when viewing 3D content on or off.
Aspect* <sup>2</sup>	Auto, Normal, Full, Zoom		Selects the aspect mode. 🖱️ p.33
Tracking* <sup>2</sup> * <sup>3</sup>	Varies depending on the input signal.		Adjusts computer images when vertical stripes appear in the images.
Sync.* <sup>2</sup> * <sup>3</sup>	0 to 31		Adjusts computer images when flickering, fuzziness, or interference appear in the images. <ul style="list-style-type: none"> <li>Adjusting the <b>Brightness</b>, <b>Contrast</b>, or <b>Sharpness</b> may cause flickering or blurriness.</li> <li>Adjusting the synchronization after adjusting tracking allows for more accurate adjustments.</li> </ul>
Position* <sup>2</sup> * <sup>4</sup>			Adjusts the display position up, down, left, and right when a part of the image is missing so that the whole image is projected.
Deinterlacing* <sup>2</sup>	Off, Video, Film/Auto		(This can only be set when receiving signal input from the Video port or when receiving 480i, 576i, or 1080i signal input from the Component, HDMI1, or HDMI2 ports or from WirelessHD.) Converts the signal from interlaced (i) to progressive (p) using a method appropriate for the image signal. <ul style="list-style-type: none"> <li><b>Off</b>: This is ideal for dynamic motion images.</li> <li><b>Video</b>: This is ideal for viewing general video images.</li> <li><b>Film/Auto</b>: Performs the optimal conversion for film, CG, or animation input signals.</li> </ul>
Motion Detection* <sup>2</sup> * <sup>5</sup>	1 to 5		Sets the image motion speed from 1 (slow, for still images) to 5 (fast, for movies). Change this setting if you are experiencing poor still image quality or flickering movies.

Function	Menu/Settings		Explanation
Super-resolution* <sup>5</sup>	0 to 5		Reduces blurring that occurs at the edge of images when the resolution is increased. 🖱️ p.39
	Detail Enhancement	0 to 100	This setting enhances the contrast in an image to create the image with more emphatic texture and material feel. The higher the number is, the stronger the enhancement effect is from the outline area. 🖱️ p.39
Auto Setup* <sup>3</sup>	On, Off		Sets whether or not to automatically adjust the image whenever the input signal is changed. When enabled, the Tracking, Position, and Sync. are automatically configured.
Advanced	Noise Reduction* <sup>2</sup> * <sup>5</sup>	Off, 1, 2, 3	(This can only be set when <b>Image Processing</b> is set to <b>Fine</b> .) Smooths out rough images. There are three modes available. Select your favorite setting. It is recommended that this is set to <b>Off</b> when viewing image sources in which noise is very low, such as for DVDs.
	Setup Level* <sup>2</sup>	0%, 7.5%	(This can be set when receiving an NTSC or component video signal from the Video port.) Change this setting when using devices with a different black level (Setup Level) such as products designed for the Korean market. Check the specifications for your connected device before changing this setting.
(Advanced)	Overscan* <sup>2</sup> * <sup>5</sup>	Auto, Off, 2%, 4%, 6%, 8%	Changes the output image ratio (the range of the projected image). <ul style="list-style-type: none"><li>• <b>Off</b>, 2 to 8%: Sets the range of the image. <b>Off</b> projects all ranges. Depending on the image signal you may notice noise at the top and bottom of the image.</li><li>• <b>Auto</b>: This can only be set when receiving signal input from the HDMI1 or HDMI2 ports, or from WirelessHD. This may be automatically set to <b>Off</b> or <b>8%</b> depending on the input signal.</li></ul>
	HDMI Video Range* <sup>2</sup>	Auto, Normal, Expanded	(This can only be set when <b>EPSON Super White</b> is set to <b>Off</b> .) When set to <b>Auto</b> , the video level for the DVD input signal to the HDMI1 or HDMI2 port on the projector is automatically detected and set. If you experience under or overexposure when set to <b>Auto</b> , set the video level of the projector to match that of the DVD player's video level. Your DVD player may be set to Normal or Expand. The <b>Auto</b> option is not displayed when connected to a connected device's DVI port.
	Image Processing* <sup>5</sup>	Fine, Fast	Performs processing to improve the image quality or response speed. 🖱️ p.41

Function	Menu/Settings	Explanation
Reset	Yes, No	Resets all <b>Signal</b> settings except for <b>Diagonal Screen Size, 3D Viewing Notice, Aspect, and Image Processing</b> settings to their default settings.

\*1 This is only displayed when an HDMI1, HDMI2, or WirelessHD image signal is being input. (WirelessHD is for EH-TW6600W only.)



\*2 Settings are saved for each type of input source or signal.

\*3 This is only displayed when a PC image signal is being input.









\*4 This is only displayed when a Component, PC, or Video image signal is being input.

\*5 This is only displayed when a Component, HDMI1, HDMI2, Video, or WirelessHD image signal is being input (WirelessHD is for EH-TW6600W only).



## Settings menu



Function	Menu/Settings		Explanation
H/V-Keystone	V-Keystone	-60 to 60	Performs vertical keystone correction.  <a href="#">p.30</a>
	H-Keystone	-60 to 60	Performs horizontal keystone correction.  <a href="#">p.30</a>
Audio	Volume	Volume    0 to 40	Adjusts the volume.
	Inverse Audio	On, Off	Sets whether or not to invert the left and right audio output channels. Set to <b>On</b> when the projector is suspended from a ceiling and is using the internal speakers.
HDMI Link	Device Connections	-	Displays a list of devices connected from the HDMI1 or HDMI2 ports, or from WirelessHD*.
	HDMI Link	On, Off	Enables or disables the HDMI Link function.
	Audio Out Device	Projector, AV System, WirelessHD Transmitter*	Sets which device outputs audio when using the HDMI Link function.  <a href="#">p.68</a>
	Power On Link	Off, Bidirectional, Device -> PJ, PJ -> Device	Sets the link function when the power is turned on. Set to power on the projector when content is played on a connected device (Bidirectional or Device -> PJ) or to power on a connected device when the projector is turned on (Bidirectional or PJ -> Device).
	Power Off Link	On, Off	Sets whether or not to power off connected devices when the projector is turned off.



Function	Menu/Settings		Explanation
WirelessHD*	Device Connections	-	Displays a list of available WirelessHD devices that can be connected.
	WirelessHD	On, Off	Enables or disables the WirelessHD function.
	Video Reception		Video Reception indicates the connection status with the WirelessHD Transmitter. When the projector is connected to the WirelessHD Transmitter and receives an image signal, Transmitter detected appears.
	WiHD Mode	Full, Dynamic	Sets the connection mode of WirelessHD devices.
	Reset	Yes, No	Resets <b>WirelessHD</b> settings to their default settings. Note that even if you reset the projector, the WirelessHD Transmitter settings are not reset. To reset the WirelessHD Transmitter, press the Setup button on the base for 5 seconds or more.  <a href="#">p.54</a>
Lock Setting	Child Lock	On, Off	This locks the  button on the projector's control panel to prevent children from turning on the projector by accident. You can turn on the power when locked by holding down the  button for approximately three seconds. You can still turn off the device using the  button, or perform operations with the remote control as usual. If changed, this setting is enabled after you power off the projector and the cool-down process is complete. Note that even if <b>Child Lock</b> is set to <b>On</b> , the projector still turns on when the power cord is connected if <b>Direct Power On</b> is set to <b>On</b> .
	Control Panel Lock	On, Off	When set to <b>On</b> , all buttons on the control panel except for the  button are disabled.  is displayed on the screen if any buttons are pressed. To unlock, press and hold the  button on the control panel for at least 7 seconds. If changed, this setting is enabled once you close the Configuration menu.

Function	Menu/Settings	Explanation
Projection	Front, Front/Ceiling, Rear, Rear/Ceiling	<p>Change this setting depending on how the projector is installed.</p> <ul style="list-style-type: none"> <li>• <b>Front:</b> Select if you are projecting in front of the screen.</li> <li>• <b>Front/Ceiling:</b> Select if you are projecting in front of the screen suspended from the ceiling.</li> <li>• <b>Rear:</b> Select if you are projecting to a rear screen from the back.</li> <li>• <b>Rear/Ceiling:</b> Select if you are projecting to a rear screen from the back when the projector is suspended from the ceiling.</li> </ul>
User Button	2D-to-3D Conversion, Power Consumption, Info	<p>Select a Configuration menu item to assign to the <input type="button" value="User"/> button on the remote control. By pressing the button, the assigned menu item selection/adjustment screen is displayed, allowing you to make one-touch settings/adjustments.</p>
Picture in Picture	-	<p>Starts the Picture in Picture display.</p> <p> <a href="#">p.72</a></p>

Function	Menu/Settings		Explanation
Operation	Direct Power On	On, Off	You can set up the projector so that projection starts as soon as the power cord is plugged in without any button operations. Note that when this is set to <b>On</b> , projection starts if power is restored after a blackout or other power outage and the power cord is still plugged into the projector.
	Sleep Mode	Off, 5min., 10min., 20min.	If the set time is exceeded and no signal is input, the projector is automatically turned off and enters standby mode. When set to <b>Off</b> , the projector never enters sleep mode. When in standby mode, press the  button on the remote control or the  button on the control panel to start projection.
	Illumination	On, Off	Set this to <b>Off</b> if the light from the indicators on the control panel bothers you when watching a movie in a dark room.
	Trigger Out	On, Off	Set the Trigger Out function to communicate the projector's power on status and so on to external devices. When set to <b>Off</b> , no voltage is output from the Trigger Out port. When set to <b>On</b> , voltage is output from the Trigger Out port when the projector is on. If you change this setting, the new setting will take effect the next time you turn the projector on.
	High Altitude Mode	On, Off	Set this to <b>On</b> if you are using the projector above an altitude of 1500 meters.

Function	Menu/Settings		Explanation
Display	Messages	On, Off	<p>Sets whether or not to display the following messages (On or Off).</p> <ul style="list-style-type: none"> <li>Item names for image signals, color modes, aspect ratios, and loading memory.</li> <li>If the internal temperature is rising when no image signal is being input or an unsupported signal is detected.</li> </ul>
	Display Background	Black, Blue, Logo	Selects the screen status when no image signal is being input.
	Startup Screen	On, Off	<p>Sets whether or not to show a start-up screen when projection begins (On or Off). If changed, this setting is enabled after you power off the projector and the cool-down process is complete.</p>
	Standby Confirmation	On, Off	<p>Sets whether or not to display a standby confirmation message (On or Off).  <a href="#">p.25</a></p>
Panel Alignment	Panel Alignment	On, Off	Enables or disables <b>Panel Alignment</b> .
	Select Color	R, B	Select the color to correct.
	Pattern Color	R/G/B, R/G, G/B	Select the pattern used for correction.
	Start Adjustments	-	Starts <b>Panel Alignment</b> .  <a href="#">p.40</a>
	Reset	Yes, No	Resets the correction value.
Language	-		Selects the display language.
Reset	Yes, No		<p>All adjustment values for <b>Settings</b> are returned to their default settings, except for the following.</p> <ul style="list-style-type: none"> <li><b>Inverse Audio</b></li> <li><b>Audio Out Device</b></li> <li><b>Power On Link</b></li> <li><b>Power Off Link</b></li> <li><b>Projection</b></li> <li><b>User Button</b></li> <li><b>High Altitude Mode</b></li> <li><b>Language</b></li> </ul>

\* Only EH-TW6600W is displayed.

Memory menu

Function	Explanation
Load Memory	Loads settings saved using the <b>Save Memory</b> function.  p.44 This cannot be selected if you have not saved any settings with the <b>Save Memory</b> function.
Save Memory	Saves certain <b>Image</b> and <b>Signal</b> settings to memory.  p.43
Erase Memory	Erases settings saved to memory that you no longer need.  p.44
Rename Memory	Renames a saved memory.  p.44

Network menu

Function	Explanation
Net. Info. - Wireless LAN	Displays the following network setting status information. <ul style="list-style-type: none"> <li>• Connection Mode</li> <li>• Wireless LAN system</li> <li>• Antenna Level</li> <li>• Projector Name</li> <li>• SSID</li> <li>• DHCP</li> <li>• IP Address</li> <li>• Subnet Mask</li> <li>• Gateway Address</li> <li>• MAC Address</li> <li>• Region Code*</li> </ul>
Network Configuration	Takes you to the network configuration menu.  p.85

\* This displays the available region information on your Wireless LAN unit. For more details, contact us at the following address. [Epson Projector Contact List](#)

Notes on Network menu operations

When you select the Network menu, the menu tabs are changed.

The basic operations are the same as those for the Configuration menu.

However, when exiting the menu, be sure to select the **Setup complete** and then save the settings.

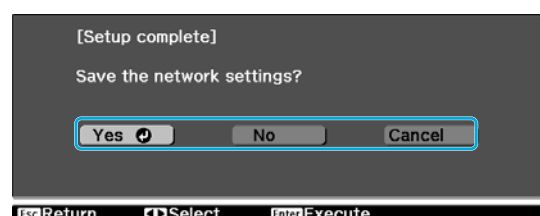
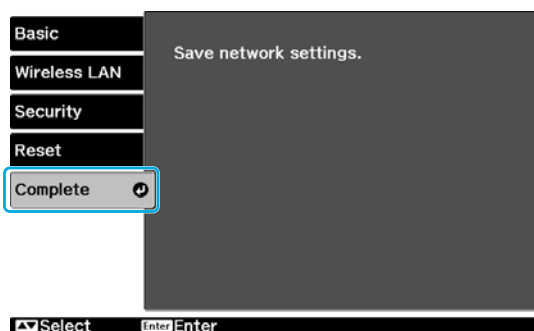

- Yes:** Saves the settings and exits the Network menu.
- No:** Does not save the settings and exits the Network menu.
- Cancel:** Continues the Network menu.

### Soft keyboard operations

The Network menu displays a soft keyboard when input of alphanumerics is required during setup. Press the buttons on the remote control or the buttons on the control panel to select keys, and then press the button to input them. Selecting **Finish** confirms your input, and selecting **Cancel** cancels your input.

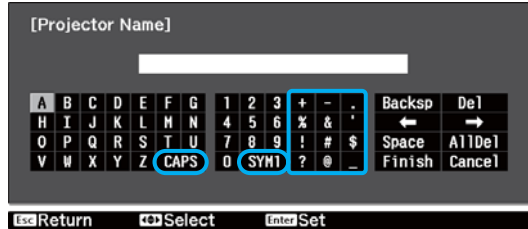

- CAPS** key: Sets and changes between upper case and lower case letters.
- SYM1/2** key: Sets and changes the symbol keys.

### Basic menu

Function	Explanation
Projector Name	Displays the unique name used to identify this projector on a network. When editing, you can enter up to 16 single-byte alphanumeric characters.

### Wireless LAN

Function	Menu/Settings	Explanation
Wireless LAN Power	On, Off	Set whether or not (On/Off) to use a wireless LAN. Selecting <b>Off</b> can prevent unauthorized access from outsiders.
Connection Mode	Quick, Advanced	Sets a wireless LAN connection mode. <b>Quick:</b> The projector provides an access point. Connect a computer or a smartphone directly to the projector. <b>Advanced:</b> When having already established a wireless LAN environment, connect the projector to the existing access point.
Channel	1ch, 6ch, 11ch	(This can only be set when <b>Connection Mode</b> is set to <b>Quick</b> .) Select the frequency band used for a wireless LAN.
SSID	-	(This can only be set when <b>Connection Mode</b> is set to <b>Advanced</b> .) Enter an SSID. When an SSID is specified in the wireless LAN system where the projector participates, enter that SSID. You can enter up to 32 single-byte alphanumeric characters.
Search Access Point	-	(This can only be set when <b>Connection Mode</b> is set to <b>Advanced</b> .) indicates the current access point.  indicates the access point where security is ensured. When selecting the access point where security is ensured, you will be taken to the Security menu. <a href="#">p.86</a>

Function	Menu/Settings	Explanation
IP Settings (This can only be set when <b>Connection Mode</b> is set to <b>Advanced</b> .)	DHCP	Set whether or not (On/Off) to use DHCP. If specifying the following address, set it to <b>Off</b> .
	IP Address	Enter the projector's IP address. The following IP addresses cannot be used. 0.0.0.0, 127.x.x.x, 224.0.0.0 to 255.255.255.255 (where x is a number from 0 to 255)
	Subnet Mask	Enter the projector's subnet mask. The following subnet masks cannot be used. 0.0.0.0, 255.255.255.255
	Gateway Address	Enter the projector's gateway IP address. The following gateway addresses cannot be used. 0.0.0.0, 127.x.x.x, 224.0.0.0 to 255.255.255.255 (where x is a number from 0 to 255)
SSID Display	On, Off	Set whether or not (On/Off) to display the SSID onto the LAN standby screen.
IP Address Display	On, Off	Set whether or not (On/Off) to display the IP address onto the LAN standby screen.

Security menu

Function	Menu/Settings	Explanation
Security	Off, WPA2-PSK, WPA/WPA2-PSK	Set a security system. In <b>Quick</b> , <b>WPA2-PSK</b> is selectable. In <b>Advanced</b> , <b>WPA2-PSK/WPA/WPA2-PSK</b> is selectable.
Passphrase	-	Enter a passphrase. The passphrase accepts 8 up to 32 single-byte alphanumeric characters, and is case-sensitive. In order to ensure security, it is recommended that you change it periodically.

Reset menu

Function	Explanation
Reset network settings.	Resets all adjustment values for <b>Network</b> to their default settings.

☐ Info menu

Function	Menu/Settings	Explanation
Projector Info	Lamp Hours	Displays the cumulative lamp operating time.
	Source	Displays the source name for the connected equipment currently being projected.
	Input Signal	Displays the input signal.
	Resolution	Displays the resolution.
	Scan Mode	Displays the scan mode.
	Refresh Rate	Displays the refresh rate.
	3D Format	Displays the 3D format of the signal input during 3D projection (Frame Packing, Side by Side, or Top and Bottom).
	Sync Info	Displays the image signal information. This information may be needed if service is required.
	Deep Color	Displays Deep Color.
	Video Signal	Displays the signal type of the video device connected to the Video port.
	Status	This is information about errors that have occurred on the projector. This information may be needed if service is required.
	Serial Number	Displays the projector's serial number.
	Event ID	Displays the application error log. 🖱️ <a href="#">p.101</a>
Version	Main	Displays the firmware version of the projector.
	Video	
	Video2	





☐ Reset menu

Function	Explanation
Reset All	Resets all items in the Configuration menu to their default settings. The following items are not reset to their defaults: <b>Panel Alignment, Lamp Hours, Language, Network, Memory.</b>
Reset Memory	Erases all settings saved using the <b>Save Memory</b> function.
Reset Lamp Hours	Resets the cumulative lamp hours use time to <b>0 H</b> . Reset when you replace the lamp.



Picture in Picture menu





Displayed by pressing the  button during Picture in Picture projection.

Function	Menu/Settings		Explanation
Picture in Picture	Subscreen Size	Small, Large	Changes the size of the sub screen.  <a href="#">p.73</a>
	Subscreen Position	Top Right/Bottom Right/Top Left/Bottom Left	Changes the position of the sub screen.
	Subscreen Source	HDMI1, HDMI2, WirelessHD*, Component, Video, PC	Selects which source is displayed as the sub screen.  <a href="#">p.73</a>
	Swap Main/Sub		Changes the main and sub screens.  <a href="#">p.73</a>
	Exit Picture in Picture		Exits the Picture in Picture display.  <a href="#">p.73</a>

\* Only EH-TW6600W is displayed.

# Problem Solving



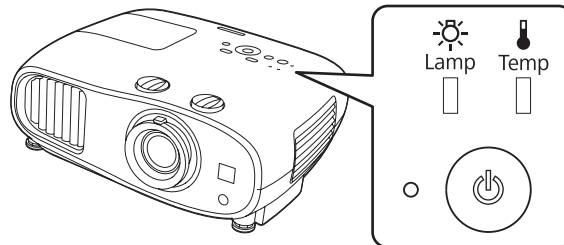

## Reading the Indicators













You can check the status of the projector from the flashing and lit ,  (operation indicators),  and  on the control panel.











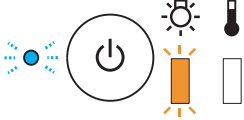

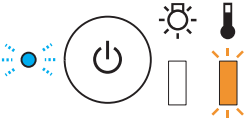
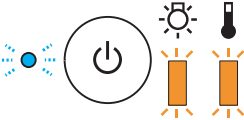
Refer to the following table to check the projector's status and how to remedy problems shown by the indicators.

### Indicator status during an error/warning

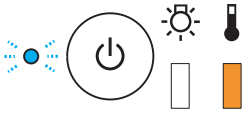





 : Lit  : Flashing  : Status maintained  : Off

Indicators	Status	Remedy
     (blue)/(orange)	Replace Lamp	It is time to replace your lamp. Replace the lamp with a new lamp as soon as possible.  <a href="#">p.106</a> The lamp may explode if you continue to use it in this status.
     (blue)/(orange)	High Temp Warning	You can continue projecting. If the temperature rises too high again, projection stops automatically. <ul style="list-style-type: none"> <li>• If the projector is installed next to a wall, make sure there is at least 20 cm between the wall and the projector's exhaust vent.</li> <li>• If the air filter is clogged, clean it.  <a href="#">p.102</a></li> </ul>

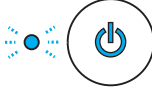

Indicators	Status	Remedy
 <p>(blue)/(orange)</p>	<p>Internal Error</p>	<p>The projector has malfunctioned. Remove the power plug from the electrical outlet, and contact your local dealer or the nearest Epson repair center.  <a href="#">Epson Projector Contact List</a></p>
 <p>(blue)/(orange)</p>	<p>Fan Error Sensor Error</p>	
 <p>(blue)/(orange)</p>	<p>Auto Iris Error</p>	
 <p>(blue)/(orange)</p>	<p>Power Err. (Ballast)</p>	
 <p>(blue)/(orange)</p>	<p>Lamp Error Lamp Failure</p>	<p>There is a problem with the lamp, or it failed to turn on.</p> <ul style="list-style-type: none"> <li>• Disconnect the power cord, and then check if the lamp is cracked.  <a href="#">p.106</a> If it is not cracked, reinstall the lamp and turn on the power. If reinstalling the lamp does not fix the problem, or if the lamp is cracked, remove the power plug from the electrical outlet, and contact your local dealer or the nearest Epson repair center.  <a href="#">Epson Projector Contact List</a></li> <li>• Check that the lamp cover has been properly closed.</li> </ul>
 <p>(blue)/(orange)</p>	<p>High Temp Error (Overheating)</p>	<p>The internal temperature is too high.</p> <ul style="list-style-type: none"> <li>• The lamp turns off automatically and projection stops. Wait for about five minutes. When the fan has stopped, disconnect the power cord.</li> <li>• If the projector is installed next to a wall, make sure there is at least 20 cm between the wall and the projector's exhaust vent.</li> <li>• If the air filter is clogged, clean it.  <a href="#">p.102</a></li> <li>• If turning the power back on does not clear the problem, stop using the projector and remove the power plug from the electrical outlet. Contact your local dealer or the nearest Epson repair center.  <a href="#">Epson Projector Contact List</a></li> <li>• When using at an altitude of 1500 m or more, set <b>High Altitude Mode</b> to <b>On</b>.  <a href="#">Settings - Operation - High Altitude Mode</a> <a href="#">p.79</a></li> </ul>

Indicator status during normal operation

 : Lit  : Flashing  : Off

Indicators	Status	Remedy
	Standby condition	When you press the  button on the remote control, or the  button on the control panel, projection starts after a short wait.
 (blue)	Warm-up in progress	Warm-up time is about 30 seconds. The power-off operation is disabled while the projector is warming-up.
	Cool-down in progress	All operations are disabled while the projector is cooling-down. The projector enters standby condition when cool-down is complete. If for any reason the power cord is disconnected during cool-down, wait until the lamp has cooled down sufficiently (about 10 minutes), reconnect the power cord, and then press the  button on the remote control, or the  button on the control panel.
 (blue)	Projection in progress	The projector is operating normally.



- Under normal operating conditions, the  and  indicators are off.
- When the **Illumination** function is set to **Off**, all indicators are off under normal projection conditions.  
 **Settings - Operation - Illumination** [p.79](#)

## When the Indicators Provide No Help

### ■ Check the problem





Check the following table to see if your problem is mentioned, and go to the appropriate page for information on handling the problem.

	Problem	Page
Problems relating to images	No images appear	<a href="#">p.93</a>
	Projection does not start, the projection area is completely black, or the projection area is completely blue.	
	Moving images being projected from a computer are not projected	<a href="#">p.93</a>
	" <b>Not supported</b> " is displayed	<a href="#">p.93</a>
	" <b>No Signal</b> " is displayed	<a href="#">p.94</a>
	Images are fuzzy or out of focus	<a href="#">p.94</a>
	Interference or distortion appears in the images	<a href="#">p.94</a>
	The image is truncated (large) or small, or only a part of the image is projected	<a href="#">p.95</a>
	Image colors are not right	<a href="#">p.95</a>
	The whole image appears purplish or greenish, images are black & white, or colors appear dull.*	
	Images appear dark	<a href="#">p.95</a>
Projection stops automatically	<a href="#">p.96</a>	
Problems when projection starts	The projector does not turn on	<a href="#">p.96</a>
Problems with the remote control	The remote control does not respond	<a href="#">p.96</a>
Problems with the control panel	Cannot make settings on the control panel	<a href="#">p.97</a>
Problems with 3D	Cannot project correctly in 3D	<a href="#">p.97</a>
	The 3D image is enlarged and truncated	<a href="#">p.98</a>
Problems with HDMI	HDMI Link does not function	<a href="#">p.98</a>
	The device name is not displayed under device connections	<a href="#">p.98</a>
Problems with WirelessHD	Cannot project WirelessHD images	<a href="#">p.98</a>
	WirelessHD audio is not output correctly	<a href="#">p.99</a>
	Interference, distortion, or interruption appear in WirelessHD	<a href="#">p.99</a>
Problems with USB storage devices	Slideshow does not start	<a href="#">p.100</a>
Other problems	No audio, or the audio is too low	<a href="#">p.100</a>
	A network cannot be connected via a wireless LAN	<a href="#">p.100</a>

\* Because color reproduction differs between monitors and computer LCD screens, the image projected by the projector and the color tones displayed on the monitor may not match, however this is not a fault.

■ Problems relating to images

No images appear

Check	Remedy
Is the projector turned on?	Press the  button on the remote control or the  button on the control panel.
Is the power cord connected?	Connect the power cord.
Are the indicators switched off?	Disconnect and then reconnect the projector's power cord. Check that pressing the power button after connection supplies the projector with power.
Is an image signal being input?	Check that the connected device is turned on. When <b>Messages</b> is set to <b>On</b> from the Configuration menu, image signal messages are displayed.  <b>Settings - Display - Messages</b> p.79
Has the power to the AV amplifier been disconnected?	If an AV amplifier is connected, check the AV amplifier's power supply.
Is an image signal being sent from the device?	Check that an image signal is being sent from the connected device.
Are the Configuration menu settings correct?	Reset all of the settings.  <b>Reset - Reset All</b> p.87
(Only when projecting computer image signals) Was the connection made while the power of the projector or the computer was already turned on?	If the connection is made while the power is already turned on, the key (Function key and so on) that changes the computer's image signal to external output may not work. Turn off the connected computer, and then turn it back on.



Moving images are not displayed

Check	Remedy
(Only when projecting computer image signals) Is the computer's image signal set to external output and to output to the LCD monitor at the same time?	Depending on the computer's specifications, moving images may not be displayed when the computer is set to external output and to the LCD monitor output at the same time. Change it so that the image signal is set to external output only. For the computer's specifications, see the documentation supplied with the computer.

"Not supported" is displayed.

Check	Remedy
(Only when projecting computer image signals) Do the image signal's frequency and resolution correspond to the mode?	Check the image signal being input in <b>Resolution</b> from the Configuration menu, and check that it corresponds to the projector's resolution.  p.110



**"No Signal"** is displayed.

Check	Remedy
Are the cables connected correctly?	Check that all the cables required for projection are securely connected.  <a href="#">p.18</a>
Is the correct image input port selected?	Change the image with the source buttons on the remote control, or the  button on the control panel.  <a href="#">p.25</a>
Is the connected device turned on?	Turn on the device.
(Only when projecting computer image signals) Are the image signals being output to the projector?	Change it so that the image signal is set to external output, and not just the computer's LCD monitor. For some models, when the image signals are output externally, they no longer appear on the LCD monitor. For the computer's specifications, see the documentation supplied with the computer.  If the connection is made while the power of the projector or the computer is already turned on, the Fn key (Function key) that changes the computer's image signal to external output may not work. Turn off the computer and the projector, and then turn them back on.

Keystone distortion of projected image



Check	Remedy
Is keystone distortion adjusted within the correction range?	If projecting the image from outside of the correctable range, you may not be able to correct the keystone distortion completely. Install the projector horizontally in front of the screen as far as possible, and then adjust the projection position using lens shift.  <a href="#">p.13</a>

Images are fuzzy or out of focus

Check	Remedy
Has the focus been adjusted?	Adjust the focus.  <a href="#">p.27</a>
Is the lens cap attached?	Remove the lens cap.
Is the projector at the correct distance?	Check the recommended projection range.  <a href="#">p.15</a>
Has condensation formed on the lens?	If the projector is suddenly taken from a cold environment to a warm environment, or if sudden ambient temperature changes occur, condensation may form on the surface of the lens, and this may cause the images to appear fuzzy. Set the projector up in the room about one hour before it is used. If the projector is wet from condensation, turn off the projector, disconnect the power cord, and leave it for a while.

Interference or distortion appear in images

Check	Remedy
Are the cables connected correctly?	Check that all the cables required for projection are securely connected.  <a href="#">p.18</a>

Check	Remedy
Is an extension cable being used?	If an extension cable is used, electrical interference may affect the signals.
(Only when projecting computer image signals) Are the <b>Sync.</b> and <b>Tracking</b> settings adjusted correctly?	The projector uses automatic adjustment functions to project at the optimum status. However, depending on the signal, some may not be adjusted correctly even after performing self corrections. If this happens, adjust the <b>Tracking</b> and <b>Sync.</b> settings from the Configuration menu.  <b>Signal - Tracking/Sync.</b> p.77
(Only when projecting computer image signals) Is the correct resolution selected?	Set the computer so that the signals being output are compatible with the projector.  p.110

Part of the image is truncated (large) or small











Check	Remedy
Is the correct <b>Aspect</b> selected?	Press the <input type="button" value="Aspect"/> button, and then select the <b>Aspect</b> that matches the input signal.  <b>Signal - Aspect</b> p.77
Is the image <b>Position</b> adjusted correctly?	Adjust the <b>Position</b> setting from the Configuration menu.  <b>Signal - Position</b> p.77
(Only when projecting computer image signals) Is the correct resolution selected?	Set the computer so that the signals being output are compatible with the projector.  p.110

Image colors are not right

Check	Remedy
Are the cables connected correctly?	Check that all the cables required for projection are securely connected.  p.18 For the Video and Component ports, make sure the connector is the same color as the cable port.  p.18
Is the contrast adjusted correctly?	Adjust the <b>Contrast</b> setting from the Configuration menu.  <b>Image - Contrast</b> p.75
Is the color adjusted correctly?	Adjust the <b>Advanced</b> setting from the Configuration menu.  <b>Image - Advanced</b> p.75
(Only when projecting images from a video device) Are the color saturation and tint adjusted correctly?	Adjust the <b>Color Saturation</b> and <b>Tint</b> settings from the Configuration menu.  p.75



Images appear dark

Check	Remedy
Is the image brightness set correctly?	Adjust the <b>Brightness</b> setting from the Configuration menu.  <b>Image - Brightness</b> p.75
Is the contrast adjusted correctly?	Adjust the <b>Contrast</b> setting from the Configuration menu.  <b>Image - Contrast</b> p.75







Check	Remedy
Is it time to replace the lamp?	When the lamp is nearly ready for replacement, the images become darker and the color quality becomes poorer. When this happens, replace the lamp with a new lamp.  <a href="#">p.106</a>

### Projection stops automatically

Check	Remedy
Is <b>Sleep Mode</b> enabled?	If the set time is exceeded and no signal is input, the lamp turns off automatically, and the projector enters standby status. The projector returns from standby status when you press the  button on the remote control or the  button on the control panel. If you do not want to use <b>Sleep Mode</b> , change the setting to <b>Off</b> .  <b>Settings - Operation - Sleep Mode</b> <a href="#">p.79</a>



### Problems when projection starts

#### The projector does not turn on

Check	Remedy
Is the power turned on?	Press the  button on the remote control or the  button on the control panel.
Is <b>Child Lock</b> set to <b>On</b> ?	When <b>Child Lock</b> is set to <b>On</b> from the Configuration menu, hold down the  button on the control panel for approximately three seconds, or perform operations from the remote control.  <b>Settings - Lock Setting - Child Lock</b> <a href="#">p.79</a>
Do the indicators turn on and off when the power cord is touched?	Turn off the projector, and then disconnect and reconnect the projector's power cord. If the problem continues, stop using the projector, remove the power plug from the electrical outlet, and contact your local dealer or the nearest projector information center.  <a href="#">Epson Projector Contact List</a>

### Problems with the remote control

#### The remote control does not respond

Check	Remedy
Is the remote control light-emitting area pointing towards the remote receiver on the projector during operation?	Point the remote control towards the remote receiver. Also, check the operating range.  <a href="#">p.23</a>
Is the remote control too far from the projector?	Check the operating range.  <a href="#">p.23</a>
Is direct sunlight or strong light from fluorescent lamps shining onto the remote receiver?	Set the projector up in a location where strong light does not shine onto the remote receiver.
Are the batteries dead or have the batteries been inserted correctly?	Make sure the batteries are inserted correctly or replace the batteries with new ones if necessary.  <a href="#">p.23</a>

Check	Remedy
Is the remote control pointed at the WirelessHD Transmitter when operating the WiHD Transmitter control button? (EH-TW6600W only)	Make sure you point the remote control at the WirelessHD Transmitter when using the WiHD Transmitter control button on the remote control. 🖱️ <a href="#">p.62</a>

▣ Problems with the control panel

Cannot make settings on the control panel

Check	Remedy
Is <b>Control Panel Lock</b> set to <b>On</b> ?	If <b>Control Panel Lock</b> is set to <b>On</b> from the Configuration menu, all of the control panel buttons except for ⏻ button are disabled. Perform operations from the remote control. 🖱️ <b>Settings - Lock Setting - Control Panel Lock</b> <a href="#">p.79</a>

▣ Problems with 3D

Cannot project correctly in 3D



Check	Remedy
Are the 3D Glasses turned on?	Turn on the 3D Glasses.
Is a 3D image being projected?	If the projector is projecting a 2D image, or if an error occurs on the projector that prevents the 3D image from being projected, you cannot view 3D images even if you are wearing the 3D Glasses.
Is the input image in 3D?	Check that the input image is 3D compatible. Since most TV broadcasts do not contain a 3D format signal, 3D reception must be set manually.
Is <b>3D Display</b> set to <b>Off</b> ?	If <b>3D Display</b> is set to <b>Off</b> from the Configuration menu, the projector does not automatically change to 3D even when a 3D image is input. Press the  button. 🖱️ <b>Signal - 3D Setup - 3D Display</b> <a href="#">p.77</a>
Is the correct 3D format set?	The projector automatically selects the appropriate 3D format, but if the 3D image is not displayed correctly, use <b>3D Format</b> from the Configuration menu to select another format. 🖱️ <b>Signal - 3D Setup - 3D Format</b> <a href="#">p.77</a>
Are you viewing within the reception range?	Check the range within which the 3D Glasses can communicate with the projector, and view within that range. 🖱️ <a href="#">p.49</a>
Has pairing been performed correctly?	See the User's Guide for the 3D Glasses to perform pairing.
Are there any devices that cause radio wave interference in the vicinity?	When using other devices at the same time with the frequency band (2.4 GHz) such as Bluetooth communication devices, wireless LAN (IEEE802.11b/g), or microwave ovens, radio wave interference may occur, the image may be interrupted, or communication may not be possible. Do not use the projector near these devices.

The 3D image is enlarged and truncated

Check	Remedy
Is the correct 3D video format set?	Video may be truncated if an incorrect 3D format is set. Set the correct 3D format.  <a href="#">p.46</a>

 Problems with HDMI

HDMI link does not function

Check	Remedy
Are you using a cable that meets the HDMI standards?	Operations are not possible with cables that do not meet the HDMI standards.
Does the connected device meet the HDMI CEC standards?	If the connected device does not meet the HDMI CEC standards, it cannot be operated even if it is connected to the HDMI port. See the documentation and so on supplied with the connected device for more information. Also, press the  button, and then check if the device is available under <b>Device Connections</b> .  <a href="#">p.69</a>
Are the cables connected correctly?	Check that all the cables required to use HDMI Link are securely connected.  <a href="#">p.68</a>
Is the power for the amplifier or DVD recorder and so on turned on?	Put each device in standby status. See the documentation and so on supplied with the connected device for more information. If you have connected a speaker and so on, set the connected device to PCM output.
Was a new device connected, or was the connection changed?	If the CEC function for a connected device needs to be set again, for example when a new device is connected or the connection is changed, you may need to restart the device.
Are too many multi-media players connected?	Up to 3 multi-media players that meet the HDMI CEC standards can be connected at the same time.





The device name is not displayed under Device Connections

Check	Remedy
Does the connected device meet the HDMI CEC standards?	If the connected device does not meet the HDMI CEC standards, it is not displayed. See the documentation and so on supplied with the connected device for more information.

 Problems with WirelessHD (EH-TW6600W only)

Cannot project WirelessHD images

Check	Remedy
Does the cable connecting the supplied WirelessHD Transmitter meet the HDMI standards?	If the cable does not meet the HDMI standards, operations are not possible.



Check	Remedy
Is <b>WirelessHD</b> set to <b>Off</b> ?	When <b>WirelessHD</b> is set to <b>Off</b> from the Configuration menu, projection is not possible for WirelessHD input signals. Set <b>WirelessHD</b> to <b>On</b> , and then press the  button. <b>Settings - WirelessHD</b> p.79
Are signals being received within the WirelessHD transmission range?	Check the range within which the WirelessHD's transceiver can communicate, and view within that range.  p.61
Is the supplied WirelessHD Transmitter turned on?	Check the power lamp on the WirelessHD Transmitter. If there is no power being supplied, make sure the connector for the AC adapter is securely connected, and then turn on the power switch.
Is the WirelessHD indicator for the supplied WirelessHD Transmitter off?	No signal is output from the AV device connected to the WirelessHD Transmitter. Check that the cables from the AV device and the WirelessHD Transmitter are securely connected.  When you last viewed the images that had been output to a monitor device, such as television, via the Output port, the images will be projected on the same monitor device as the last one the next time the projector is turned on. To cancel the setting, press the  button (switch output) on the remote control while pointing it at the WirelessHD Transmitter.  p.63
Is the Link indicator for the supplied WirelessHD Transmitter off?	The WirelessHD cannot communicate with the projector. Check the range within which the WirelessHD's transceiver can communicate, and setup within that range.
Has dust collected in the WirelessHD Transmitter's vent?	Has dust collected in the WirelessHD Transmitter's vent? Communication may not be possible if dust has collected in the vent. Install the projector so that dust does not collect in the vent.
Are the projector and the WirelessHD Transmitter facing the correct way?	Setup the projector and the WirelessHD Transmitter so that they are facing each other.
Is " <b>Source: WirelessHD X</b> "/" <b>No Signal</b> " displayed in the lower-left part of the screen?	Check that the AV device connected with the HDMI port on the WirelessHD Transmitter is turned on. The input signal number displayed on the screen is the same as the HDMI port number. In addition, unless <b>HDMI Link</b> is set to <b>On</b> , the connected device does not turn on. Set <b>HDMI Link</b> to <b>On</b> .  <b>Settings - HDMI Link - HDMI Link</b> p.79

WirelessHD audio is not output correctly.

Check	Remedy
Is audio output when the WirelessHD is connected?	When connecting a device, such as a sound bar, to the Optical Audio-Out port on the WirelessHD Transmitter to output audio from there, set <b>Audio Out Device</b> to <b>WirelessHD Transmitter</b> . The connected sound bar must be set to surround sound. To output audio from the projector, set it to <b>Projector</b> .  <b>Settings - HDMI Link - Audio Out Device</b> p.79

Interference, distortion, or interruption appear in WirelessHD

Check	Remedy
Are signals being received within the WirelessHD transmission range?	Check the range within which the WirelessHD's transceiver can communicate, and view within that range.  p.61

Check	Remedy
Are there any obstructions between the WirelessHD Transmitter and the projector?	Because WirelessHD communicates using a tight beamed electromagnetic wave, if there are any people or objects and so on obstructing the communication path, this could have an adverse affect on the image. Make sure that there are no obstacles between the WirelessHD Transmitter and the projector within the WirelessHD transmission range.  <a href="#">p.61</a>
Is the reception too low?	<p>If the transmissions are not strong enough, communication may be unstable.</p> <p>Check <b>Video Reception</b> as you set up the transmitter as it is sometimes possible to improve the strength of the transmission by moving the WirelessHD Transmitter or changing its direction.  <b>Settings - WirelessHD - Video Reception</b> <a href="#">p.79</a></p> <p>Transmission strength may differ depending on the surroundings, or they may be unstable. While checking <b>Video Reception</b>, setup the transmitter in a location where the number displayed remains steady.  <b>Settings - WirelessHD - Video Reception</b> <a href="#">p.79</a></p>

 Problems with USB storage devices

Slideshow does not start



Check	Remedy
Is the USB storage device using a security function?	You may not be able to use USB storage devices that incorporate security functions.

 Other problems

No audio, or the audio is too low

Check	Remedy
Is the audio cable connected correctly?	Try disconnecting the cable from the Audio (L-R) port, and then reconnecting.
Is the volume too low?	Adjust the volume so that you can hear the audio.  <a href="#">p.31</a>
Is it connected with an HDMI cable?	If no audio is output when connecting via an HDMI cable, set the connected equipment to PCM output.

A network cannot be connected via a wireless LAN

Check	Remedy
Is the passphrase correct?	Be aware that the passphrase is case-sensitive. If forgetting your passphrase, set a new one again.
Have you checked the Event ID?	<p>Check the number of the Event ID, and try the following remedy.  <a href="#">p.101</a></p> <p>The Event ID can be checked from the <b>Info</b> menu.  <b>Info - Projector Info - Event ID</b> <a href="#">p.87</a></p>

## Event ID

Check the number, and try the remedy as follows. If the problem persists, contact your local dealer or the nearest Epson repair center.

☛ [Epson Projector Contact List](#)

Event ID	Cause	Remedy
0432 0435	The EasyMP Network Projection failed to be started.	Restart the projector.
0434 0481 0482 0485	The network communication status is unstable.	Check the network communication status, and reconnect it after a while.
0433	Transferred images cannot be played.	Restart the EasyMP Network Projection.
0484	Communication was disconnected from the computer.	
0483 04FE	The EasyMP Network Projection exited unexpectedly.	Check the network communication status, and restart the projector.
0479 04FF	A system error occurred in the projector.	Restart the projector.
0891	The access point with the same SSID cannot be found.	Set the same SSID as that of the computer and the access point to the projector.
0892	The authentic methods of WPA/WPA2 are inconsistent.	Check that the wireless LAN security settings are correct.
0894	Communication was disconnected because of the connection with an unauthorized access point.	Check with your network administrator and follow his/her instructions.
0898	DHCP failed to be acquired.	Check that the DHCP server is operating correctly. If not using DHCP, turn off the DHCP setting.
0899	Other connection-related errors	If the problem persists even after the projector or the EasyMP Network Projection is restarted, contact us at the following address. ☛ <a href="#">Epson Projector Contact List</a>

# Maintenance

## Cleaning the Parts

You should clean the projector if it becomes dirty or if the quality of projected images starts to deteriorate.

### Warning

Do not use sprays that contain flammable gas to remove dirt and dust from the projector's lens, air filter, and so on. The projector may catch fire due to the high internal temperature of the lamp.

### Cleaning the air filter

Clean the air filter if dust has accumulated on the air filter or when the following message is displayed. **"The projector is overheating. Make sure nothing is blocking the air vent, and clean or replace the air filter."**

### Attention

- If dust collects on the air filter, it can cause the internal temperature of the projector to rise, and this can lead to problems with operation and shorten the optical engine's service life. It is recommended that you clean the air filter at least once every three months. Clean them more often than this if using the projector in a particularly dusty environment.
- Do not rinse the air filter in water. Do not use detergents or solvents.
- Lightly brush the air filter to clean it. If it is brushed too strongly, dust will be ground into the air filter and cannot be removed.

**1** Press the  button on the remote control or the control panel to turn off the power, and then disconnect the power cord.

**2** Remove the air filter cover. Hook your finger into the tab on the air filter cover, and remove it downward.

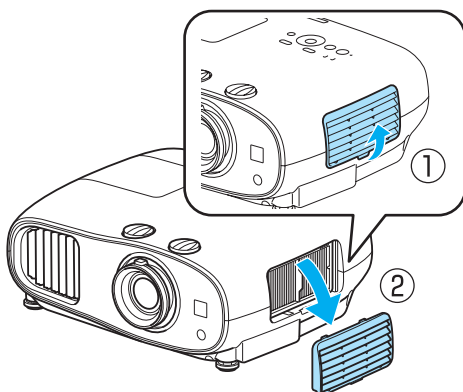

**3** Remove the air filter. Grip the knob in the center of the air filter and pull it out.

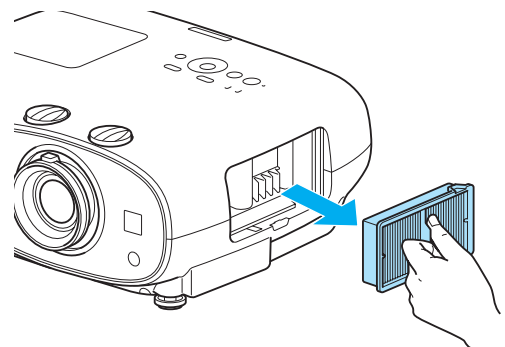

- 4** Hold the air filter with the surface facing down and tap it 4 or 5 times to remove the dust.

Turn it over and tap the other side in the same way.

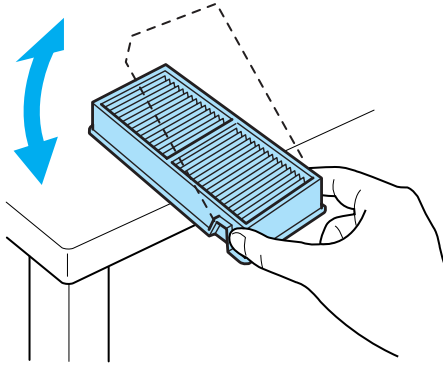

**Attention**

If the air filter is hit too hard, it may become unusable due to deformities and cracks.

- 5** Remove any dust remaining on the air filter by using a vacuum cleaner from the front side.

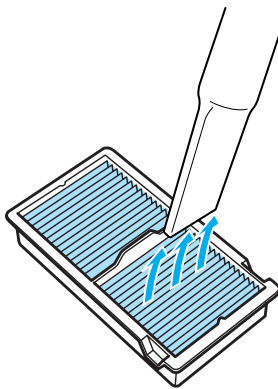

- 6** Install the air filter. Grip the air filter by the knob in the center and insert it straight.

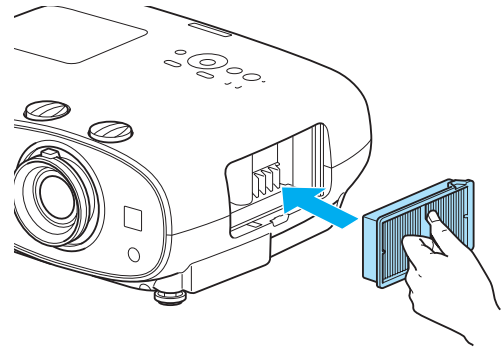

- 7** Install the air filter cover. Fasten the upper catch and then the lower one.

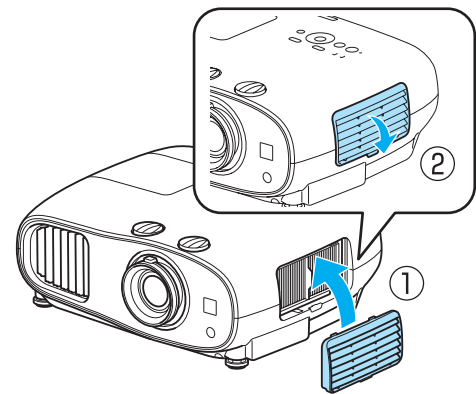

**Cleaning the main unit**

Clean the projector's surface by wiping it gently with a soft cloth.

If it is particularly dirty, moisten the cloth with water containing a small amount of neutral detergent, and then firmly wring the cloth dry before using it to wipe the surface.

**Attention**

Do not use volatile substances such as wax, alcohol, or thinner to clean the projector's surface. The quality of the case may change or the paint may peel off.



## ■ Cleaning the lens

Use a commercially available cloth for cleaning glasses to gently wipe off dirt from the lens.

### Attention

Do not rub the lens with harsh materials or handle the lens too roughly as it can easily become damaged.

## ■ Cleaning the 3D Glasses

Use the cloth to gently wipe off dirt from the lenses of the 3D Glasses.

### Attention

- Do not rub the lenses of the glasses with harsh materials or handle the lenses too roughly as they can easily become damaged.
- When maintenance is necessary, disconnect the USB Charging Adapter from the electrical outlet, and check that all cables have been disconnected.
- The 3D glasses contain rechargeable batteries. Observe local regulations when you dispose of them.

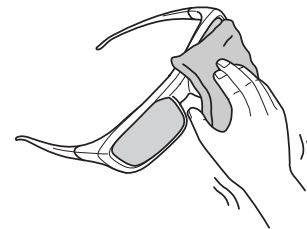

## Replacement Periods for Consumables

### ■ Air filter replacement period

- If the message is displayed even though the air filter has been cleaned  [p.102](#)

### ■ Lamp replacement period

- The following message is displayed when projection starts  
**"It is time to replace your lamp. Please contact your Epson projector reseller or visit [www.epson.com](http://www.epson.com) to purchase."**
- The projected image gets darker or starts to deteriorate.



- The lamp replacement message is set to appear after 3400H in order to maintain the initial brightness and quality of the projected images. The message display time changes depending on the usage situation, such as the color mode setting and so on.  
If you continue to use the lamp after the replacement period has passed, the possibility that the lamp may explode increases. When the lamp replacement message appears, replace the lamp with a new one as soon as possible, even if it is still working.
- Depending on the characteristics of the lamp and the way it has been used, the lamp may become darker or stop working before the lamp warning message appears. You should always have a spare lamp unit ready in case it is needed.

## Replacing Consumables

### Replacing the air filter



Dispose of used air filters properly in accordance with your local regulations.  
Material: Polypropylene

- 1 Press the  button on the remote control or the control panel to turn off the power, and then disconnect the power cord.

- 2 Remove the air filter cover.  
Hook your finger into the tab on the air filter cover, and remove it downward.

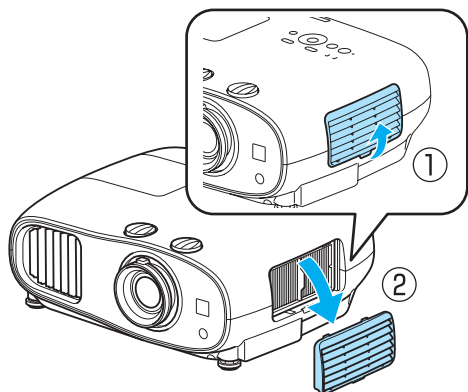

- 3 Remove the old air filter.  
Grip the knob in the center of the air filter and pull it out.

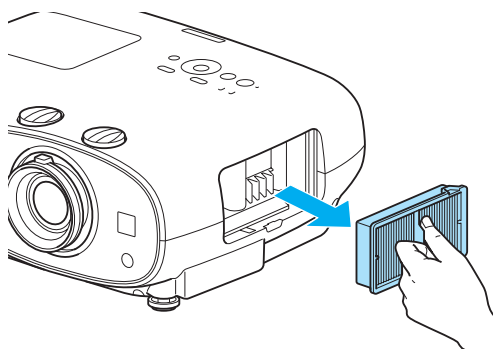

- 4 Install the new air filter.  
Grip the air filter by the knob in the center and insert it straight.

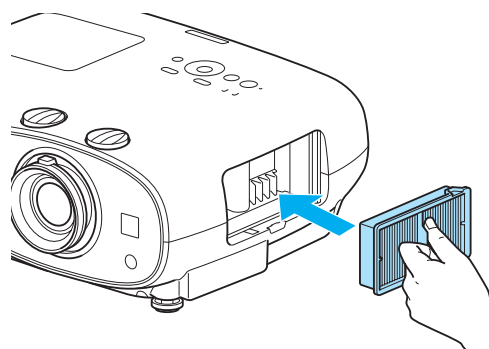

- 5 Install the air filter cover.  
Fasten the outside catch and then the lower one.

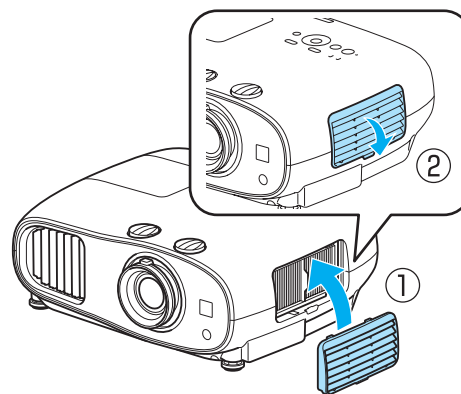

## ■ Replacing the lamp

### ⚠ Warning

When replacing the lamp because it has stopped illuminating, there is a possibility that the lamp may be broken. If replacing the lamp of a projector that has been suspended from the ceiling, you should always assume that the lamp is cracked, and remove the lamp cover with care. When you open the lamp cover, small shards of glass could fall out. If any shards of glass get into your eyes or mouth, contact a doctor immediately.

### ⚠ Caution

- Do not touch the lamp cover immediately after turning off the projector as it is still hot. Wait until the lamp has cooled down sufficiently before removing the lamp cover. Otherwise, you could get burnt.
- We recommend the use of genuine EPSON option lamps. The use of non-genuine lamps may affect projection quality and safety.  
Any damage or malfunction caused by the use of non-genuine lamps may not be covered by Epson's warranty.

- 1 Press the  button on the remote control or the control panel to turn off the power, and then disconnect the power cord.

- 2 Loosen the lamp cover fixing screw.

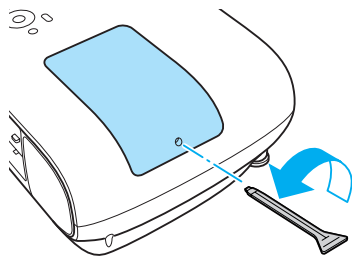

- 3 Remove the lamp cover.  
Slide the lamp cover straight forward and remove it.

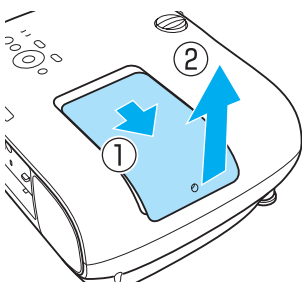

- 4 Loosen the two lamp fixing screws.

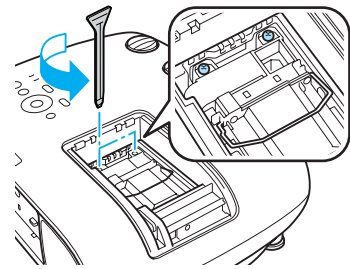

- 5 Remove the old lamp.  
Grip the knob firmly and pull it straight out.

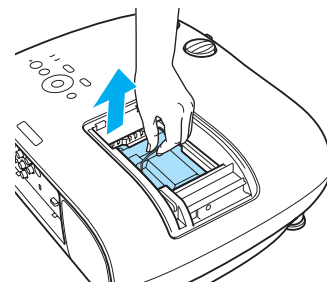

- 6** Install the new lamp.  
Make sure the lamp is facing the correct direction and press it in.

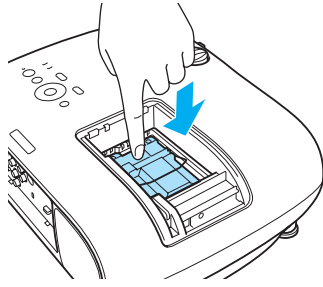

- 7** Tighten the two lamp fixing screws.

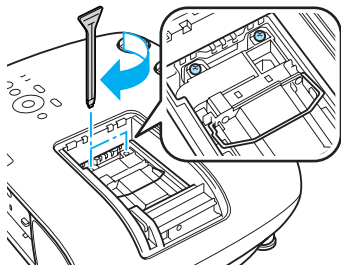

- 8** Replace the lamp cover.  
Slide the cover back into place.

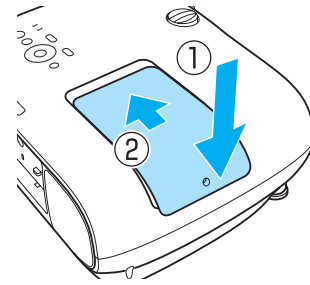

- 9** Tighten the lamp cover fixing screw.

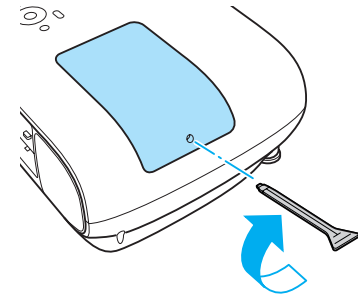

**Warning**

Do not disassemble or remodel the lamp. If a modified or disassembled lamp is installed in the projector and used, it could cause a fire, electric shock, or an accident.

**Caution**

- Make sure you install the lamp and lamp cover securely. If they are not installed correctly, the power does not turn on.
- The lamp contains mercury (Hg). Dispose of used lamps in accordance with your local laws and regulations on disposing of fluorescent tubing.

## Resetting lamp hours

After replacing the lamp, make sure you reset the lamp hours.



The projector records how long the lamp is turned on and a message and indicator notify you when it is time to replace the lamp.

1 Turn on the power.

2 Press the  button.  
The Configuration menu is displayed.

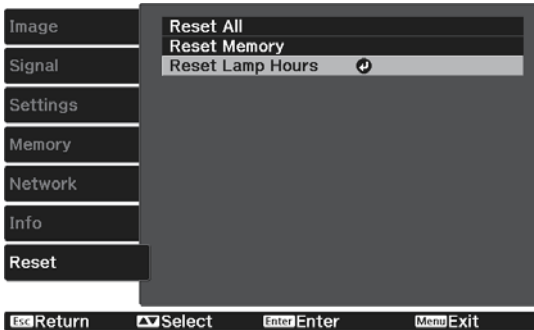
3 Select **Reset - Reset Lamp Hours**.  
A reset confirmation message is displayed.



4 Use the   buttons to select **Yes**, and then press the  button to execute.

The lamp hours are reset.

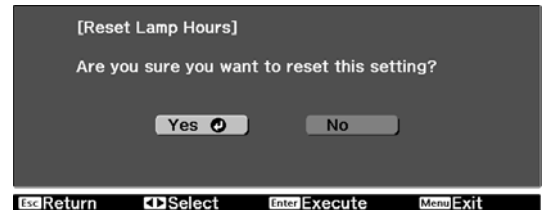



## Optional Accessories and Consumables

The following optional accessories and consumables are available for purchase if required. This list of optional accessories and consumables is current as of: 2014.7. Details of accessories are subject to change without notice.

Availability may vary depending on the country of purchase.

### Optional Items

Name	Model No.	Explanation
Ceiling mount*	ELPMB20	Use when installing the projector on a ceiling.
	ELPMB22	
	ELPMB30	
Ceiling pipe 450 (450 mm white)*	ELPFP13	Use when installing the projector on a high ceiling.
Ceiling pipe 700 (700 mm white)*	ELPFP14	
Active shutter 3D Glasses	ELPGS03	These are Bluetooth active shutter 3D glasses. Use when viewing 3D images with this projector.
USB Charging Adapter	ELPAC01	Use when charging the 3D Glasses.
Wireless LAN unit 802.11b/g/n (2.4 GHz)	ELPAP07	Use when connecting an external device to the projector via a wireless LAN to project images.

\* Special expertise is required to suspend the projector from a ceiling. Contact your local dealer.

### Consumables

Name	Model No.	Explanation
Lamp unit	ELPLP85	Use as a replacement for used lamps. (1 lamp)
Air filter	ELPAF39	Use as a replacement for used air filters. (1 air filter)



# Supported Resolutions

## Component Video

Signal	Refresh Rate (Hz)	Resolution (dots)
SDTV (480i)	60	720 x 480
SDTV (576i)	50	720 x 576
SDTV (480p)	60	720 x 480
SDTV (576p)	50	720 x 576
HDTV (720p)	50/60	1280 x 720
HDTV (1080i)	50/60	1920 x 1080
HDTV (1080p)	50/60	1920 x 1080

## Composite Video

Signal	Refresh Rate (Hz)	Resolution (dots)
TV (NTSC)	60	720 x 480
TV (SECAM)	50	720 x 576
TV (PAL)	50/60	720 x 576

## Computer Signals (Analog RGB)

Signal	Refresh Rate (Hz)	Resolution (dots)
VGA	60	640 x 480
SVGA	60	800 x 600
XGA	60	1024 x 768
SXGA	60	1280 x 960
	60	1280 x 1024
WXGA	60	1280 x 768
	60	1366 x 768
	60	1280 x 800
WXGA++	60	1600 x 900

## HDMI1/HDMI2 Input Signal

Signal	Refresh Rate (Hz)	Resolution (dots)
VGA	60	640 x 480
SDTV (480i)	60	720 x 480
SDTV (576i)	50	720 x 576

Signal	Refresh Rate (Hz)	Resolution (dots)
SDTV (480p)	60	720 x 480
SDTV (576p)	50	720 x 576
HDTV (720p)	50/60	1280 x 720
HDTV (1080i)	50/60	1920 x 1080
HDTV (1080p)	24/30/50/60	1920 x 1080

### MHL Input Signal

Signal	Refresh Rate (Hz)	Resolution (dots)
VGA	60	640 x 480
SDTV (480i)	50	720 x 480
SDTV (576i)	60	720 x 576
SDTV (480p)	50	720 x 480
SDTV (576p)	60	720 x 576
HDTV (720p)	50/60	1280 x 720
HDTV (1080i)	50/60	1920 x 1080
HDTV (1080p)	24/30	1920 x 1080

### 3D Input Signal HDMI

Signal	Refresh Rate (Hz)	Resolution (dots)	3D Format		
			Frame Packing	Side by Side	Top and Bottom
HDTV (720p)	50/60	1280 x 720	✓	✓	✓
HDTV (1080i)	50/60	1920 x 1080	-	✓	-
HDTV (1080p)	50/60	1920 x 1080	-	✓	-
HDTV (1080p)	24	1920 x 1080	✓	✓	✓

### WirelessHD Input Signal

Signal	Refresh Rate (Hz)	Resolution (dots)
VGA	60	640 x 480
SDTV (480i)	60	720 x 480
SDTV (576i)	50	720 x 576
SDTV (480p)	60	720 x 480
SDTV (576p)	50	720 x 576
HDTV (720p)*	50/60	1280 x 720
HDTV (1080i)	50/60	1920 x 1080
HDTV (1080p)*	24/50/60	1920 x 1080



\* When projecting in WirelessHD, the following signals do not support Deep Color.

2D: 1080p 60/50 Hz

3D: 1080P 24 Hz frame packing/720P 50/60 Hz frame packing/1080p 60/50 Hz side by side

### 3D Input Signal MHL (via a WirelessHD Transmitter\*)

Signal	Refresh Rate (Hz)	Resolution (dots)	3D Format		
			Frame Packing	Side by Side	Top and Bottom
HDTV (720p)	50/60	1280 x 720	-	✓	✓
HDTV (1080i)	50/60	1920 x 1080	-	✓	-
HDTV (1080p)	50/60	1920 x 1080	-	-	-
HDTV (1080p)	24	1920 x 1080	-	✓	✓

\* HDMI5 port only



# Specifications

Product name		EH-TW6600W	EH-TW6600
Appearance (not including adjustable foot)		410 (W) x 157 (H) x 304 (D) mm	
Panel Size		0.61" wide	
Display method		Polysilicon TFT active matrix	
Resolution		1920 (W) x 1080 (H) x 3	
Scanning Frequency	Digital	Pixel clock: 13.5 - 148.5 MHz	
		Horizontal: 15.63 - 67.5 kHz	
		Vertical: 24, 30, 50 - 60 Hz	
	Analog	Pixel clock: 13.5 - 148.5 MHz	
		Horizontal: 15.63 - 67.5 kHz	
		Vertical: 50 - 60 Hz	
Focus adjustment		Manual	
Zoom adjustment		Manual (approx. 1 to 1.6)	
Lamp (light source)		UHE lamp 250 W, Model No.: ELPLP85	
Power supply		100 - 240 V AC $\pm$ 10%, 50/60 Hz, 3.9-1.8 A	
Power consumption	100 to 120 V area	Operating: 385 W	
		Standby power consumption: 0.29 W Standby power consumption: 1.6 W*1	
	220 to 240 V area	Operating: 366 W	
		Standby power consumption: 0.43 W Standby power consumption: 1.8 W*1	
Operating altitude		Altitude 0 to 3000 m	
Operating temperature		+5 to 35°C*2 (No condensation)	
Storage temperature		-10 to +60°C (No condensation)	
Mass		Approx. 6.8 kg	Approx. 6.7 kg
Connectors		Component port x 1, 3RCA pin jack	
		PC port x 1, Mini D-Sub15-pin (female) blue	
		HDMI port x 2, HDMI For HDCP, For CEC signals, For MHL signals (HDMI1 port only), For linear PCM, Deep Color	
		Video port x 1, RCA pin jack	
		RS-232C port x 1, D-sub 9-pin (male)	
		Trigger Out port x 1, 3.5 mm mini jack	
		Audio-L/R port x 1, RCA pin jack	
		Audio Out port x 1, stereo mini-pin jack	
		USB 2.0 TypeA port x 1	
		Speaker	

\*1 When using the WirelessHD Transmitter with EH-TW6600W, and the following conditions are satisfied

**Settings - WirelessHD - WirelessHD** is set to **On**

**Settings - HDMI Link - Power On Link** is set to **Bidirectional** or **Device -> PJ**  [p.79](#)

\*2 For use at an altitude of 2286 m or higher, it is +5 to +30°C.

This product is also designed for IT power distribution system with phase-to-phase voltage 230V.

Обладнання відповідає вимогам Технічного регламенту обмеження використання деяких небезпечних речовин в електричному та електронному обладнанні.



### Angle of tilt

If you use the projector tilted at an angle of more than 10°, it could be damaged or cause an accident.

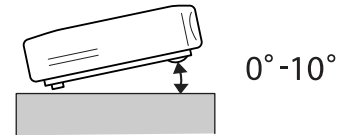

### ESC/VP21 Commands

Use of ESC/VP21 enables control of the projector from an external device. For more details, see the following Web site.

<http://www.epson.com>

### RS-232C Cable layouts

- Connector shape: D-sub 9-pin (male)
- Projector input port name: RS-232C
- Signal name:

Signal Name	Function
GND	Signal wire ground
TD	Transmit data
RD	Receive data

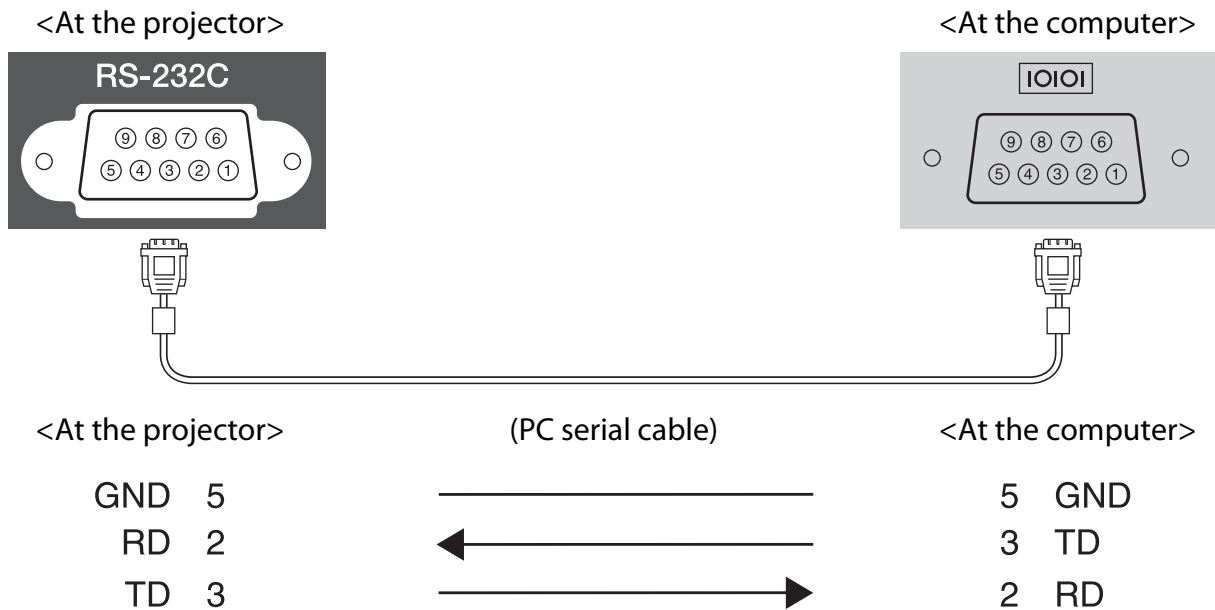

- Communications protocol
  - Default baud rate setting: 9600 bps
  - Data length: 8 bit
  - Parity: None
  - Stop-bit: 1 bit
  - Flow control: None

### **Indication of the manufacturer and the importer in accordance with requirements of directive 2011/65/EU (RoHS)**

Manufacturer: SEIKO EPSON CORPORATION

Address: 3-5, Owa 3-chome, Suwa-shi, Nagano-ken 392-8502 Japan

Telephone: 81-266-52-3131

Importer: SEIKO EUROPE B.V.

Address: Azië building, Atlas Arena, Hoogoorddreef 5, 1101 BA Amsterdam Zuidoost The Netherlands

Telephone: 31-20-314-5000

**DECLARATION of CONFORMITY**

According to 47CFR, Part 2 and 15

Class B Personal Computers and Peripherals; and/or

CPU Boards and Power Supplies used with Class B Personal Computers

We: Epson America, Inc.  
Located at: 3840 Kilroy Airport Way  
MS: 3-13  
Long Beach, CA 90806  
Tel: 562-981-3840

Declare under sole responsibility that the product identified herein, complies with 47CFR Part 2 and 15 of the FCC rules as a Class B digital device. Each product marketed, is identical to the representative unit tested and found to be compliant with the standards. Records maintained continue to reflect the equipment being produced can be expected to be within the variation accepted, due to quantity production and testing on a statistical basis as required by 47CFR 2.909. Operation is subject to the following two conditions : (1) this device may not cause harmful interference, and (2) this device must accept any interference received, including interference that may cause undesired operation.

Trade Name: EPSON  
Type of Product: LCD Projector  
Model: H651C/H652C/H653C

**FCC Compliance Statement****For United States Users**

This equipment has been tested and found to comply with the limits for a Class B digital device, pursuant to Part 15 of the FCC Rules. These limits are designed to provide reasonable protection against harmful interference in a residential installation. This equipment generates, uses, and can radiate radio frequency energy and, if not installed and used in accordance with the instructions, may cause harmful interference to radio communications. However, there is no guarantee that interference will not occur in a particular installation. If this equipment does cause harmful interference to radio or television reception, which can be determined by turning the equipment off and on, the user is encouraged to try to correct the interference by one or more of the following measures.

- Reorient or relocate the receiving antenna.
- Increase the separation between the equipment and receiver.
- Connect the equipment into an outlet on a circuit different from that to which the receiver is connected.
- Consult the dealer or an experienced radio/TV technician for help.

**WARNING**

The connection of a non-shielded equipment interface cable to this equipment will invalidate the FCC Certification or Declaration of this device and may cause interference levels which exceed the limits established by the FCC for this equipment. It is the responsibility of the user to obtain and use a shielded equipment interface cable with this device. If this equipment has more than one interface connector, do not leave cables connected to unused interfaces. Changes or modifications not expressly approved by the manufacturer could void the user's authority to operate the equipment.



# Glossary

This section briefly explains the difficult terms that are not explained in context in the text of this guide. For details, refer to other commercially available publications.

HDCP	HDCP is an abbreviation for High-bandwidth Digital Content Protection. It is used to prevent illegal copying and protect copyrights by encrypting digital signals sent over DVI and HDMI ports. Because the HDMI port on this projector supports HDCP, it can project digital images protected by HDCP technology. However, the projector may not be able to project images protected with updated or revised versions of HDCP encryption.
HDMI™	An abbreviation for High Definition Multimedia Interface. This is the standard by which HD images and multichannel audio signals are digitally transmitted.  HDMI™ is a standard aimed at digital consumer electronics and computers. By not compressing the digital signal, the image can be transferred at the highest quality possible. It also provides an encryption function for the digital signal.
HDTV	An abbreviation for High-Definition Television. This refers to high-definition systems which satisfy the following conditions. <ul style="list-style-type: none"> <li>• Vertical resolution of 720p or 1080i or greater (p = Progressive, i = Interlace)</li> <li>• Screen aspect of 16:9 Dolby Digital audio reception and playback (or output)</li> </ul>
MHL	An abbreviation for Mobile High-definition Link, which is a standard high-definition interface that enables high-speed transfer of video signals on mobile devices.  It is a standard targeting smartphones and tablets that transfers uncompressed digital signals without loss of quality and also enables simultaneous charging of such devices.
NTSC	An abbreviation for the National Television Standards Committee. A terrestrial analog color broadcasting method. This method is used in Japan, North America, and Latin America.
PAL	An abbreviation for Phase Alternation by Line. A terrestrial analog color broadcasting method. This method is used in various Western European countries (with the exception of France), Asian countries such as China, and Africa.
SDTV	An abbreviation for Standard Definition Television. This refers to standard television systems which do not satisfy the conditions for HDTV High-Definition Television.
SECAM	An abbreviation for SEquential Couleur A Memoire. A terrestrial analog color broadcasting method. This method is used in France, Eastern Europe, the former Soviet Union, the Middle East, Africa, and so on.
SVGA	A screen size standard with a resolution of 800 (horizontal) x 600 (vertical) dots.
SXGA	A screen size standard with a resolution of 1,280 (horizontal) x 1,024 (vertical) dots.
VGA	A screen size standard with a resolution of 640 (horizontal) x 480 (vertical) dots.
XGA	A screen size standard with a resolution of 1,024 (horizontal) x 768 (vertical) dots.
YCbCr	In component image signals for SDTV, Y is the brightness, while Cb and Cr indicate the color difference.
YPbPr	In component image signals for HDTV, Y is the brightness, while Pb and Pr indicate the color difference.
Aspect Ratio	The ratio between an image's length and its height. Screens with a horizontal:vertical ratio of 16:9, such as HDTV screens, are known as wide screens.  SDTV and general computer displays have an aspect ratio of 4:3.

<b>Interlace</b>	Transmits information needed to create one screen by sending every other line, starting from the top of the image and working down to the bottom. Images are more likely to flicker because one frame is displayed every other line.
<b>Pairing</b>	Register devices in advance when connecting with Bluetooth devices to ensure mutual communication.



## General Notes

All rights reserved. No part of this publication may be reproduced, stored in a retrieval system, or transmitted in any form or by any means, electronic, mechanical, photocopying, recording, or otherwise, without the prior written permission of Seiko Epson Corporation. No patent liability is assumed with respect to the use of the information contained herein. Neither is any liability assumed for damages resulting from the use of the information contained herein.

Neither Seiko Epson Corporation nor its affiliates shall be liable to the purchaser of this product or third parties for damages, losses, costs, or expenses incurred by the purchaser or third parties as a result of: accident, misuse, or abuse of this product or unauthorized modifications, repairs, or alterations to this product, or (excluding the U.S.) failure to strictly comply with Seiko Epson Corporation's operating and maintenance instructions.

Seiko Epson Corporation shall not be liable against any damages or problems arising from the use of any options or any consumable products other than those designated as Original Epson Products or Epson Approved Products by Seiko Epson Corporation.

The contents of this guide may be changed or updated without further notice.

Illustrations in this guide and the actual projector may differ.

### Restriction of Use

When this product is used for applications requiring high reliability/safety such as transportation devices related to aviation, rail, marine, automotive etc.; disaster prevention devices; various safety devices etc; or functional/precision devices etc, you should use this product only after giving consideration to including fail-safes and redundancies into your design to maintain safety and total system reliability. Because this product was not intended for use in applications requiring extremely high reliability/safety such as aerospace equipment, main communication equipment, nuclear power control equipment, or medical equipment related to direct medical care etc, please make your own judgment on this product's suitability after a full evaluation.

## General Notice

EPSON is a registered trademark, EXCEED YOUR VISION, ELPLP and their logos are registered trademarks or trademarks of Seiko Epson Corporation.

HDMI and High-Definition Multimedia Interface are the trademarks or registered trademarks of HDMI Licensing LLC.  HIGH DEFINITION MULTIMEDIA INTERFACE

WirelessHD, WiHD, and the WiHD logo are trademarks or registered trademarks of WirelessHD LLC.

InstaPrevue and the InstaPrevue logo are the trademarks or registered trademarks of Silicon Image, Inc.

Bluetooth® and the Bluetooth logo are the trademarks of Bluetooth SIG, Inc.

MHL and the MHL logo are a trademark, registered trademark or service mark of MHL, LLC in the United States and/or other countries.

WPA™ and WPA2™ are registered trademarks of Wi-Fi Alliance.

App Store is a service mark of Apple Inc.

Google Play is a trademark of Google Inc.

All other trademarks are the property of their respective owners and used for identification purpose only.

©SEIKO EPSON CORPORATION 2014. All rights reserved.



- 2**
- 2D-to-3D Conversion ..... 77
- 3**
- 3D brightness ..... 77
  - 3D depth ..... 77
  - 3D display ..... 77
  - 3D Format ..... 87
  - 3D format ..... 77
  - 3D Glasses ..... 46
  - 3D Glasses charging port ..... 54
  - 3D images ..... 46
  - 3D settings ..... 77
  - 3D viewing notice ..... 77
- A**
- Adjusting focus ..... 27
  - Adjusting RGB ..... 36
  - Adjusting the tilt ..... 28
  - Advanced ..... 76, 78
  - Air filter ..... 102
  - Air filter cover ..... 102, 105
  - Air filter replacement period ..... 104
  - Appearance ..... 12
  - Aspect ..... 33, 77
  - Audio ..... 79
  - Auto iris ..... 39, 76
  - Auto setup ..... 78
- B**
- Basic menu ..... 85
  - Brightness ..... 35, 75, 76
- C**
- CEC standards ..... 68
  - Channel ..... 85
  - Child lock ..... 80
  - Cleaning the 3D Glasses ..... 104
  - Cleaning the air filter ..... 102
  - Cleaning the lens ..... 104
  - Cleaning the main unit ..... 103
  - Color mode ..... 32, 75
  - Color Saturation ..... 75
  - Color Temp. .... 75
  - Component port ..... 18
  - Configuration menu ..... 74
  - Connecting ..... 18
  - Connecting a computer ..... 19
  - Connecting MHL compatible devices ..... 20, 21
- Connecting smartphones or tablets ..... 20, 21
  - Connecting USB devices ..... 20
  - Connecting video equipment ..... 18
  - Connecting WirelessHD devices ..... 21
  - Connection Mode ..... 85
  - Contrast ..... 75
  - Control panel ..... 6, 7
  - Control panel lock ..... 80
  - Cool-down ..... 25
- D**
- Deep color ..... 87
  - Deinterlacing ..... 77
  - Detail Enhancement ..... 39, 78
  - Device Connections ..... 79, 80
  - Device connections ..... 60
  - DHCP ..... 86
  - Diagonal Screen Size ..... 77
  - Direct power on ..... 82
  - Display ..... 83
  - Display Background ..... 83
  - Displaying the test pattern ..... 27
- E**
- EPSON Super White ..... 76
  - Erase memory ..... 44, 84
  - Error/Warning indicators ..... 89
  - Event ID ..... 87, 101
  - Exit Picture in Picture ..... 88
- F**
- Focus ..... 94
  - Focus adjustment ..... 27
  - Focus ring ..... 6, 27
  - Full ..... 33
- G**
- Gain ..... 36, 76
  - Gamma ..... 35, 76
  - Gateway Address ..... 86
- H**
- H/V-Keystone ..... 30, 79
  - HDMI Link ..... 79
  - HDMI link ..... 68
  - HDMI port ..... 68
  - HDMI video range ..... 78
  - HDMI1 port ..... 18, 19, 20, 21
  - HDMI2 port ..... 18, 19
  - High altitude mode ..... 82

- H-Keystone ..... 79  
Hue ..... 35, 76
- I**
- Illumination ..... 82  
Image ..... 32  
Image menu ..... 75  
Image processing ..... 78  
Images ..... 70  
Indicators ..... 89  
Info menu ..... 87  
Input signal ..... 87  
Inverse 3D Glasses ..... 77  
Inverse audio ..... 79  
IP Address ..... 86  
IP address display ..... 86  
IP Settings ..... 86
- K**
- Keystone distortion ..... 30
- L**
- Lamp cover ..... 6, 106  
Lamp cover fixing screw ..... 106  
Lamp hours ..... 87  
Lamp replacement period ..... 104  
Language ..... 83  
Link indicator ..... 54  
Load memory ..... 44, 84  
Lock setting ..... 80
- M**
- Memory function ..... 43  
Memory menu ..... 84  
Menu ..... 74  
Messages ..... 83  
Motion detection ..... 77
- N**
- Network menu ..... 84  
Noise ..... 94  
Noise reduction ..... 78
- O**
- Offset ..... 36, 76  
Operating range ..... 23  
Operating time ..... 108  
Operation ..... 82  
Overscan ..... 78
- P**
- Pairing ..... 47  
Panel Alignment ..... 83  
Passphrase ..... 86  
Pattern Color ..... 83  
PC port ..... 19  
Picture in Picture ..... 72, 88  
Position ..... 77  
Power ..... 25  
Power consumption ..... 76  
Power Off Link ..... 79  
Power On Link ..... 79  
Power supply ..... 24  
Projection ..... 81  
Projection size ..... 15, 27  
Projector Info ..... 87
- R**
- Refresh rate ..... 87  
Remote Control ..... 8  
Remote control ..... 23  
Rename memory ..... 44, 84  
Replacement periods for consumables ..... 104  
Replacement time ..... 104  
Replacing consumables ..... 105  
Replacing the air filter ..... 105  
Replacing the lamp ..... 106  
Reset ..... 76, 79, 80, 83  
Reset all ..... 87  
Reset lamp hours ..... 87, 108  
Reset memory ..... 44, 87  
Reset menu ..... 86, 87  
Resolution ..... 87  
RGB ..... 76  
RGBCMY ..... 35, 76
- S**
- Saturation ..... 35, 76  
Save memory ..... 43, 84  
Scan mode ..... 87  
Search Access Point ..... 85  
Security ..... 86  
Security menu ..... 86  
Select Color ..... 83  
Serial number ..... 87  
Settings menu ..... 79  
Setup level ..... 78  
Sharpness ..... 38, 75  
Signal menu ..... 77  
Skin Tone ..... 75  
Sleep mode ..... 82

Slideshow .....	70
Soft keyboard .....	85
Source .....	25, 87
Specifications .....	113
SSID .....	85
SSID Display .....	86
Standby Confirmation .....	83
Start Adjustments .....	83
Startup Screen .....	83
Status .....	87
Sub menu .....	74
Subnet Mask .....	86
Sub-screen .....	67
Subscreen Position .....	88
Subscreen Size .....	88
Subscreen Source .....	88
Super-resolution .....	78
Supported resolutions .....	110
Swap Main/Sub .....	88
Sync info .....	87
Sync. ....	77
<b>T</b>	
Tint .....	75
Top menu .....	74
Tracking .....	77
Transmission range .....	61
Trigger Out .....	82
<b>U</b>	
USB .....	70
USB port .....	20
User button .....	81
<b>V</b>	
Version .....	87
Video port .....	18
Video Reception .....	60, 80
Video signal .....	87
Viewing area .....	49
V-Keystone .....	79
Volume .....	31, 79
<b>W</b>	
WiHD indicator .....	54
WiHD Mode .....	80
Wireless LAN menu .....	85
Wireless LAN Power .....	85
WirelessHD .....	54, 80
<b>Z</b>	
Zoom .....	33
Zoom adjustment .....	27
Zoom ring .....	6