

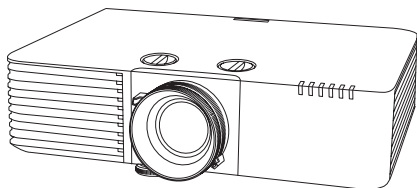

# Multimedia Projector

**EB-L615U EB-L610**  
**EB-L610U EB-L400U**  
**EB-L510U EB-L500W**  
**EB-L610W EB-L500**



EN	Quick Reference
DE	Kurzübersicht
FR	Référence rapide
IT	Riferimento rapido
ES	Referencia rápida
PT	Referência Rápida
NL	Beknopte handleiding
DA	Lynvejledning
FI	Pikaopas
NO	Hurtigreferanse
SV	Snabbreferens
CS	Rychlá reference
HU	Gyors útmutató

PL	Skrócona instrukcja obsługi
RO	Ghid informativ
EL	Γρήγορη αναφορά
TR	Hızlı Referans
SL	Hitre informacije
CA	Referència ràpida
RU	Краткое руководство
UK	Короткий довідник
KK	Қысқаша анықтама
AR	مرجع سريع
ZHS	快速参考
ZHT	快速參考
KO	빠른 참조



## ■ Unpacking

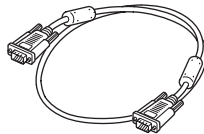
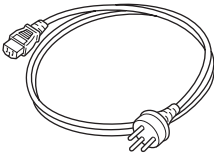
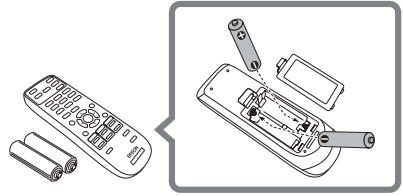
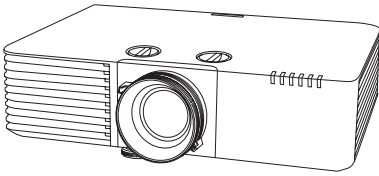

**EB-L615U/EB-L610U/EB-L510U/  
EB-L610W/EB-L610**

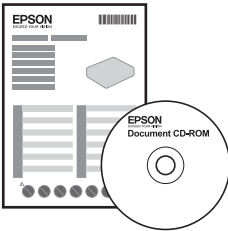
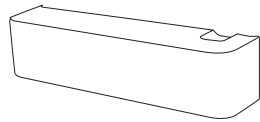

**EB-L500W/EB-L500**



**EB-L510U/EB-L610W/EB-L610/  
EB-L400U/EB-L500W/EB-L500**

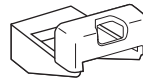

## ■ Remote Control Operating Range

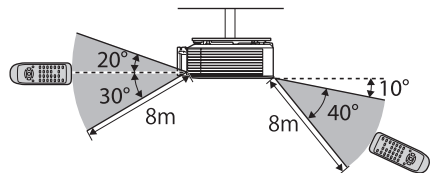
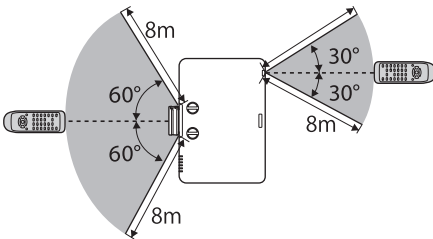

# ■ Installing

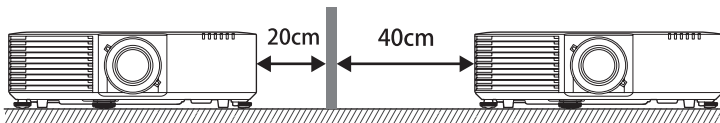
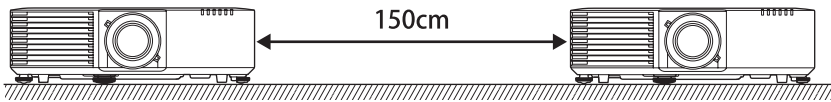
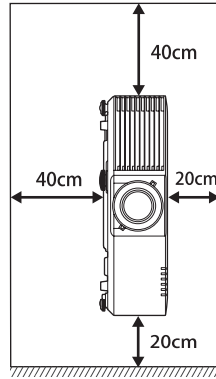
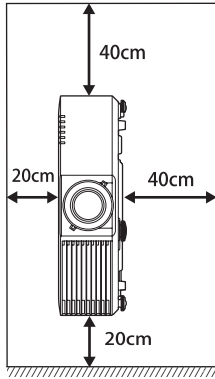
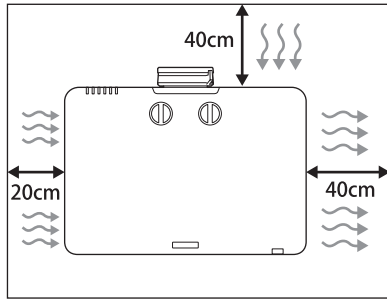

# ■ Turning On/Off the Projector

## Turning On

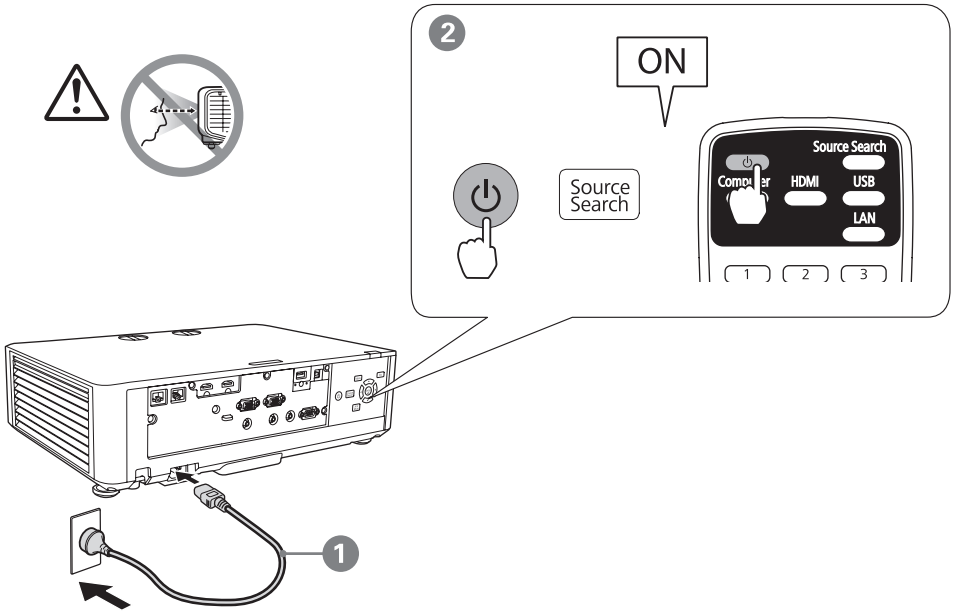

## Turning Off

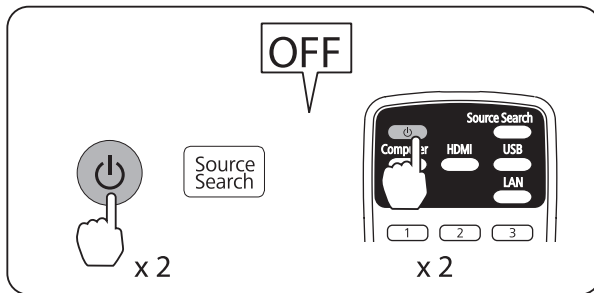

## ■ Adjusting the Projection Size

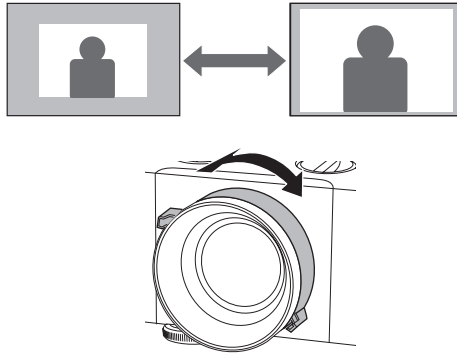

## Attaching the Zoom Ring Lock (EB-L500W/EB-L500)

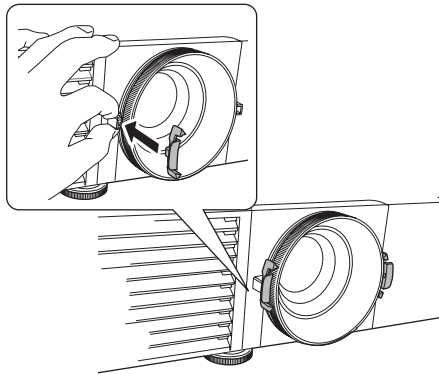

## ■ Adjusting the Focus

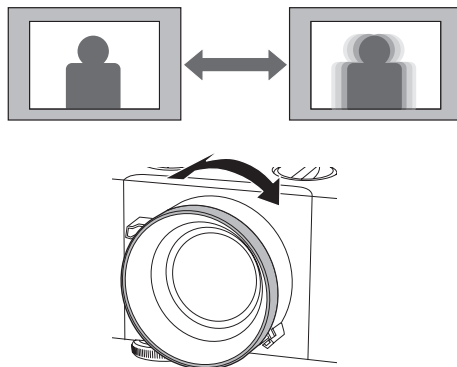

## ■ Setting the time

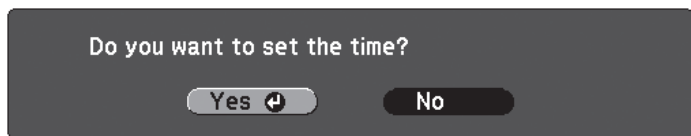

EN	When you turn on the projector for the first time, the message "Do you want to set the time?" is displayed. Select <b>Yes</b> and set Date/Time. 🖱️ User's Guide If you set it later, select <b>No</b> .
DE	Wenn Sie den Projektor zum ersten Mal einschalten, wird die Meldung "Möchten Sie die Uhrzeit einstellen?" angezeigt. Wählen Sie <b>Ja</b> und stellen Sie Datum / Zeit ein. 🖱️ Bedienungsanleitung Bei späterer Einstellung, wählen Sie <b>Nein</b> .
FR	Lorsque vous allumez le projecteur pour la première fois, le message "Voulez-vous régler l'heure ?" s'affiche. Sélectionnez <b>Oui</b> et définissez le paramètre Date/heure. 🖱️ Guide de l'utilisateur Si vous souhaitez le définir ultérieurement, sélectionnez <b>Non</b> .
IT	Quando si accende il proiettore per la prima volta, viene visualizzato il messaggio "Si desidera impostare l'ora?". Selezionare <b>Si</b> e impostare Data/Ora. 🖱️ Manuale dell'utente Se si imposta in seguito, selezionare <b>No</b> .
ES	La primera vez que encienda el proyector verá el mensaje "¿Desea ajustar la hora?". Seleccione <b>Sí</b> y configure la Fecha/Hora. 🖱️ Manual de usuario Si prefiere configurarlas en otro momento, seleccione <b>No</b> .
PT	Quando ligar o videoprojector pela primeira vez, aparece a mensagem "Deseja ajustar a hora?". Seleccione <b>Sim</b> e defina a Data / Hora. 🖱️ Manual do Utilizador Se a definir mais tarde, seleccione <b>Não</b> .
NL	De eerste keer dat u de projector inschakelt, wordt de melding "Tijd instellen?" weergegeven. Selecteer <b>Ja</b> en stel Datum/tijd in. 🖱️ Gebruikershandleiding Selecteer <b>Nee</b> als u deze optie later wilt instellen.
DA	Når du tænder projektoren første gang, vises meddelelsen "Vil du indstille tiden?". Vælg <b>Ja</b> , og indstil Dato/klokkeslæt. 🖱️ Brugervejledning Hvis du indstiller det senere, skal du vælge <b>Nej</b> .
FI	Kun kytket projektorin päälle ensimmäisen kerran, esiin tulee viesti "Haluatko asettaa ajan?". Valitse <b>Kyllä</b> ja aseta Pvm / Aika. 🖱️ Käyttöopas Jos asetat sen myöhemmin, valitse <b>Ei</b> .
NO	Når du slår på projektoren for første gang, vises meldingen "Vil du stille klokken?" Velg <b>Ja</b> , og angi Dato/klokkeslett. 🖱️ Brukerhåndbok Vil du angi dette senere, velger du <b>Nei</b> .
SV	Meddelandet "Vill du ställa in tiden?" visas när du slår på projektorn för första gången. Välj <b>Ja</b> och ställ in Datum/tid. 🖱️ Bruksanvisning Välj <b>Nej</b> om du vill ställa in det senare.
CS	Při prvním spuštění projektoru se zobrazí zpráva "Chcete nastavit čas?". Vyberte možnost <b>Ano</b> a nastavte položku Datum / čas. 🖱️ Uživatelská příručka Chcete-li provést toto nastavení později, vyberte možnost <b>Ne</b> .

HU	Amikor először kapcsolja be a kivetítőt, a "Be kívánja állítani az időt?" üzenet jelenik meg. Válassza az <b>Igen</b> lehetőséget és végezze el a Dátum / Idő beállítását.  Használati útmutató Ha később állítja be, válassza a <b>Nem</b> lehetőséget.
PL	Po pierwszym uruchomieniu projektora wyświetli się komunikat "Czy chcesz ustawić czas?". Wybierz przycisk <b>Tak</b> i ustaw opcję Data / czas.  Przewodnik użytkownika Aby ustawić ją później, wybierz przycisk <b>Nie</b> .
RO	În momentul în care porniți proiectorul pentru prima dată, pe ecran va fi afișat mesajul "Doriți să definiți ora?". Selectați <b>Da</b> și definiți Dată / Oră.  Ghidul utilizatorului Dacă le veți defini mai târziu, selectați <b>Nu</b> .
EL	Όταν ενεργοποιείτε για πρώτη φορά το βιντεοπροβολέα, εμφανίζεται το μήνυμα "Θέλετε να ρυθμίσετε την ώρα;". Επιλέξτε <b>Ναι</b> και ορίστε Ημερ./Ωρα.  Οδηγός χρήσης Για ορισμό αργότερα, επιλέξτε <b>Όχι</b> .
TR	Projektörü ilk kez açtığınızda "Süreyi belirlemek istiyor musunuz?" mesajı görüntülenir. <b>Evet</b> ögesini seçin ve Tarih / Saat seçeneğini ayarlayın.  Kullanım Kılavuzu Daha sonra ayarlayacaksanız, <b>Hayır</b> ögesini seçin.
SL	Ko prvič vklopite projektor, se prikaže sporočilo "Ali želite nastaviti čas?". Izberite <b>Da</b> in nastavite Datum/čas.  Priročnik za uporabnika Če želite nastavitev opraviti kasneje, izberite <b>Ne</b> .
CA	Quan engegueu el projector per primera vegada, apareix el missatge "Voleu ajustar l'hora?". Seleccioneu <b>Sí</b> i ajusteu Data / Hora.  Guia de l'usuari Si ho voleu ajustar més tard, seleccioneu <b>No</b> .
RU	При первом включении проектора появляется сообщение "Хотите установить время?" Выберите <b>Да</b> и задайте параметр Дата / время.  Руководство пользователя Чтобы задать этот параметр позже, выберите <b>Нет</b> .
UK	Під час першого увімкнення проектора відображається повідомлення "Бажаєте встановити час?". Виберіть <b>Так</b> і встановіть параметр Дата/час.  Посібник користувача Якщо ви встановите його пізніше, виберіть <b>Ні</b> .
KK	Проекторды бірінші рет қосқанда "Do you want to set the time?" хабары көрсетіледі. <b>Yes</b> жауабын таңдап, күнді/уақытты орнатыңыз.  Пайдаланушы нұсқаулығы Оны кейінірек орнатсаңыз, <b>No</b> жауабын таңдаңыз.
AR	عندما تقوم بتشغيل جهاز العرض للمرة الأولى، يتم عرض الرسالة "هل ترغب في تعيين الوقت؟". حدد <b>نعم</b> واضبط التاريخ/الوقت.  دليل المستخدم إذا قمت بضبطه لاحقاً، حدد لا.
ZHS	首次打开投影机时，会显示消息 " 是否要设置时间？ "。选择 <b>是</b> 并设置日期 / 时间。 使用说明书 如果要在以后设置，请选择 <b>否</b> 。
ZHT	第一次開啟投影機時，會顯示 " 想設定時間嗎？ " 訊息。選擇 <b>是</b> 並設定日期 / 時間。 使用說明書 如果您稍後設定，請選擇 <b>否</b> 。
KO	프로젝터를 처음 켜는 경우, "시간을 설정하시겠습니까?" 라는 메시지가 표시됩니다. <b>예</b> 를 선택하고 날짜 / 시간을 설정하십시오.  사용자 가이드 나중에 설정하려면, <b>아니오</b> 를 선택하십시오.

## ■ Adjusting the Position of the Image (Lens Shift)

(EB-L615U/EB-L610U/EB-L510U/EB-L610W/EB-L610)

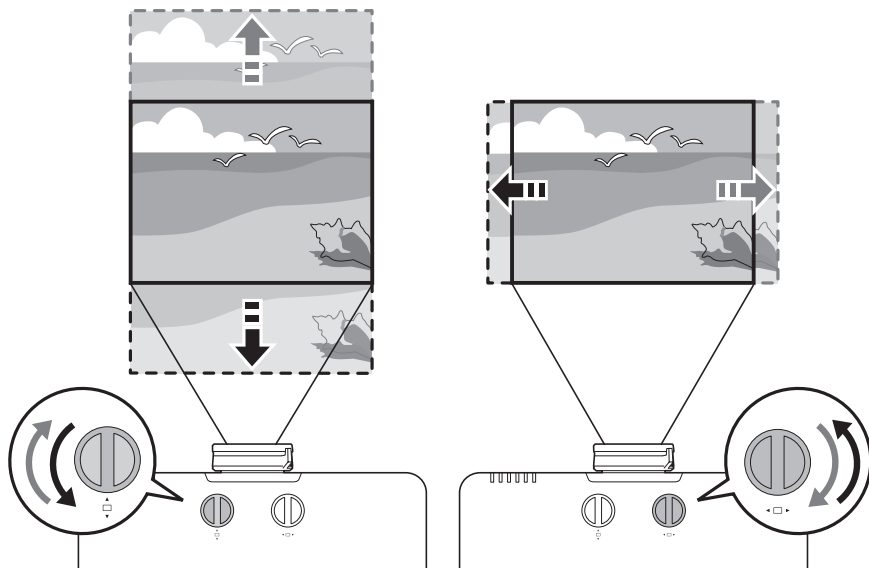



# Lens Shift Adjustment Range

EB-L615U/EB-L610U/EB-L510U/EB-L610W

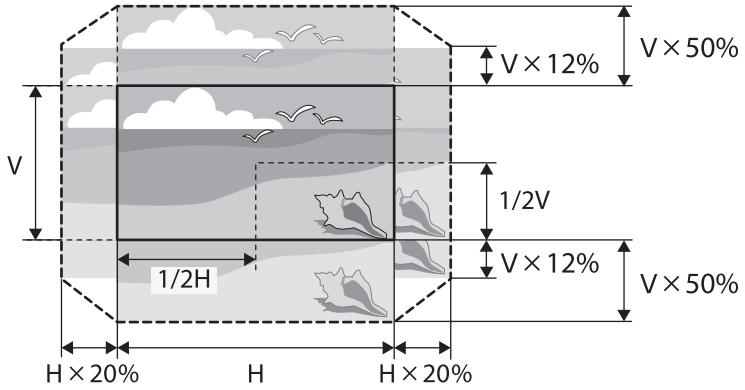

EB-L610

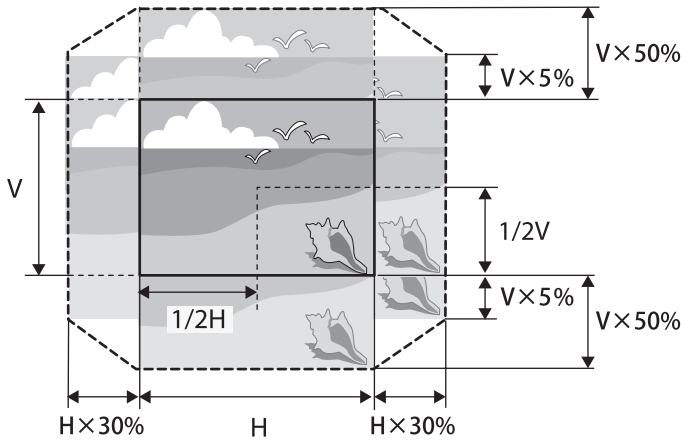

## ■ Connecting a Device

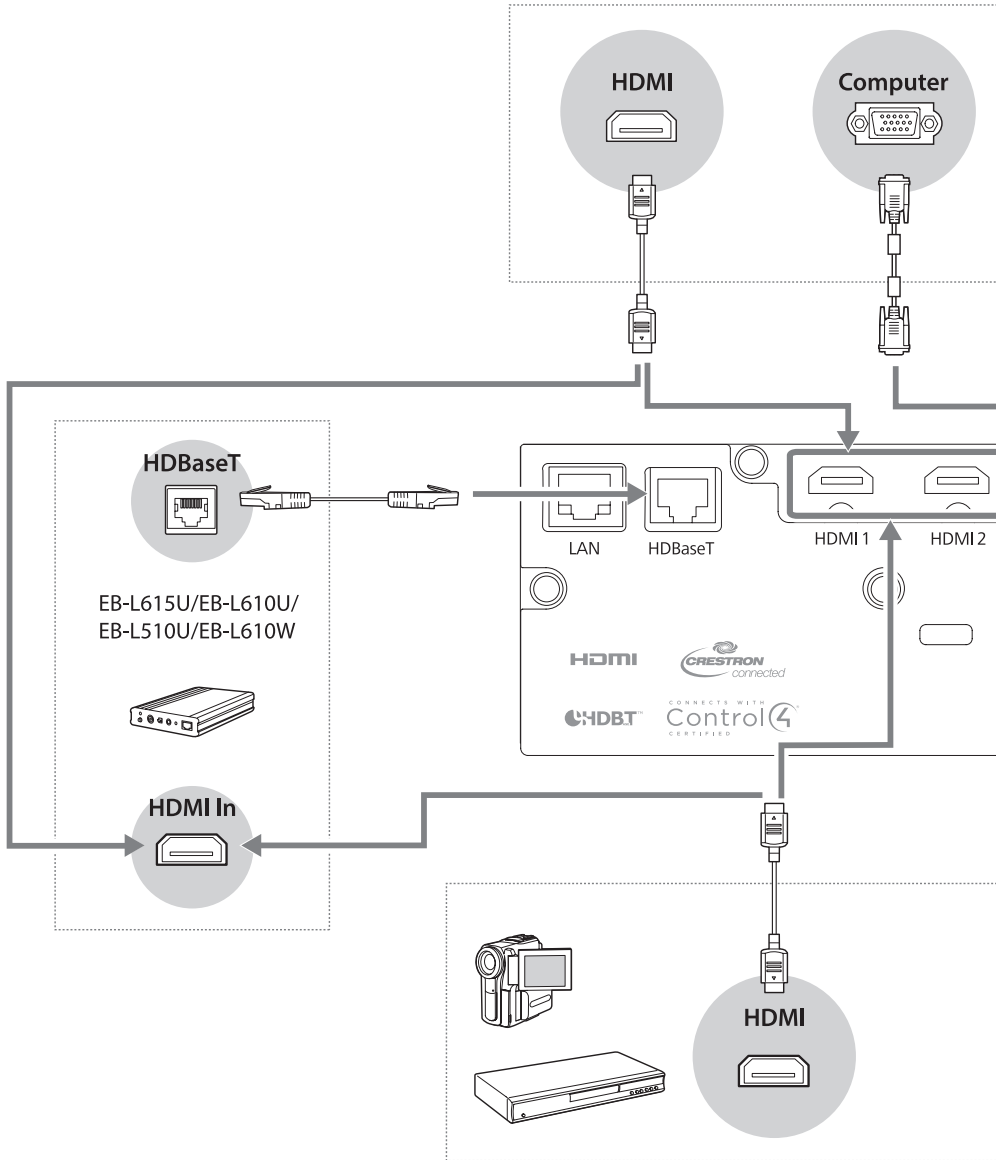

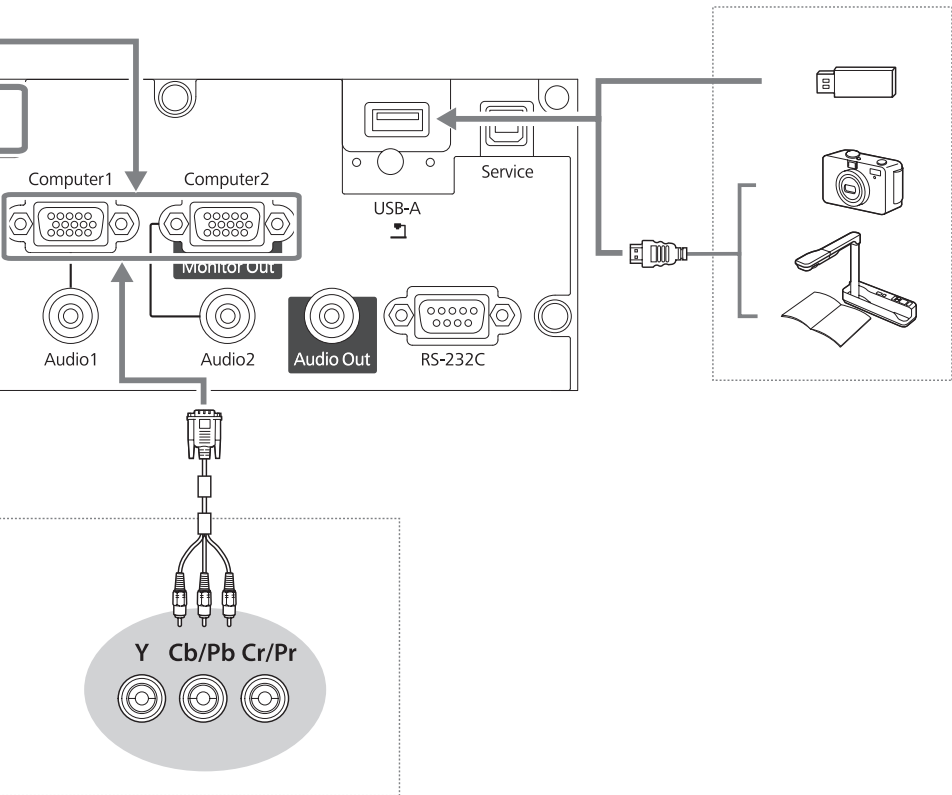
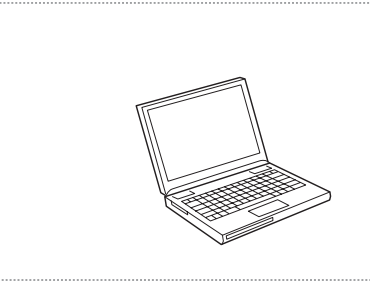

## ■ Installing the Wireless LAN Module

(EB-L510U/EB-L610W/EB-L610/EB-L400U/EB-L500W/  
EB-L500)

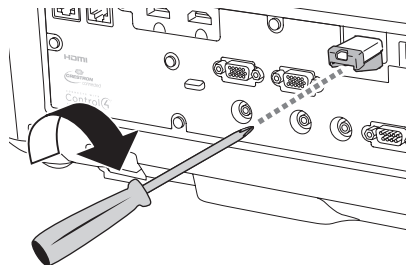
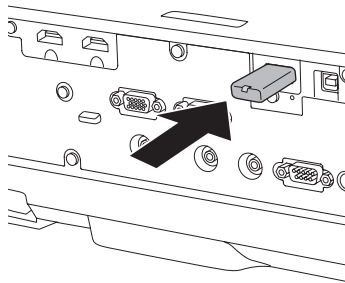
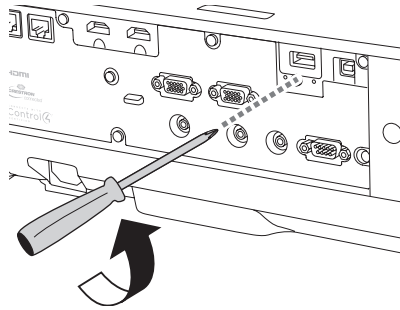

## ■ Attaching the Cable Cover

(EB-L615U/EB-L610U/EB-L510U/EB-L610W/EB-L610)

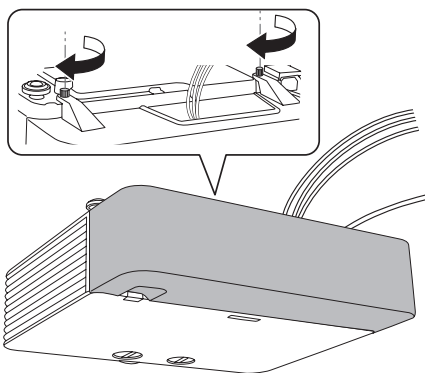
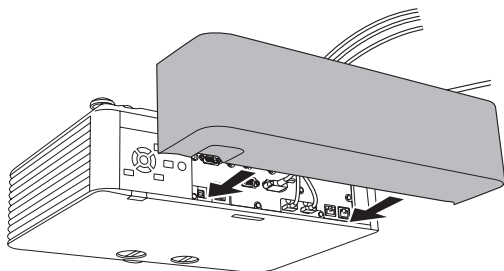
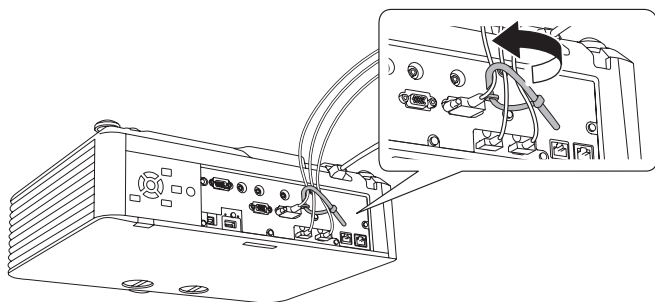

# ■ Projection Distance

## EB-L615U/EB-L610U/EB-L510U/EB-L610W/EB-L610

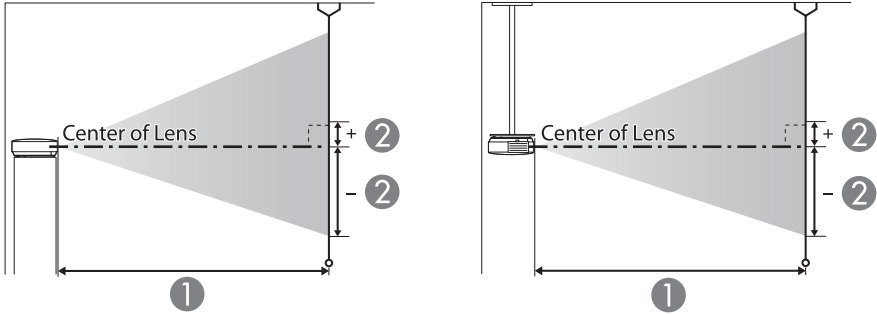

- WUXGA (EB-L615U/EB-L610U/EB-L510U)/WXGA (EB-L610W)

16:10 screen size		①	②
		Minimum (Wide) to Maximum (Tele)	Vertical Lens Shift Bottom to Top
50"	108 × 67	144 - 235	-67 - 0
60"	129 × 81	174 - 283	-81 - 0
70"	151 × 94	204 - 331	-94 - 0
80"	172 × 108	233 - 378	-108 - 0
100"	215 × 135	292 - 474	-135 - 0
120"	258 × 162	351 - 569	-162 - 0
150"	323 × 202	440 - 713	-202 - 0
200"	431 × 269	588 - 951	-269 - 0
300"	646 × 404	884 - 1429	-404 - 0
500"	1077 × 673	1476 - 2384	-673 - 0

4:3 screen size		①	②
		Minimum (Wide) to Maximum (Tele)	Vertical Lens Shift Bottom to Top
45"	91 × 69	147 - 240	-69 - 0
50"	102 × 76	164 - 267	-76 - 0
60"	122 × 91	197 - 321	-91 - 0
80"	163 × 122	264 - 429	-122 - 0
100"	203 × 152	331 - 537	-152 - 0
110"	224 × 168	365 - 591	-168 - 0
120"	244 × 183	398 - 645	-183 - 0
150"	305 × 229	499 - 807	-229 - 0
200"	406 × 305	666 - 1077	-305 - 0
300"	610 × 457	1001 - 1618	-457 - 0
440"	894 × 671	1470 - 2375	-671 - 0

16:9 screen size		①	②
		Minimum (Wide) to Maximum (Tele)	Vertical Lens Shift Bottom to Top
49"	109 × 61	145 - 237	-64 - 3
50"	111 × 62	148 - 242	-66 - 3
60"	133 × 75	179 - 291	-79 - 4
80"	177 × 100	240 - 389	-105 - 6
100"	221 × 125	301 - 487	-131 - 7
110"	244 × 137	331 - 536	-145 - 8
120"	266 × 149	361 - 585	-158 - 8
150"	332 × 187	453 - 733	-197 - 10
200"	443 × 249	605 - 978	-263 - 14
300"	664 × 374	909 - 1469	-394 - 21
480"	1063 × 598	1456 - 2352	-631 - 33

• XGA (EB-L610)

4:3 screen size		①	②
		Minimum (Wide) to Maximum (Tele)	Vertical Lens Shift Bottom to Top
48"	98 × 73	147 - 240	-73 - 0
60"	122 × 91	185 - 301	-91 - 0
70"	142 × 107	216 - 351	-107 - 0
80"	163 × 122	248 - 402	-122 - 0
100"	203 × 152	310 - 503	-152 - 0
120"	244 × 183	373 - 605	-183 - 0
150"	305 × 229	467 - 757	-229 - 0
200"	406 × 305	624 - 1010	-305 - 0
300"	610 × 457	938 - 1517	-457 - 0
470"	955 × 716	1472 - 2378	-716 - 0

16:9 screen size		①	②
		Minimum (Wide) to Maximum (Tele)	Vertical Lens Shift Bottom to Top
45"	100 × 56	150 - 245	-65 - 9
50"	111 × 62	167 - 273	-73 - 10
60"	133 × 75	202 - 328	-87 - 12
70"	155 × 87	236 - 383	-102 - 15
80"	177 × 100	270 - 438	-116 - 17
100"	221 × 125	339 - 549	-145 - 21
120"	266 × 149	407 - 659	-174 - 25
150"	332 × 187	510 - 825	-218 - 31
200"	443 × 249	681 - 1101	-291 - 42

300"	664 × 374	1023 - 1653	-436 - 62
430"	952 × 536	1468 - 2370	-625 - 89

16:10 screen size		①	②
		Minimum (Wide) to Maximum (Tele)	Vertical Lens Shift Bottom to Top
46"	99 × 62	150 - 244	-68 - 6
50"	108 × 67	163 - 265	-74 - 7
60"	129 × 81	196 - 319	-89 - 8
70"	162 × 94	229 - 372	-104 - 9
80"	172 × 108	263 - 426	-118 - 11
100"	215 × 135	329 - 534	-148 - 13
120"	258 × 162	396 - 641	-178 - 16
150"	323 × 202	496 - 802	-222 - 20
200"	431 × 269	662 - 1071	-296 - 27
300"	646 × 404	995 - 1608	-444 - 40
440"	948 × 592	1461 - 2360	-652 - 59

### EB-L400U/EB-L500W/EB-L500

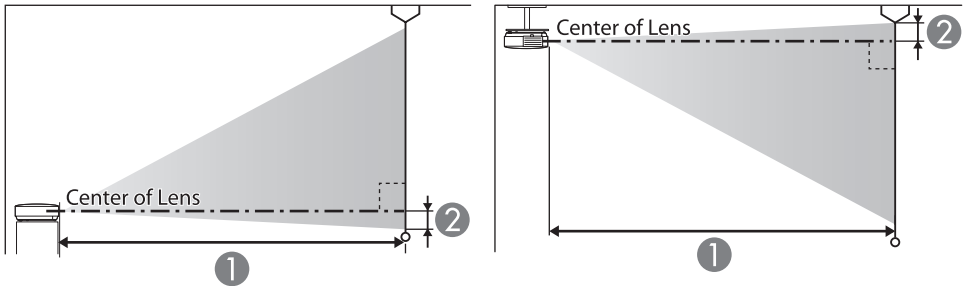

#### • WUXGA (EB-L400U)

16:10 screen size		①	②
		Minimum (Wide) to Maximum (Tele)	
50"	108 × 67	144 - 235	-2
60"	129 × 81	174 - 283	-3
70"	151 × 94	204 - 331	-3
80"	172 × 108	233 - 378	-4
100"	215 × 135	292 - 474	-5
120"	258 × 162	351 - 569	-6
150"	323 × 202	440 - 713	-7
200"	431 × 269	588 - 951	-10
300"	646 × 404	884 - 1429	-14



50"	1077 × 673	1476 - 2384	-24
-----	------------	-------------	-----

4:3 screen size		①	②
		Minimum (Wide) to Maximum (Tele)	
45"	91 × 69	147 - 240	-2
50"	102 × 76	164 - 267	-3
60"	122 × 91	197 - 321	-3
70"	142 × 107	231 - 375	-4
80"	163 × 122	264 - 429	-4
100"	203 × 152	331 - 537	-5
120"	244 × 183	398 - 645	-7
150"	305 × 229	499 - 807	-8
200"	406 × 305	666 - 1077	-11
300"	610 × 457	1001 - 1618	-16
440"	813 × 610	1470 - 2375	-24

16:9 screen size		①	②
		Minimum (Wide) to Maximum (Tele)	
49"	109 × 61	145 - 237	1
50"	111 × 62	148 - 242	1
60"	133 × 75	179 - 291	1
70"	155 × 87	209 - 340	1
80"	177 × 100	240 - 389	2
100"	221 × 125	301 - 487	2
120"	266 × 149	361 - 585	2
150"	332 × 187	453 - 733	3
200"	443 × 249	605 - 978	4
300"	664 × 374	909 - 1469	6
480"	1063 × 598	1456 - 2352	9

• WXGA (EB-L500W)

16:10 screen size		①	②
		Minimum (Wide) to Maximum (Tele)	
29"	62 × 39	85 - 140	-1
40"	86 × 54	118 - 193	-1
50"	108 × 67	149 - 243	-2
60"	129 × 81	179 - 292	-2
80"	172 × 108	239 - 390	-3
100"	215 × 135	300 - 488	-3
150"	323 × 202	451 - 733	-5
200"	431 × 269	603 - 979	-7

250"	538 × 337	754 - 1224	-8
280"	603 × 377	845 - 1371	-9

4:3 screen size		①	②
		Minimum (Wide) to Maximum (Tele)	
25"	51 × 38	83 - 136	-1
30"	61 × 46	100 - 164	-1
40"	81 × 61	134 - 219	-2
50"	102 × 76	169 - 275	-2
60"	122 × 91	203 - 331	-2
80"	163 × 122	271 - 442	-3
100"	203 × 152	340 - 553	-4
120"	244 × 183	408 - 664	-5
150"	305 × 229	511 - 831	-6
200"	406 × 305	682 - 1108	-8
250"	508 × 381	854 - 1386	-10

16:9 screen size		①	②
		Minimum (Wide) to Maximum (Tele)	
28"	62 × 35	84 - 138	1
30"	66 × 37	91 - 149	1
40"	89 × 50	122 - 199	1
50"	111 × 62	153 - 249	2
60"	133 × 75	184 - 300	2
80"	177 × 100	246 - 401	3
100"	221 × 125	308 - 502	3
150"	332 × 187	464 - 754	5
200"	443 × 249	619 - 1006	7
250"	553 × 311	775 - 1258	9
275"	609 × 342	853 - 1384	10

• XGA (EB-L500)

4:3 screen size		①	②
		Minimum (Wide) to Maximum (Tele)	
30"	61 × 46	83 - 136	-5
40"	81 × 61	111 - 182	-6
50"	102 × 76	140 - 229	-8
60"	122 × 91	169 - 275	-10
80"	163 × 122	226 - 368	-13
100"	203 × 152	283 - 460	-16

150"	305 × 229	426 - 692	-24
200"	406 × 305	568 - 923	-32
250"	508 × 381	711 - 1155	-40
300"	610 × 457	854 - 1386	-48

16:9 screen size		①	②
		Minimum (Wide) to Maximum (Tele)	
28"	62 × 35	84 - 138	1
30"	66 × 37	91 - 149	1
40"	89 × 50	122 - 199	1
50"	111 × 62	153 - 249	2
60"	133 × 75	184 - 300	2
80"	177 × 100	246 - 401	3
100"	221 × 125	308 - 502	3
150"	332 × 187	464 - 754	5
200"	443 × 249	619 - 1006	7
250"	553 × 311	775 - 1258	9
275"	609 × 342	853 - 1384	10

16:10 screen size		①	②
		Minimum (Wide) to Maximum (Tele)	
29"	62 × 39	85 - 140	-1
40"	86 × 54	118 - 193	-1
50"	108 × 67	149 - 243	-2
60"	129 × 81	179 - 292	-2
70"	151 × 94	209 - 341	-2
80"	172 × 108	239 - 390	-3
100"	215 × 135	300 - 488	-3
150"	323 × 202	451 - 733	-5
200"	431 × 269	603 - 979	-7
250"	538 × 337	754 - 1224	-8
280"	603 × 377	845 - 1371	-9

## External Dimensions

Unit : mm

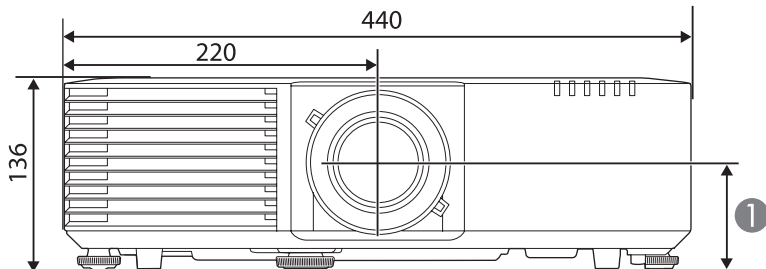

① Distance from center of lens to suspension bracket fixing point

EB-L615U/EB-L610U/EB-L510U/EB-L610W/EB-L610: 74 mm

EB-L400U: 78.2 mm

EB-L500W/EB-L500: 77.8 mm

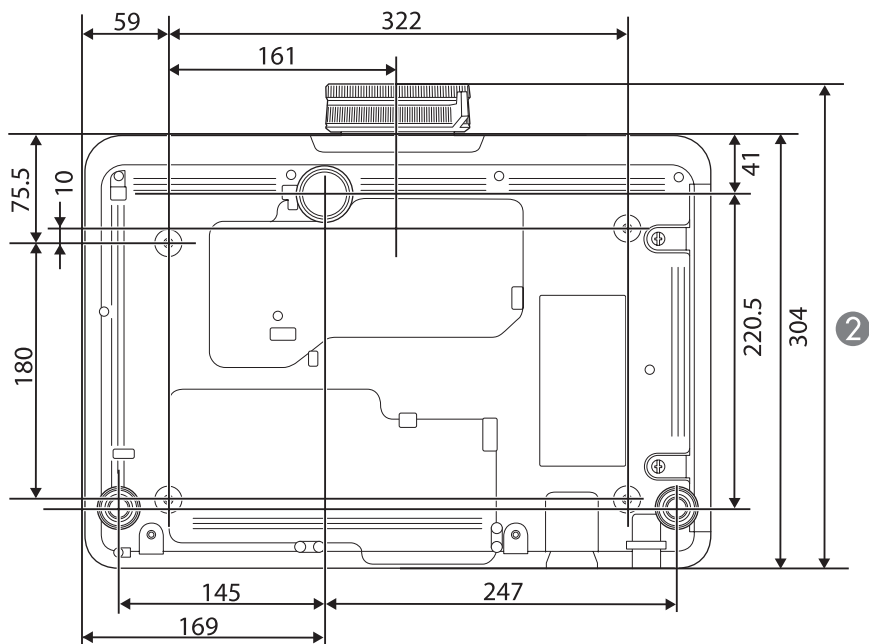

② EB-L615U/EB-L610U/EB-L510U/EB-L610W/EB-L610/EB-L400U: 339 mm

EB-L500W/EB-L500: 320 mm