



EasyMP Network Projection Operation Guide

Introduction to EasyMP Network Projection

EasyMP Network Projection Features	5
Display Options	6
Multi-Screen Display Function	6
Movie Sending Mode	6
Presentation Mode	6
Distribution Function	6
Connection Modes	8
Quick Connection Mode	8
Advanced Connection Mode	8

Setting Up EasyMP Network Projection for the First Time

Installing the Software	10
EasyMP Network Projection System Requirements	10
Installing EasyMP Network Projection (Windows)	11
Installing EasyMP Network Projection (Mac OS X)	11
Setting Up the Projector	12
Connection Methods for Various Network Environments	12
Setting Up a Projector to Connect in Quick Connection Mode	13
Setting Up a Projector to Connect in Advanced Connection Mode (Wireless)	14
Setting Up a Projector to Connect in Advanced Connection Mode (Wired)	15

Connecting to the Projector and Projecting Images

Connection Methods	17
Connecting the Projector and a Computer Directly Using Wireless Communication . . .	17
Connecting the Projector and a Computer over a Network System (Wireless)	19
Connecting the Projector and a Computer over a Network System (Wired)	20

Selecting the Projector Search Method

Search Methods	23
Searching for Network Projectors Automatically	23
Searching for Network Projectors by Specifying an SSID, IP Address, or Projector Name	24
Searching for Network Projectors Using a Profile	25
Profiles for Search	25
Performing a Profile Search	25
Making a Profile	26
Managing a Profile	27

Controlling the Projected Display

Hiding Computer Operations	30
Switching the Input Source	30

Finishing Projecting Images

Using Additional Functions

Changing the Computer Projection Source

Projecting Only a PowerPoint Slide Show

Projecting Movies

Supported Movie Files	36
Using Movie Sending Mode	36

Projecting Images Using the Multi-Screen Display Function . . .

Multi-Screen Display Examples	39
Setting Up Multi-Screen Display	40
Enabling the Virtual Display Driver (Windows)	40
Arranging the Multi-Screen Display (Windows)	41
Arranging the Multi-Screen Display (Mac OS X)	43
Projecting Images to the Arranged Multi-Screen Display	45

Projecting One Computer Screen from Multiple Projectors



Solving Problems

Solving Network Connection Problems	49
Solutions When You Cannot Connect Using Quick Connection Mode	49
Solutions When You Cannot Connect Projectors Using Advanced Connection Mode (Wireless)	50
Solutions When You Cannot Connect Projectors Using Advanced Connection Mode (Wired)	51
Solving Problems During Projection	53
Solutions When the Computer Screen is Not Displayed Properly	53
Solutions When the Screen is Not Projected Properly	53
Solutions When Audio is Not Played Properly	54
Error Messages List	55
Error Messages when Starting up EasyMP Network Projection	55
Error Messages when Searching for and Selecting Projectors	56
Error Messages when Projecting	56
Event ID List	58
Screen Summary	
<hr/>	
Select Connection Mode Screen	60
Search and Connect Screen	61
Profiles	64
Save in the profile	64
Edit profile	64
Set options	66
Set options - General settings	66
Set options - Adjust performance	67
Set options - Audio Output	68
Toolbar	70
Select target projector	71

Projector control	71
Movie Sending Mode	73
Add-Remove Virtual Display	74

Appendix

Updating and Uninstalling the Software	76
Getting the Latest Version of the Application	76
Uninstalling EasyMP Network Projection (Windows XP/Windows Vista/Windows 7) ..	76
Uninstalling EasyMP Network Projection (Windows 8)	76
Uninstalling EasyMP Network Projection (Mac OS X)	77
Supported Resolutions and Colors	78
Supported Resolutions	78
Display Color	78
Limitations	79
Connection Limitations	79
Limitations when Projecting from Windows Photo Gallery or Windows Live Photo Gallery	79
Limitations in Windows Aero	79
Limitations when Projecting from Windows Media Center	80
Notices	81
Copyright Notice	81
About Notations	81
General Notice	81



Introduction to EasyMP Network Projection

See the information here to learn more about EasyMP Network Projection software.

Related Links

- "EasyMP Network Projection Features" [p.5](#)
- "Display Options" [p.6](#)
- "Connection Modes" [p.8](#)

You can use EasyMP Network Projection software to project images from your computer to the projector over a network. Sharing the projector over a network allows you to project images from different computers without having to change cable connections, as well as project images from a remote location.

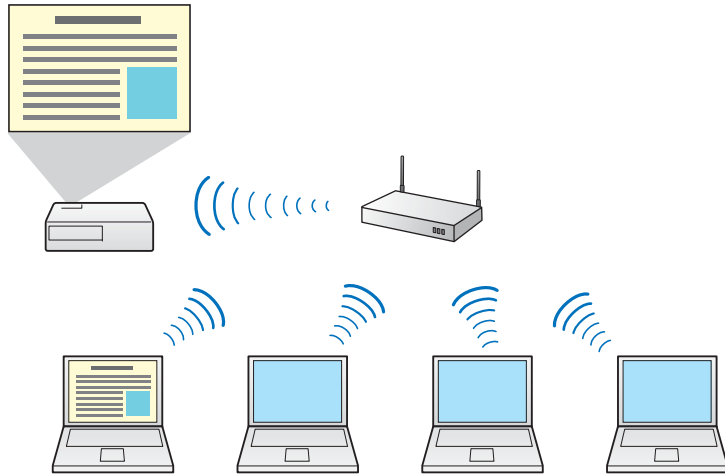

Related Links

- ["Introduction to EasyMP Network Projection" p.4](#)

You can use a variety of display options for projecting images.

Related Links

- "Introduction to EasyMP Network Projection" [p.4](#)
- "Multi-Screen Display Function" [p.6](#)
- "Movie Sending Mode" [p.6](#)
- "Presentation Mode" [p.6](#)
- "Distribution Function" [p.6](#)

Multi-Screen Display Function

You can project different images from up to four projectors that are connected to one computer. This allows you to project complex data, such as a business report, in an extra-wide landscape format.

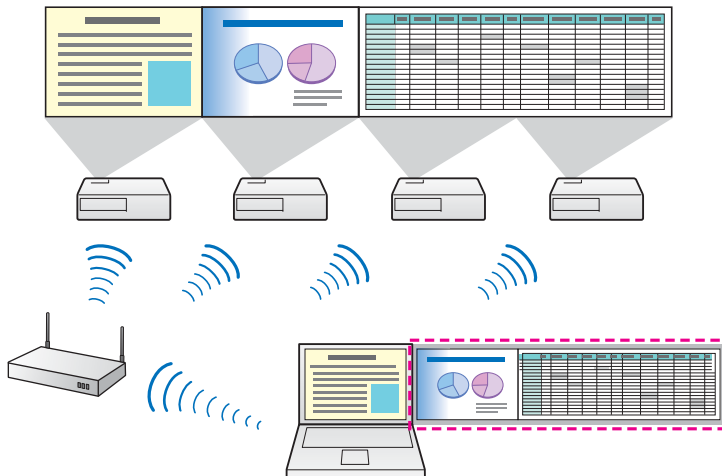

Related Links

- "Display Options" [p.6](#)
- "Projecting Images Using the Multi-Screen Display Function" [p.39](#)

Movie Sending Mode

You can play movies smoothly by sending movie files directly to the projector.



This function is only available for supported models.

Related Links

- "Display Options" [p.6](#)
- "Projecting Movies" [p.36](#)

Presentation Mode

You can project a PowerPoint slide show from your computer without displaying any other distracting computer content. While using Presentation Mode, a black screen is projected when the PowerPoint slide show is not playing.

Related Links

- "Display Options" [p.6](#)
- "Projecting Only a PowerPoint Slide Show" [p.35](#)

Distribution Function

You can project the same computer image simultaneously from up to four projectors connected to the same network.

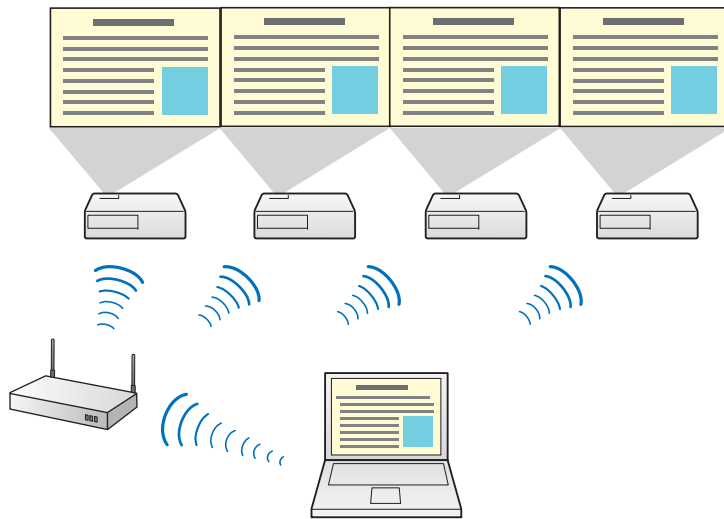

You cannot connect multiple networked computers to one projector at the same time.

Related Links

- "Display Options" [p.6](#)
- "Projecting One Computer Screen from Multiple Projectors" [p.47](#)

You can use the following methods to connect a computer to a projector over a network by using EasyMP Network Projection.

Related Links

- "Introduction to EasyMP Network Projection" [p.4](#)
- "Quick Connection Mode" [p.8](#)
- "Advanced Connection Mode" [p.8](#)

Quick Connection Mode

You can connect the projector and the computer directly using wireless communication. This allows you to project the computer screen without making any complicated network settings.

Quick Connection Mode is only available when you install the wireless LAN unit on the projector.

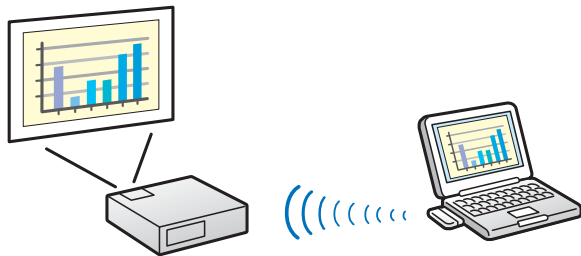

Related Links

- "Connection Modes" [p.8](#)
- "Setting Up a Projector to Connect in Quick Connection Mode" [p.13](#)
- "Connecting the Projector and a Computer Directly Using Wireless Communication" [p.17](#)

Advanced Connection Mode

You can connect the projector and the computer using an existing network system. To use Advanced Connection Mode, you need to connect the projector to an access point or to a network hub.

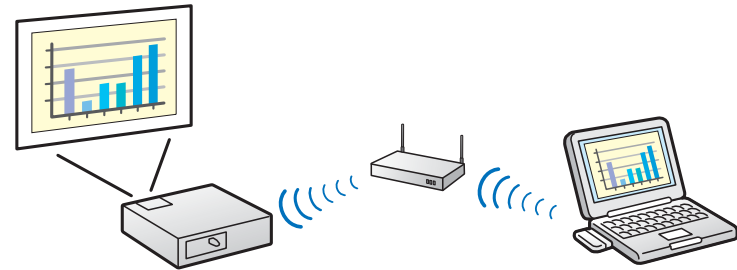

Related Links

- "Connection Modes" [p.8](#)
- "Setting Up a Projector to Connect in Advanced Connection Mode (Wireless)" [p.14](#)
- "Setting Up a Projector to Connect in Advanced Connection Mode (Wired)" [p.15](#)
- "Connecting the Projector and a Computer over a Network System (Wireless)" [p.19](#)
- "Connecting the Projector and a Computer over a Network System (Wired)" [p.20](#)



Setting Up EasyMP Network Projection for the First Time

Follow these instructions before connecting a computer to the projector over a network.

Related Links

- "Installing the Software" [p.10](#)
- "Setting Up the Projector" [p.12](#)

Install EasyMP Network Projection from the EPSON Projector Software CD-ROM supplied with your projector.



- If the language selected for the installation differs from the language of the operating system being used, the screens may not be displayed correctly.
- You can download the latest version of EasyMP Network Projection from the EPSON Web site.
- If a previous version of EasyMP Network Projection is already installed on your computer, uninstall it first and then install EasyMP Network Projection.

Related Links

- "Setting Up EasyMP Network Projection for the First Time" [p.9](#)
- "EasyMP Network Projection System Requirements" [p.10](#)
- "Installing EasyMP Network Projection (Windows)" [p.11](#)
- "Installing EasyMP Network Projection (Mac OS X)" [p.11](#)
- "Getting the Latest Version of the Application" [p.76](#)

EasyMP Network Projection System Requirements

Your computer must meet the following system requirements to use the EasyMP Network Projection software.

Requirement	Windows	Mac
Operating system	Windows XP <ul style="list-style-type: none"> • Professional (32-bit) • Home Edition (32-bit) • Tablet PC Edition (32-bit) 	Mac OS X <ul style="list-style-type: none"> • 10.4.x (32-bit) • 10.5.1 or later (32-bit) • 10.6.x (32- and 64-bit) • 10.7.x (32- and 64-bit) • 10.8.x (64-bit) (Mac OS X 10.4.11, 10.5.8, 10.6.8, 10.7.3, or 10.8.0 recommended)

Requirement	Windows	Mac
	Windows Vista <ul style="list-style-type: none"> • Ultimate (32-bit) • Enterprise (32-bit) • Business (32-bit) • Home Premium (32-bit) • Home Basic (32-bit) 	
	Windows 7 <ul style="list-style-type: none"> • Ultimate (32- and 64-bit) • Enterprise (32- and 64-bit) • Professional (32- and 64-bit) • Home Premium (32- and 64-bit) • Home Basic (32-bit) • Starter (32-bit) 	
	Windows 8 <ul style="list-style-type: none"> • Windows 8 (32- and 64-bit) • Windows 8 Pro (32- and 64-bit) • Windows 8 Enterprise (32- and 64-bit) 	
CPU	Mobile Pentium III 1.2 GHz or faster (Pentium M 1.6 GHz or faster recommended)	Power PC G3 900 MHz or faster (CoreDuo 1.83 GHz or faster recommended)
Memory	256 MB or more (512 MB or more recommended)	
Hard disk space	20 MB or more	
Display	Resolution between 1024 × 768 (XGA) and 1920 × 1200 (WUXGA) 16-bit color or greater (approximately 32,000 display colors)	



- Operation is not guaranteed for Windows XP without any service packs installed, or Windows XP Service Pack 1.
- Operation is not guaranteed for Mac OS X 10.5.0 because the Firewall settings are not set correctly when the version is updated.

Related Links

- "Installing the Software" [p.10](#)

Installing EasyMP Network Projection (Windows)

Install EasyMP Network Projection on your computer.



You need administrator authority to install the software.

- 1** Turn on your computer.
- 2** Make sure all running applications are closed.
- 3** Insert the EPSON Projector Software CD-ROM into the computer. The installer starts automatically.
- 4** If the installer does not start automatically, open the CD-ROM drive from **My Computer** (or **Computer**), and then double-click **InstallNavi.exe** or **EMP_NSCInst.exe**.
- 5** Follow the on-screen instructions to install.

Related Links

- "Installing the Software" [p.10](#)

Installing EasyMP Network Projection (Mac OS X)

Install EasyMP Network Projection on your computer.

- 1** Turn on your computer.
- 2** Make sure all running applications are closed.
- 3** Insert the EPSON Projector Software CD-ROM into the computer.
- 4** Double-click the **EMP_NPInstaller.mpkg** icon in the EPSON window. Installation starts.
- 5** Follow the on-screen instructions to install.

Related Links

- "Installing the Software" [p.10](#)

Follow these instructions to select a connection method between a computer and the projector, and then set up the projector.

Related Links

- "Setting Up EasyMP Network Projection for the First Time" [p.9](#)
- "Connection Methods for Various Network Environments" [p.12](#)
- "Setting Up a Projector to Connect in Quick Connection Mode" [p.13](#)
- "Setting Up a Projector to Connect in Advanced Connection Mode (Wireless)" [p.14](#)
- "Setting Up a Projector to Connect in Advanced Connection Mode (Wired)" [p.15](#)

Connection Methods for Various Network Environments

You can choose a connection mode to suit your network environment.

Check how the projector is connected to the network system (wireless or wired) and the communication path from the computer to the projector.

Depending on your projector, some connection methods may not be available. See the *User's Guide* supplied with the projector for more details.

- To connect the projector to the computer directly using wireless communication:
Use **Quick Connection Mode**.



- To connect the projector to the computer using a wireless network system:
Use **Advanced Connection Mode**.

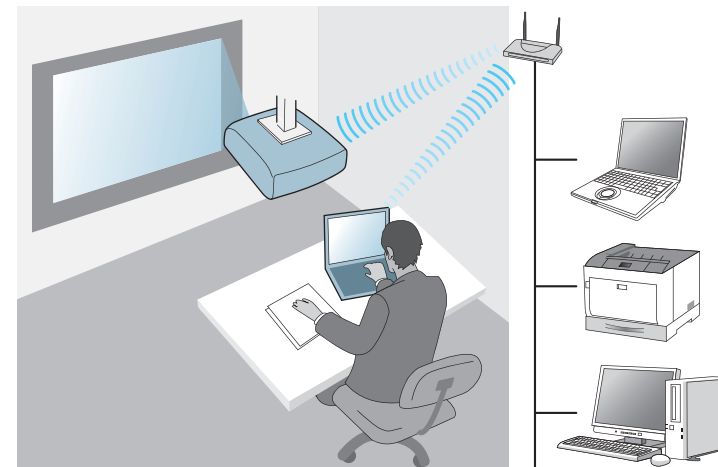

- To connect the projector to the computer using a wired network system:
Use **Advanced Connection Mode**.

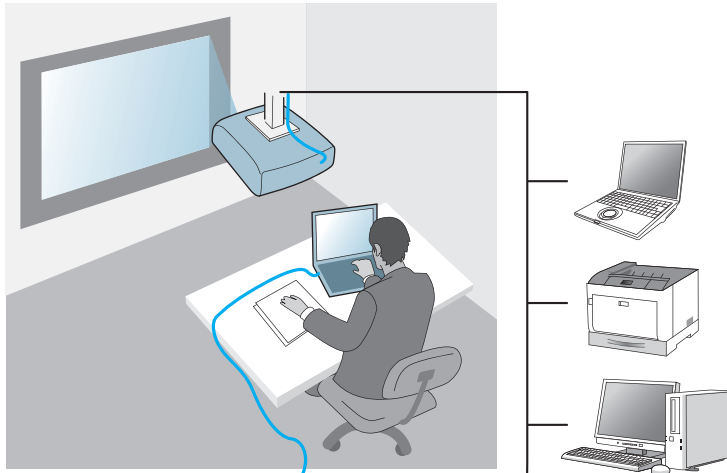

Related Links

- "Setting Up the Projector" [p.12](#)
- "Setting Up a Projector to Connect in Quick Connection Mode" [p.13](#)
- "Setting Up a Projector to Connect in Advanced Connection Mode (Wireless)" [p.14](#)
- "Setting Up a Projector to Connect in Advanced Connection Mode (Wired)" [p.15](#)

Setting Up a Projector to Connect in Quick Connection Mode

To connect a computer directly to the projector using wireless communication, you need to select network settings on the computer and the projector.

- Select the necessary settings to connect your computer to a wireless LAN. See the documentation supplied with your computer for more details.
- Install the wireless LAN unit in the projector, if necessary. See the *User's Guide* supplied with the projector for more details.
- Turn on the projector.
- Press the [Menu] button on the remote control or the control panel, select the **Network** menu, and select **Network Configuration**.
- Select **Wireless LAN**.
A screen like one of the following is displayed.



- Select **On** for **Wireless LAN Power**.
- Select **Quick** for **Connection Mode**.
- Select other options as necessary for your network. See the *User's Guide* supplied with the projector for more details.
- Select security settings on the **Security** menu as necessary for your network. Check with your network administrator for more information on making the correct settings.

- When you have finished making settings, select **Setup Complete** or **Complete** and follow the on-screen instructions to save your settings and exit the menus.

Related Links

- "Setting Up the Projector" [p.12](#)
- "Connecting the Projector and a Computer Directly Using Wireless Communication" [p.17](#)

Setting Up a Projector to Connect in Advanced Connection Mode (Wireless)

To connect a computer to the projector over a wireless LAN, you need to select network settings on the computer and the projector.

- Contact your network administrator and write down the settings for the access point, such as the SSID and security settings.
- Connect the computer to the network.



To set up a network connection, if necessary, see the documentation supplied with your computer or network adapter.

- Install the wireless LAN unit in the projector, if necessary. See the *User's Guide* supplied with the projector for more details.
- Turn on the projector.
- Press the [Menu] button on the remote control or the control panel, select the **Network** menu, and then select **Network Configuration**.

- Select **Wireless LAN**.

A screen like one of the following is displayed.



- Select **On** for **Wireless LAN Power**.

- Select **Advanced** for **Connection Mode**.

- Select other options as necessary for your network. See the *User's Guide* supplied with the projector for more details.

- Select security settings on the **Security** menu as necessary for your network. Check with your network administrator for more information on making the correct settings.

- When you have finished making settings, select **Setup Complete** or **Complete**, and follow the on-screen instructions to save your settings and exit the menus.

Related Links

- "Setting Up the Projector" [p.12](#)
- "Connecting the Projector and a Computer over a Network System (Wireless)" [p.19](#)

Setting Up a Projector to Connect in Advanced Connection Mode (Wired)

To connect a computer to the projector using a wired LAN, you need to select network settings on the computer and the projector.

- 1 Contact your network administrator and check that DHCP is available under the current network environment.



If DHCP is not available, write down the following values that are available for your projector.

- IP Address
- Subnet Mask
- Gateway Address

- 2 Connect the computer to the network.



To set up a network connection, if necessary, see the documentation supplied with your computer or network adapter.

- 3 Connect a LAN cable to the projector.
- 4 Turn on the projector.
- 5 Press the [Menu] button on the remote control or the control panel, select the **Network** menu, and select **Network Configuration**.

- 6 Select **Wired LAN**.
A screen like one of the following is displayed.



- 7 Select IP settings as necessary.
 - DHCP is available: Set **DHCP** to **On**.
 - DHCP is not available: Set **DHCP** to **Off** and enter the projector's IP Address, Subnet Mask, and Gateway Address values as necessary.
- 8 When you have finished making settings, select **Setup Complete** or **Complete**, and follow the on-screen instructions to save your settings and exit the menus.

Related Links

- "Setting Up the Projector" [p.12](#)
- "Connecting the Projector and a Computer over a Network System (Wired)" [p.20](#)



Connecting to the Projector and Projecting Images

Follow these instructions to connect the computer and the projector over a network, and to project images from your computer's screen using the projector. Make sure you have already set up EasyMP Network Projection and selected a connection mode for the projector.

Related Links

- ["Connection Methods" p.17](#)
- ["Selecting the Projector Search Method" p.23](#)
- ["Controlling the Projected Display" p.30](#)
- ["Finishing Projecting Images" p.32](#)
- ["Installing the Software" p.10](#)
- ["Setting Up the Projector" p.12](#)

You can select a suitable method to connect the computer and the projector over a network depending on your network environment.

Related Links

- "Connecting to the Projector and Projecting Images" [p.16](#)
- "Connecting the Projector and a Computer Directly Using Wireless Communication" [p.17](#)
- "Connecting the Projector and a Computer over a Network System (Wireless)" [p.19](#)
- "Connecting the Projector and a Computer over a Network System (Wired)" [p.20](#)

Connecting the Projector and a Computer Directly Using Wireless Communication

When your projector is set up as indicated below, you can connect the projector and a computer directly using wireless communication to project the computer's screen.

- The wireless LAN unit is installed in the projector.
- The projector's connection method is set to **Quick**.



- When you connect the projector and a computer directly using wireless communication, the connection between the computer and an access point is disconnected.
- Make sure you turn on your computer's wireless communication function.

- 1** Press the [LAN] button on the remote control.
The LAN standby screen is projected.

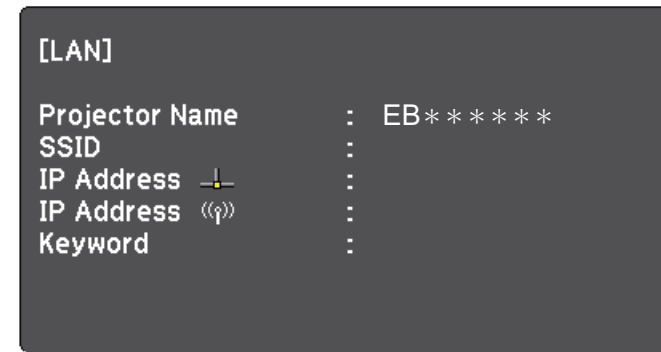

- 2** Start EasyMP Network Projection.
 - Windows XP, Windows Vista, and Windows 7: Click **Start**, select **Programs** (or **All Programs**), **EPSON Projector**, **EasyMP Network Projection**, and then click **EasyMP Network Projection Ver.X.XX**.
 - Windows 8: Select **Search** on the Charms, and then select **EasyMP Network Projection Ver.X.XX**.
 - Mac OS X: Double-click **EasyMP Network Projection** from the **Applications** folder.
- 3** Select **Quick Connection Mode**, and then click **OK**.

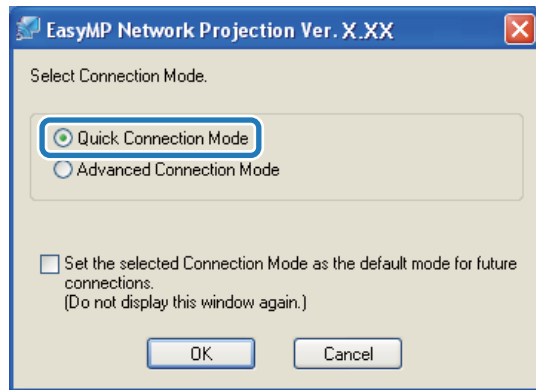

The projector search results are displayed.

4 If the projector you want to connect to is not displayed in the search results, search for it using one of the following methods.

- **Automatic Search:** Searches for the projector automatically.
- **Manual Search:** Searches for the projector based on the SSID selected from a list.
- **Profile:** Searches for the projector based on a previously saved profile.

5 Select the projector you want to connect to, and then click **Connect**.

When Projector Keyword is set to **On** from the projector, the keyword entry screen is displayed.

6 Enter the projector keyword and passphrase.

- Windows XP and Mac OS X: Enter the keyword displayed on the LAN standby screen, and then click **OK**.

- Windows Vista, Windows 7, and Windows 8: Enter the keyword displayed on the LAN standby screen, and then click **OK**. When the following dialog box is displayed, enter the passphrase set on the projector, and then click **Connect**.

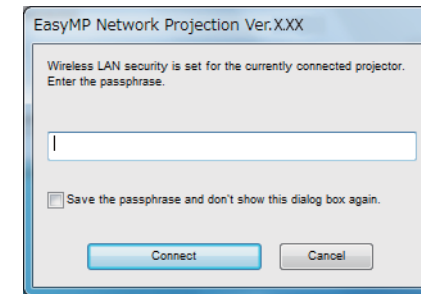

If you select **Save the passphrase and don't show this dialog box again**, the projector's SSID and passphrase are saved on the computer and this dialog box is not displayed the next time you connect. You do not have to enter the passphrase again.

If the projector's passphrase has not been changed from the default, the following dialog box is displayed. Change the passphrase from the projector's **Network** menu.

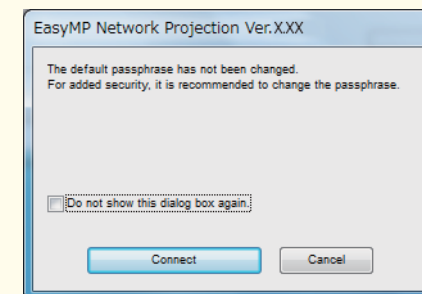

When a connection is established, the computer screen is projected. The following EasyMP Network Projection toolbar is displayed on the computer screen.



When a connection is established, the input source for the projector automatically switches to the LAN source if no other signal is being input. If the input source does not automatically switch to the LAN source, press the [LAN] button.

Related Links

- "Connection Methods" [p.17](#)
- "Setting Up a Projector to Connect in Quick Connection Mode" [p.13](#)
- "Searching for Network Projectors Automatically" [p.23](#)
- "Searching for Network Projectors by Specifying an SSID, IP Address, or Projector Name" [p.24](#)
- "Performing a Profile Search" [p.25](#)

Connecting the Projector and a Computer over a Network System (Wireless)

When your projector is set up as indicated below, you can connect the projector to an existing network system and project the computer's screen over the network.

- The wireless LAN unit is installed in the projector.
- The projector's connection method is set to **Advanced**.



Make sure you connect a computer to the network.

- 1 Press the [LAN] button on the remote control.
The LAN standby screen is projected.

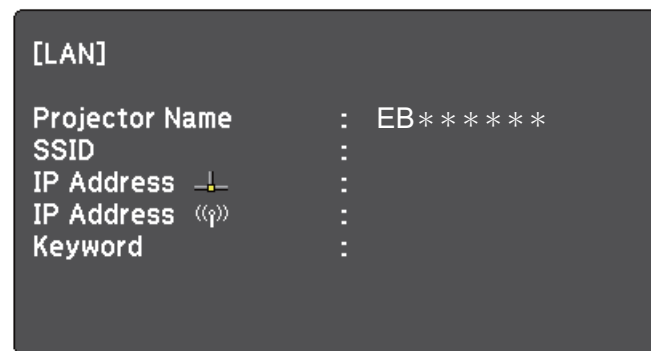

- 2 Start EasyMP Network Projection.
 - Windows XP, Windows Vista, and Windows 7: Click **Start**, select **Programs** (or **All Programs**), **EPSON Projector**, **EasyMP Network Projection**, and then click **EasyMP Network Projection Ver.X.XX**.
 - Windows 8: Select **Search** on the Charms, and then select **EasyMP Network Projection Ver.X.XX**.
 - Mac OS X: Double-click **EasyMP Network Projection** from the **Applications** folder.
- 3 Select **Advanced Connection Mode**, and then click **OK**.

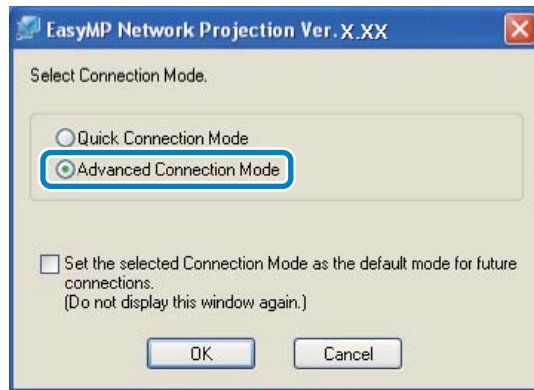

The projector search results are displayed.

4 If the projector you want to connect to is not displayed in the search results, search for it using one of the following methods.

- **Automatic Search:** Searches for the projector automatically.
- **Manual Search:** Searches for the projector based on a specified IP address or projector name.
- **Profile:** Searches for the projector based on a previously saved profile.

5 Select the projector you want to connect to, and then click **Connect**.

When Projector Keyword is set to **On** from the projector, the keyword entry screen is displayed.

6 Enter the keyword displayed on the LAN standby screen, and then click **OK**.

When the connection is complete, the computer screen is projected. The following EasyMP Network Projection toolbar is displayed on the computer screen.



When a connection is established, the input source for the projector automatically switches to the LAN source if no other signal is being input. If the input source does not automatically switch to the LAN source, press the [LAN] button.

Related Links

- "Connection Methods" [p.17](#)
- "Setting Up a Projector to Connect in Advanced Connection Mode (Wireless)" [p.14](#)
- "Searching for Network Projectors Automatically" [p.23](#)
- "Searching for Network Projectors by Specifying an SSID, IP Address, or Projector Name" [p.24](#)
- "Performing a Profile Search" [p.25](#)

Connecting the Projector and a Computer over a Network System (Wired)

When your projector is set up as indicated below, you can connect the projector to an existing network system and project the computer's screen over the network.

- A LAN cable is connected to the projector.
- The projector's connection method is set to **Advanced**.



Make sure you connect a computer to the network.

- 1 Press the [LAN] button on the remote control.
The LAN standby screen is projected.

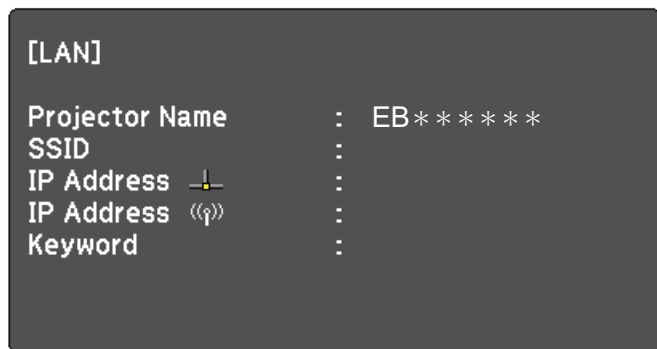

- 2 Start EasyMP Network Projection.

- Windows XP, Windows Vista, and Windows 7: Click **Start**, select **Programs** (or **All Programs**), **EPSON Projector**, **EasyMP Network Projection**, and then click **EasyMP Network Projection Ver.X.XX**.
- Windows 8: Select **Search** on the Charms, and then select **EasyMP Network Projection Ver.X.XX**.
- Mac OS X: Double-click **EasyMP Network Projection** from the **Applications** folder.

- 3 Select **Advanced Connection Mode**, and then click **OK**.

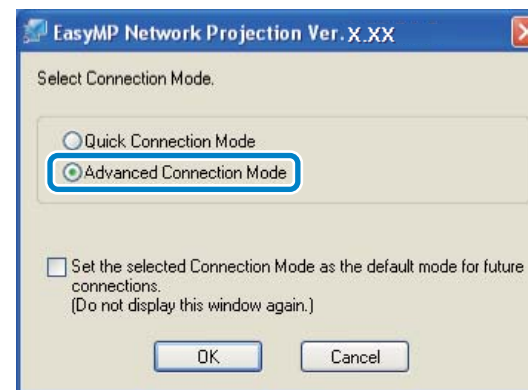

The projector search results are displayed.

- 4 If the projector you want to connect to is not displayed in the search results, search for it using one of the following methods.

- **Automatic Search:** Searches for the projector automatically.
- **Manual Search:** Searches for the projector based on a specified IP address or projector name.
- **Profile:** Searches for the projector based on a previously saved profile.

- 5 Select the projector you want to connect to, and then click **Connect**.

When Projector Keyword is set to **On** from the projector, the keyword entry screen is displayed.

- 6 Enter the keyword displayed on the LAN standby screen, and then click **OK**.

When the connection is complete, the computer screen is projected. The following EasyMP Network Projection toolbar is displayed on the computer screen.



When a connection is established, the input source for the projector automatically switches to the LAN source if no other signal is being input. If the input source does not automatically switch to the LAN source, press the [LAN] button.

Related Links

- "Connection Methods" [p.17](#)
- "Setting Up a Projector to Connect in Advanced Connection Mode (Wired)" [p.15](#)
- "Searching for Network Projectors Automatically" [p.23](#)
- "Searching for Network Projectors by Specifying an SSID, IP Address, or Projector Name" [p.24](#)
- "Performing a Profile Search" [p.25](#)

You can select a suitable method to search for a projector depending on the status or location of the projector you want to connect to.

Related Links

- "Connecting to the Projector and Projecting Images" [p.16](#)
- "Search Methods" [p.23](#)
- "Searching for Network Projectors Automatically" [p.23](#)
- "Searching for Network Projectors by Specifying an SSID, IP Address, or Projector Name" [p.24](#)
- "Searching for Network Projectors Using a Profile" [p.25](#)

Search Methods

You can use one of the following methods to search for the projector you want to connect to. Choose the best method depending on your environment.

- Searching for Network Projectors Automatically
You can automatically search for available projectors on the network. Search results differ depending on the connection mode you use.
 - Quick Connection Mode: Displays the SSID for available projectors.
 - Advanced Connection Mode: Displays available projectors on the network. Searches are performed only on the same subnet. Projectors on different subnets are not displayed in the search results.
- Searching for Network Projectors by Specifying an SSID, IP Address, or Projector Name
If the projector you want to connect to is not found automatically, you can search for the target projector by specifying the SSID, IP address, or a projector name. By using Advanced Connection Mode, you can search for projectors at remote locations on a different subnet.

- Searching for Network Projectors Using a Profile

You can save network projector information as a profile, and then specify the profile to search for the same projector instead of providing projector details each time you search. By creating a group of profiles for each place where a projector is setup and managing them with folders, the target projector can be found quickly.

Related Links

- "Selecting the Projector Search Method" [p.23](#)

Searching for Network Projectors Automatically

You can automatically search for available projectors on the network, and then project images by simply selecting the projector.

Click **Automatic search** on the search and connect screen. The search takes about 30 seconds.

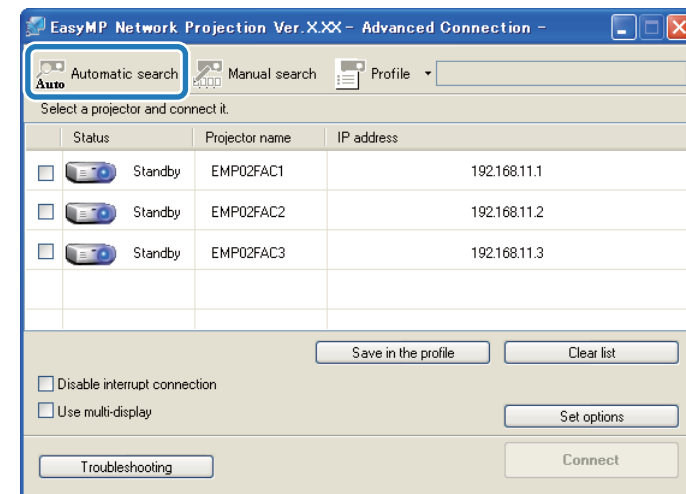

The search results are displayed.

If you cannot find any projectors, try one of the other search methods.

Related Links

- "Selecting the Projector Search Method" [p.23](#)
- "Searching for Network Projectors by Specifying an SSID, IP Address, or Projector Name" [p.24](#)
- "Performing a Profile Search" [p.25](#)
- "Search Methods" [p.23](#)

Searching for Network Projectors by Specifying an SSID, IP Address, or Projector Name

If the projector you want to connect to is not found automatically, you can search for the target projector by specifying the relevant details. In Quick Connection Mode, you can search for the projector by using an SSID. In Advanced Connection Mode, you can search for a projector by using an IP address or a projector name.

- 1 Click **Manual search** on the following screen.

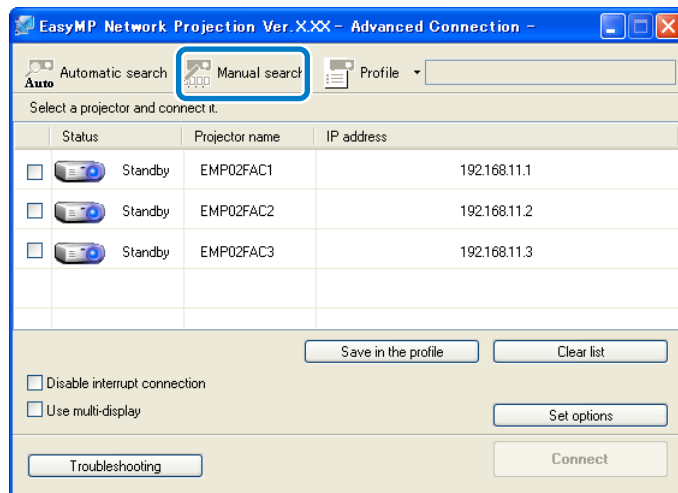

- 2 Specify one of the following items, and then click **OK**.

- Quick Connection Mode: Select the SSID for the projector you want to connect to from the list.

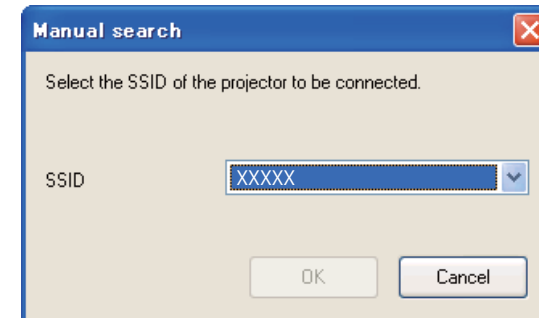

- Advanced Connection Mode: Enter the IP address or the projector name for the projector you want to connect to.

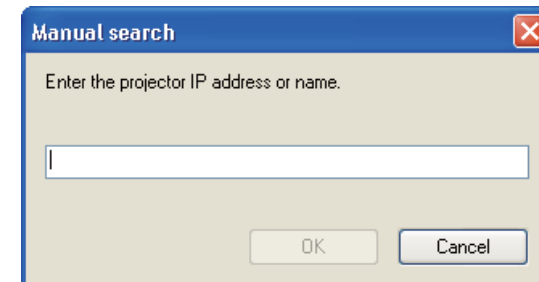

The search results are displayed.

Related Links

- "Selecting the Projector Search Method" [p.23](#)

Searching for Network Projectors Using a Profile

You can save network projector information as a profile, and then search for the same projector using the profile instead of specifying the projector details each time.

Related Links

- "Selecting the Projector Search Method" [p.23](#)
- "Profiles for Search" [p.25](#)
- "Performing a Profile Search" [p.25](#)
- "Making a Profile" [p.26](#)
- "Managing a Profile" [p.27](#)

Profiles for Search

You can save information for a network projector as a profile. A profile is a file containing all of the projector's information, such as the projector name, IP address, and SSID. By using a profile, you can easily search for saved projectors instead of providing projector details.

Related Links

- "Searching for Network Projectors Using a Profile" [p.25](#)

Performing a Profile Search

You can specify the profile to search for the saved projector instead of providing projector details each time you search.

- 1 Click **Profile** on the search and connect screen.

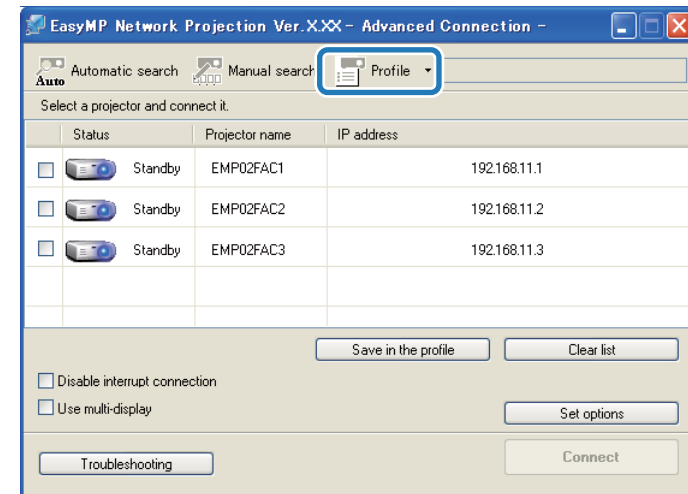

If no profiles are created, you cannot select **Profile**.

- 2 Select the projector you want to connect to from the list.

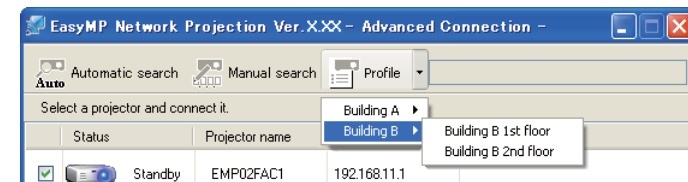

The search results are displayed.

Related Links

- "Searching for Network Projectors Using a Profile" [p.25](#)

Making a Profile

After searching for a projector, you can save the projector details as a profile using a memorable name that you can search for easily later.

- 1 While the projector is displayed on the following screen, click **Save in the profile**.

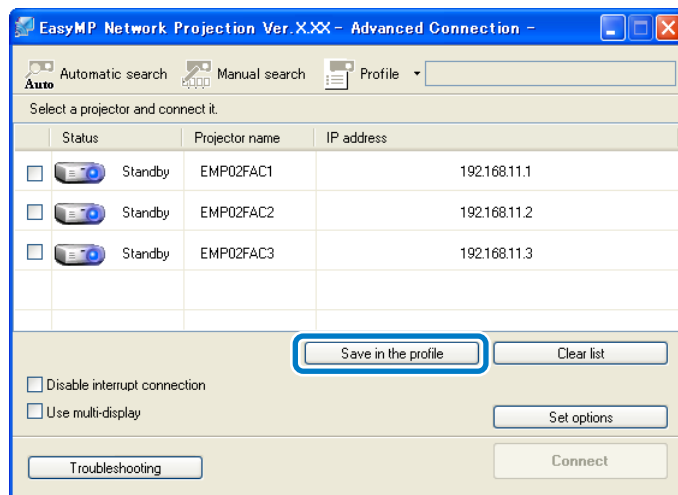

- 2 Enter a Profile name, and then click **Add**.

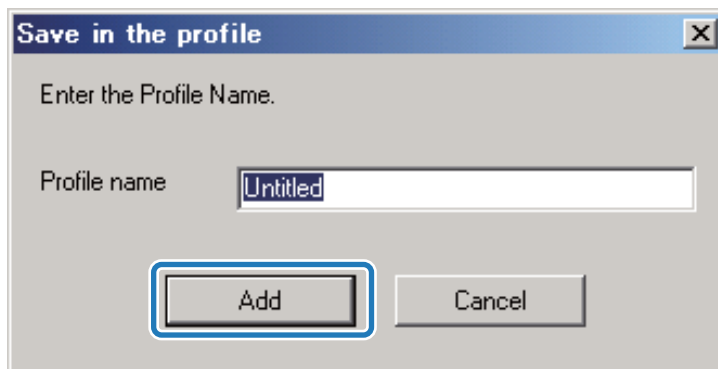

- 3 Perform the following operations as necessary.

- An overwrite confirmation screen is displayed: If you are prompted to confirm whether or not you want to overwrite, select **Save as** to save a profile with a different name.

- A folder selection screen is displayed: If you have created a folder for profiles, one of the following screens is displayed. After entering the Profile name and selecting the **Save in** destination, click **Add**.
Windows:

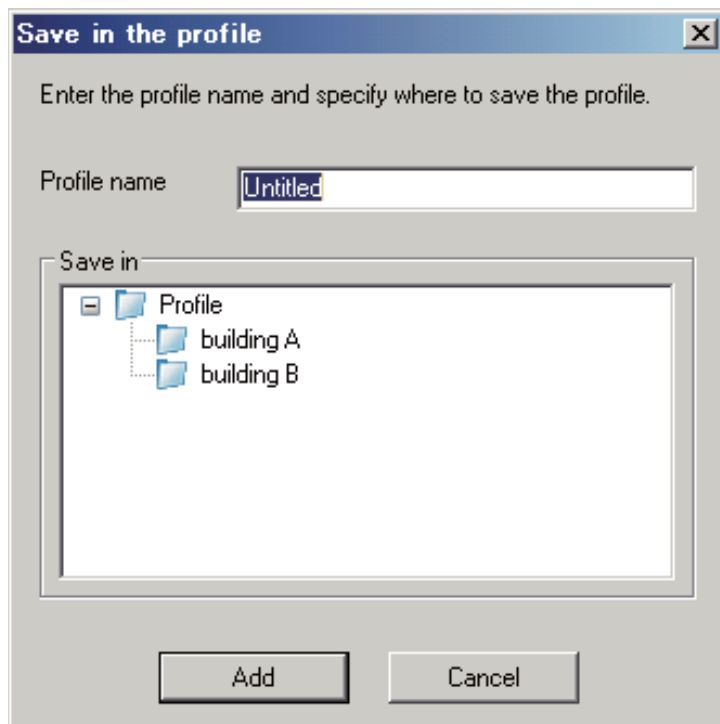

Mac OS X:

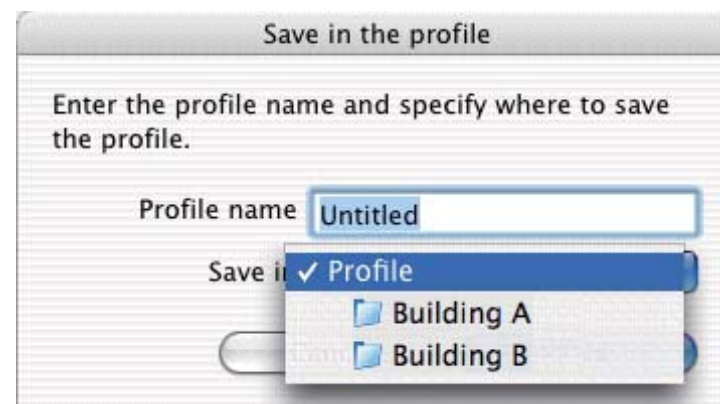

The projector information is saved in the profile.

Related Links

- ["Searching for Network Projectors Using a Profile" p.25](#)

Managing a Profile

You can change the name and the organization of your profiles.

- 1 Click **Set options** on the following screen.

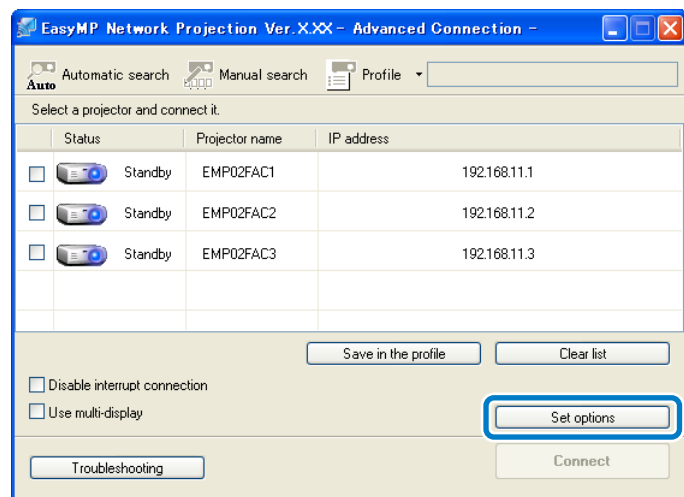

The Set options screen is displayed.

- 2** Click **Edit profile**.

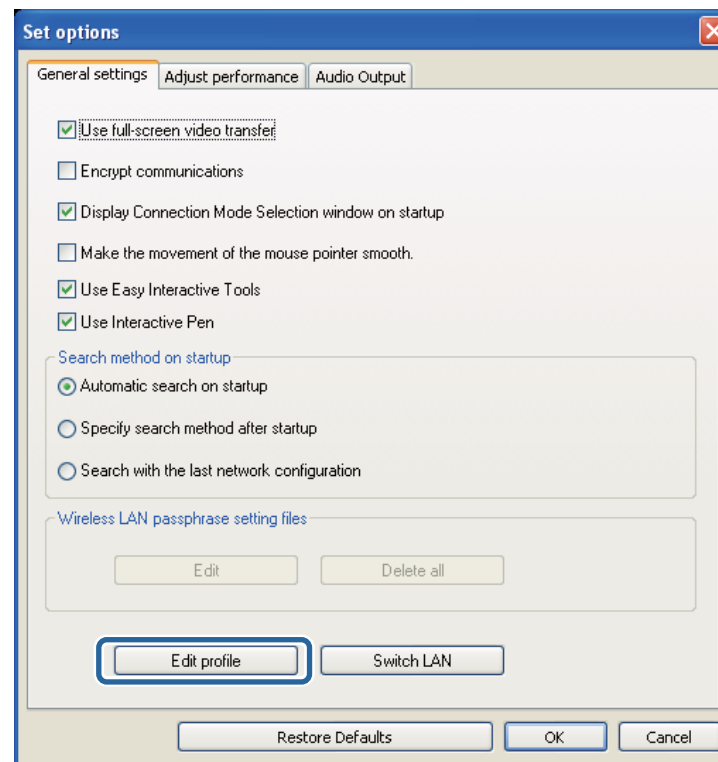

The Edit profile screen is displayed.

- 3** Edit the profiles as necessary.

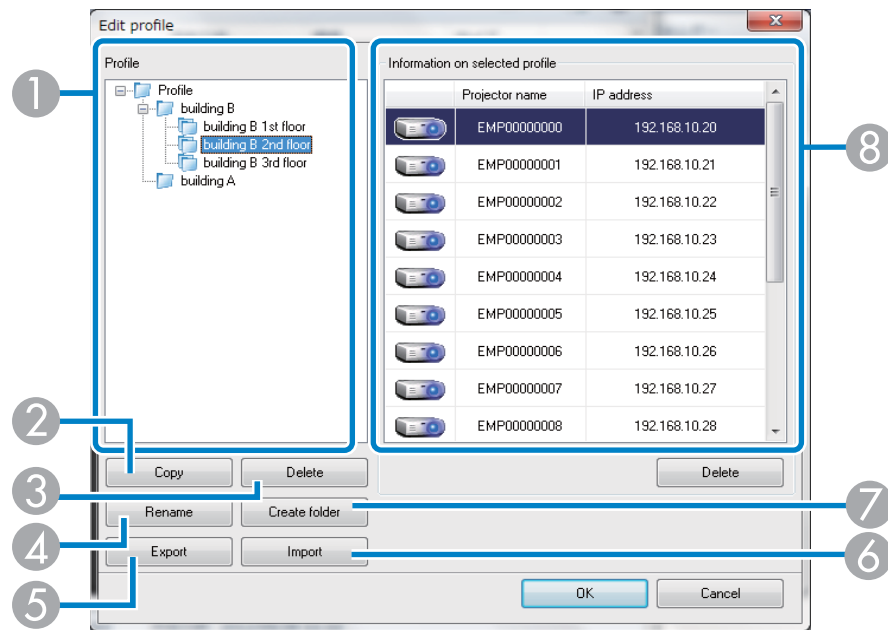

Your edits are saved and the Edit profile screen closes.

Related Links

- ["Searching for Network Projectors Using a Profile" p.25](#)

- ① Displays the profiles. You can drag and drop profiles and folders to change the folder structure.
- ② Duplicates the profile. The copied profile is saved in the same folder as the original with the same name.
- ③ Deletes the profile and the folder.
- ④ Displays the Rename dialog box to rename the folder or the profile. You can enter up to 32 characters in the Rename dialog box.
- ⑤ Exports the profile. Exported profiles can be used as backup files. You can then import them on another computer.
- ⑥ Loads an exported profile.
- ⑦ Creates a new folder.
- ⑧ Displays the projectors saved in the profile. To delete a specific projector from the profile, select the projector and then press the **Delete** button. When all projector information has been deleted, the profile is also deleted.

4 Click **OK**.

Follow these instructions to use the toolbar to control the screen being projected.

Related Links

- "Connecting to the Projector and Projecting Images" [p.16](#)
- "Hiding Computer Operations" [p.30](#)
- "Switching the Input Source" [p.30](#)

Hiding Computer Operations

You can hide your computer operations from your audience while giving a presentation by stopping, pausing, or muting the projection.

- 1 Make sure the toolbar display is set to **Full**.



- 2 If you are connected to multiple projectors, click the  button on the toolbar and select the projector you want to control.

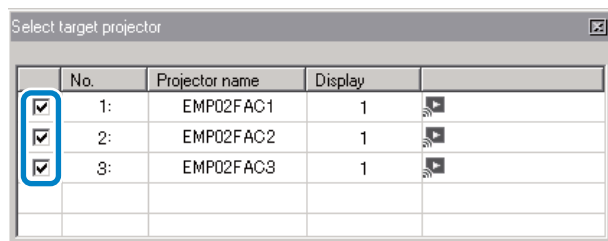

- 3 Perform one of the following operations.

- Stop: Click the  button on the toolbar.

The projected image stops. A black screen is projected while stopped.

- Pause: Click the  button on the toolbar.

The projected image pauses. The paused image is projected.

- A/V Mute: Click the  button on the toolbar, and then click the

 button on the toolbar that is displayed.

The audio and video turn off. The logo set for the projector is projected while using **A/V Mute**, if available.

- 4 To return to the projected image, perform one of the following operations.

- Stop or Pause: Click the  button on the toolbar.

- A/V Mute: Click the  button again.

Related Links

- "Controlling the Projected Display" [p.30](#)

Switching the Input Source

When another signal is being input to the projector while projecting over a network, you can change the input source from the toolbar.

- 1 Make sure the toolbar display is set to **Full**.

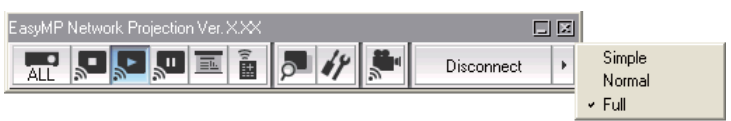



2 If you are connected to multiple projectors, click the  button on the toolbar and select the projector you want to control.

No.	Projector name	Display
<input checked="" type="checkbox"/>	1: EMP02FAC1	1
<input checked="" type="checkbox"/>	2: EMP02FAC2	1
<input checked="" type="checkbox"/>	3: EMP02FAC3	1

3 Click the  button on the toolbar.

4 Perform one of the following operations.

- Switch to a computer source: Click the  button.
- Switch to a video source: Click the  button.

Related Links

- "Controlling the Projected Display" [p.30](#)

You can finish projecting images by using the toolbar.

Click the  button to disconnect.

The computer and the projector are disconnected and the LAN standby screen is projected. The search and connect screen is displayed in EasyMP Network Projection software.

Related Links

- "Connecting to the Projector and Projecting Images" [p.16](#)



Using Additional Functions

Follow these instructions to use additional EasyMP Network Projection functions that may be useful during a meeting or presentation.

Related Links

- "Changing the Computer Projection Source" [p.34](#)
- "Projecting Only a PowerPoint Slide Show" [p.35](#)
- "Projecting Movies" [p.36](#)
- "Projecting Images Using the Multi-Screen Display Function" [p.39](#)
- "Projecting One Computer Screen from Multiple Projectors" [p.47](#)

You can change the computer from which you are projecting which allows you to change presenters during meetings, for example.



If a connection is made while **Disable interrupt connection** is set on the search and connect screen, the connection is not switched to another computer.

- 1** Start EasyMP Network Projection on the computer you want to project from.
- 2** Follow standard procedures to connect the projector and a computer.

The computer that is currently connected is disconnected, and the projector connects to the computer that is currently trying to connect.

Related Links

- "Using Additional Functions" [p.33](#)
- "Connecting the Projector and a Computer Directly Using Wireless Communication" [p.17](#)
- "Connecting the Projector and a Computer over a Network System (Wireless)" [p.19](#)
- "Connecting the Projector and a Computer over a Network System (Wired)" [p.20](#)

By using Presentation Mode, you can project only the PowerPoint slide show running on your computer. You can start presentation without displaying any other distracting computer content. While using Presentation Mode, a black screen is projected when the PowerPoint slide show is not playing.





Presentation Mode also works in Keynote with Mac OS X.

- 1 Make sure the toolbar display is set to **Full**.

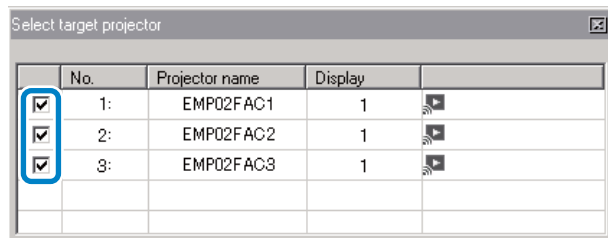

- 2 If you are connected to multiple projectors, click the  button on the toolbar and select the projector you want to control.



- 3 Click the  button on the toolbar.
- 4 Run the PowerPoint slide show on your computer.
The PowerPoint slide show is projected.

- 5 To stop Presentation Mode, click the  button again.

Related Links

- "Using Additional Functions" [p.33](#)

You can project movies smoothly by using Movie Sending Mode.

Related Links

- "Using Additional Functions" [p.33](#)
- "Supported Movie Files" [p.36](#)
- "Using Movie Sending Mode" [p.36](#)

Supported Movie Files

The following movie file types are supported.



You cannot project files protected by digital rights management (DRM).

File Type (Extension)	Movie Codec	Audio Codec	Recording Quality
.mpg .mpeg	MPEG-2	MPEG-1 Layer 1/2 You can play MPEG contents without audio. Linear PCM and AC-3 are not supported.	Maximum frame rate: 30 fps Maximum resolution: 1280 × 720
.mp4	MPEG-4 ASP H.264/MPEG-4 AVC	MPEG-4 AAC-LC	
.wmv .asf	WMV9	WMA	

Related Links

- "Projecting Movies" [p.36](#)

Using Movie Sending Mode

You can send movie files directly to the projector by using Movie Sending Mode. This allows smoother play back of movies than by projecting them from another application on your computer.

You can also select multiple files and play them repeatedly from first to last.



- Some projectors may not support Movie Sending Mode.
- You can use Movie Sending Mode to send a movie to a single projector. You cannot send a movie to multiple projectors at the same time using Movie Sending Mode.
- The image and sound may skip or stop depending on the communication method and electromagnetic wave conditions.

1 Make sure the toolbar display is set to **Full**.



2 Click the  button on the toolbar.

The projector selection screen is displayed.

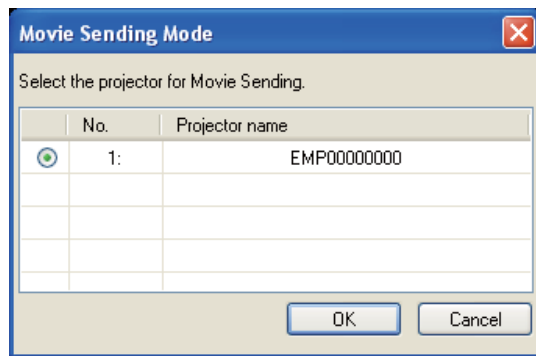

3 Select the projector, and then click **OK**.
The Movie Sending Mode screen is displayed.

4 Click **Select File**.

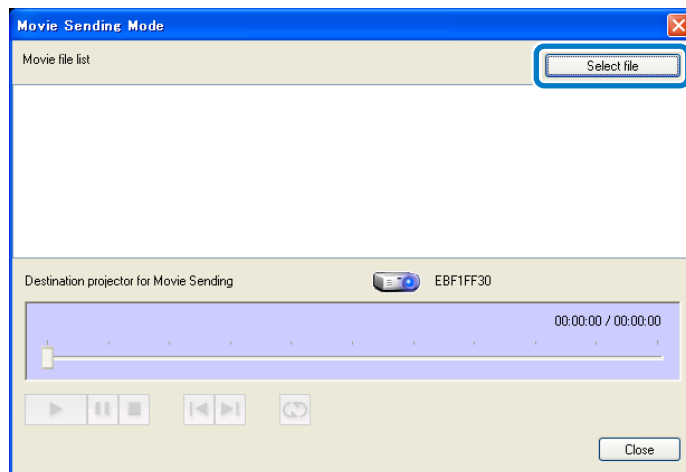

5 Select the movie file you want to play, and then click **Open**.

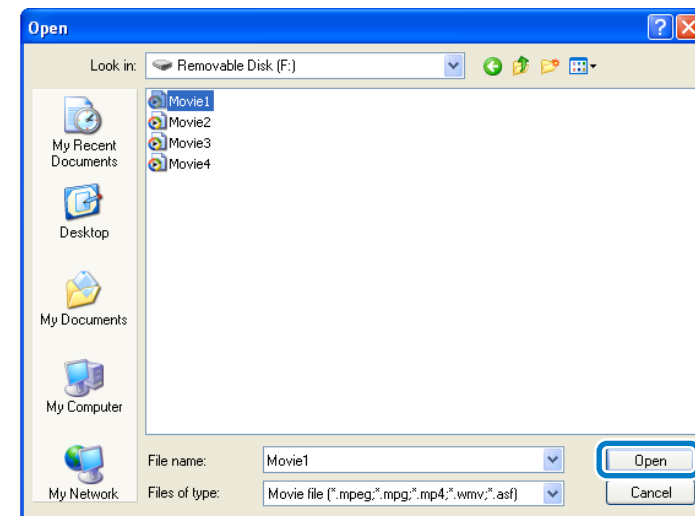

The Movie Sending Mode screen is displayed again. The selected file is displayed in the Movie file list.

If you click **Select file** again, the Movie file list currently displayed is cleared, and then only the files you select later are displayed in the list.

6 Control movie play back using the Movie Sending Mode screen.

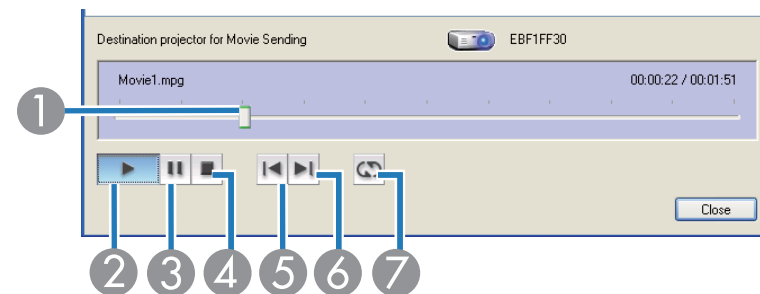

1 Displays the current point in the movie file. You can drag and drop the slider to the point where you want to start playing.

- ② Plays the file.
- ③ Pauses play back.
- ④ Stops play back.
- ⑤ Plays the current file from the beginning.
- ⑥ Plays the next file from the beginning.
- ⑦ Plays repeatedly from the first file in the list. You cannot repeat one specific file when there are multiple files in the list.

7 To exit Movie Sending Mode, click **Close**.

Related Links

- "Projecting Movies" [p.36](#)

By using the multi-screen display function, you can project different images from up to four projectors that are connected to one computer. This allows you to project complex data, such as a business report, in an extra-wide landscape format.

Related Links

- "Using Additional Functions" [p.33](#)
- "Multi-Screen Display Examples" [p.39](#)
- "Setting Up Multi-Screen Display" [p.40](#)

Multi-Screen Display Examples

By using the multi-screen display function, you can project images in the following display arrangements.



- For Windows, you can set virtual display drivers and project each image from the projector. Virtual display drivers are not available for Windows Vista, Windows 7, and Windows 8.
- For Mac OS X, you must connect an external monitor to the computer to use the multi-screen display function.

If you want to project two different images from your computer to two projectors, you can assign the additional display as shown below.

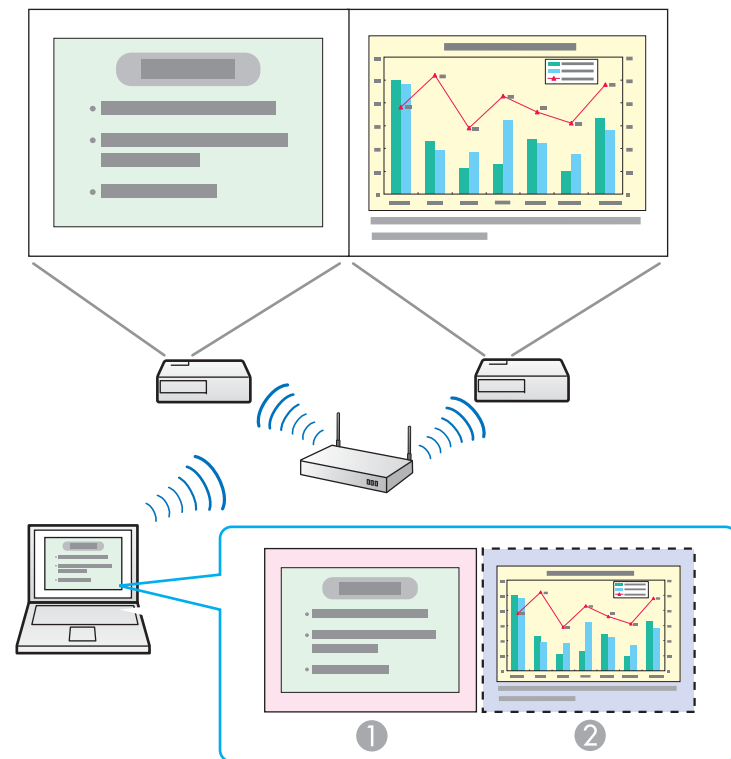

- ① Actual monitor image: PowerPoint file
- ② Additional display image: Excel file

If you want to access two different images or views on your computer but project only one image to the projector, you can assign the additional display as shown below.

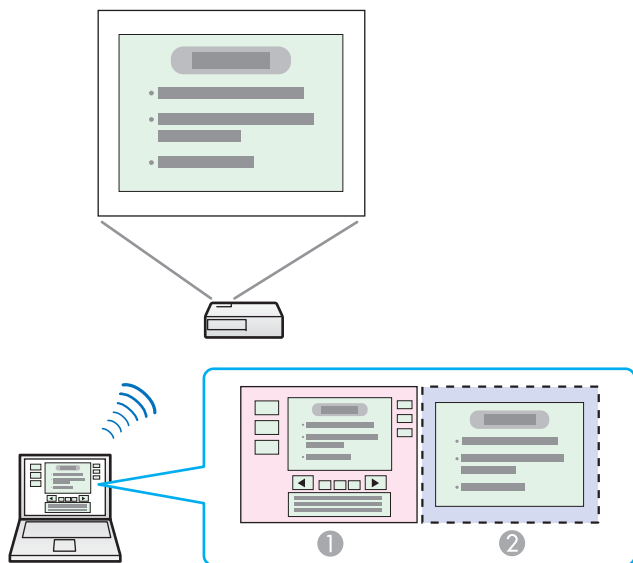

- ① Actual monitor image: PowerPoint file presenter tools
- ② Additional display image: Slide show using a PowerPoint file

Related Links

- "Projecting Images Using the Multi-Screen Display Function" [p.39](#)

Setting Up Multi-Screen Display

Follow these instructions to set up multi-screen display. If you connected an additional external monitor to your computer, you can skip the steps for enabling the virtual display driver.

Related Links

- "Projecting Images Using the Multi-Screen Display Function" [p.39](#)
- "Enabling the Virtual Display Driver (Windows)" [p.40](#)
- "Arranging the Multi-Screen Display (Windows)" [p.41](#)

- "Arranging the Multi-Screen Display (Mac OS X)" [p.43](#)
- "Projecting Images to the Arranged Multi-Screen Display" [p.45](#)

Enabling the Virtual Display Driver (Windows)

Before using the multi-screen display function, you need to enable the virtual display driver for Windows.



If you have already enabled the virtual display while installing EasyMP Network Projection, you do not need to enable it again.

- 1** Click **Start**, select **Programs** (or **All Programs**), **EPSON Projector**, **EasyMP Network Projection**, and then click **Add-Remove Virtual Display**.

The Add-Remove Virtual Display screen is displayed.

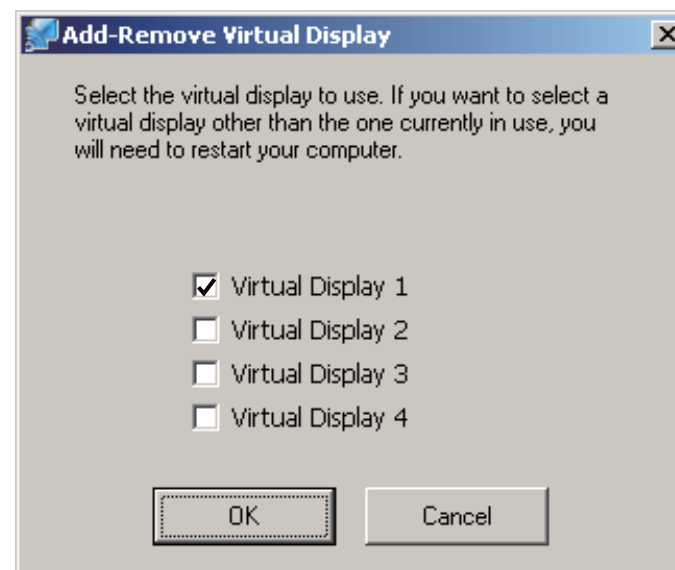

2 Select the virtual display you want to use. When setting multiple virtual displays, select as many displays as necessary. Any one of the displays can be selected.

3 Click **OK**.

The virtual display drivers are enabled and the display may flicker. When the procedure is complete, the Add-Remove Virtual Display screen closes.



If the virtual display driver has been enabled so that the mouse pointer can be moved outside the limits of the screen, there may be occasions when you lose track of the location of the pointer. If you are not using a virtual display, clear the virtual display checkbox on the Add-Remove Virtual Display screen so that the mouse pointer moves back inside the screen's display area. To subsequently use multi-screen display function again, place a check mark next to the required display on the Add-Remove Virtual Display screen.

Related Links

- "Setting Up Multi-Screen Display" p.40

Arranging the Multi-Screen Display (Windows)

You can arrange the position of each display. If you are using a virtual display, enable the virtual display before arranging the multi-display.

1 If you use an external display, connect it to the computer.

2 Check the following items when connecting over a wireless LAN and modify the settings as necessary. If the following items are not set correctly, the multi-screen display function cannot be used.

- The SSID for the computer and each projector must be the same. (For Quick Connection Mode)

- The wireless LAN system for the computer and each projector must be the same.

3 Click **Start**, select **Programs** (or **All Programs**), **EPSON Projector**, **EasyMP Network Projection**, and then click **EasyMP Network Projection V2.XX** to start EasyMP Network Projection.

4 Select **Quick Connection Mode** or **Advanced Connection Mode**, and then click **OK**.



When you connect to multiple projectors to project different images from each projector, select **Advanced Connection Mode**.

5 Select **Use multi-display**.

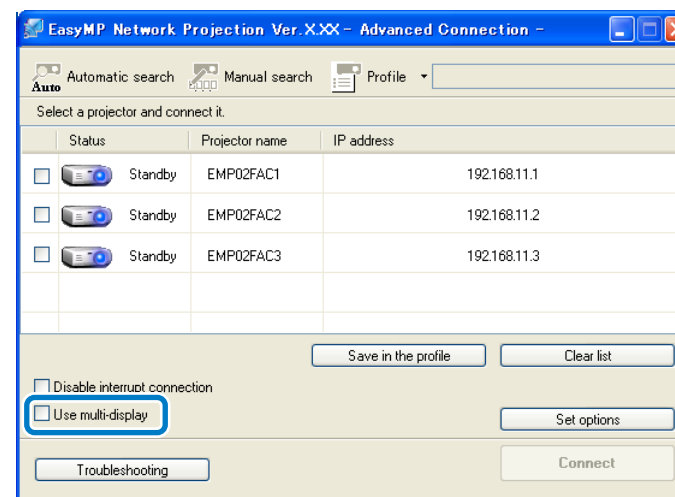

Display layout and **Display properties** options are added at the bottom of the screen.

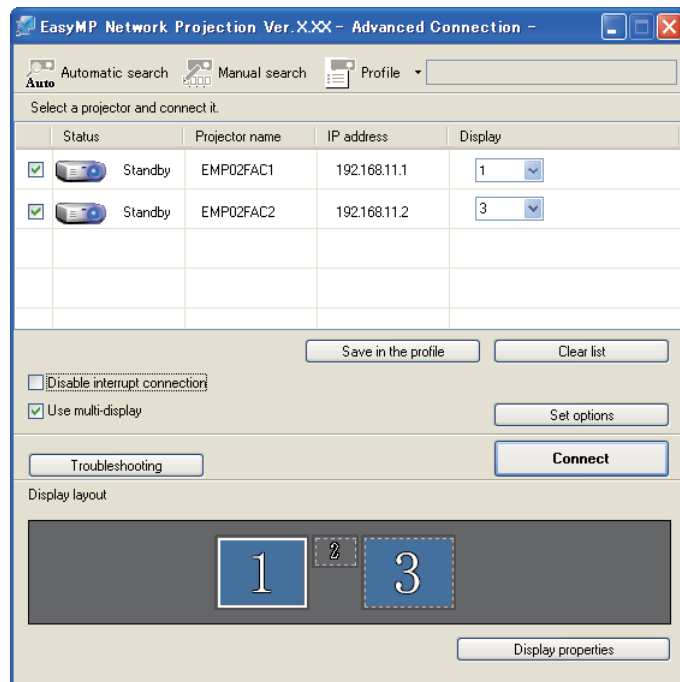

6 Click **Display properties**.

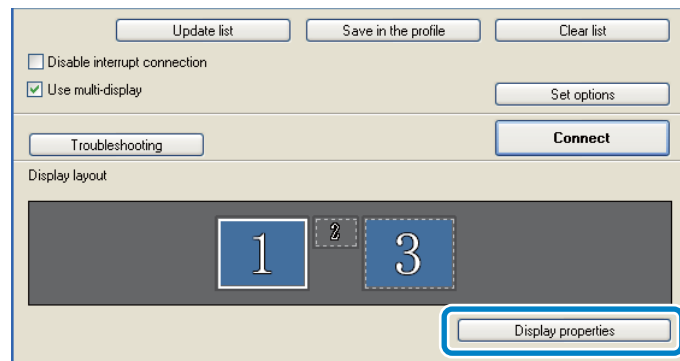

The Display Properties screen is displayed.

7 Click the **Settings** tab.

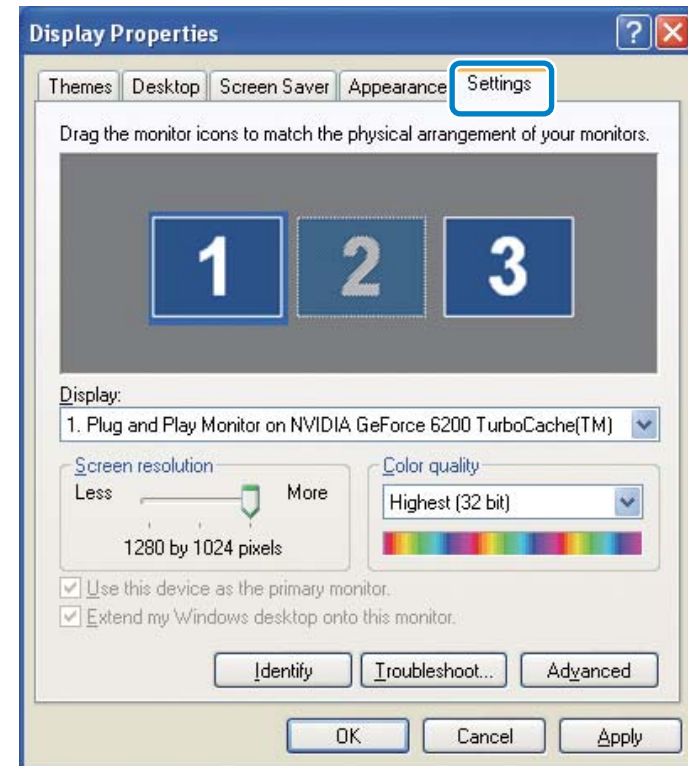

8 Drag the displayed monitor icon and place it where you want the additional image to appear. In the following example, the actual monitor (1) is placed on the left, while the additional monitor (3) is placed on the right.

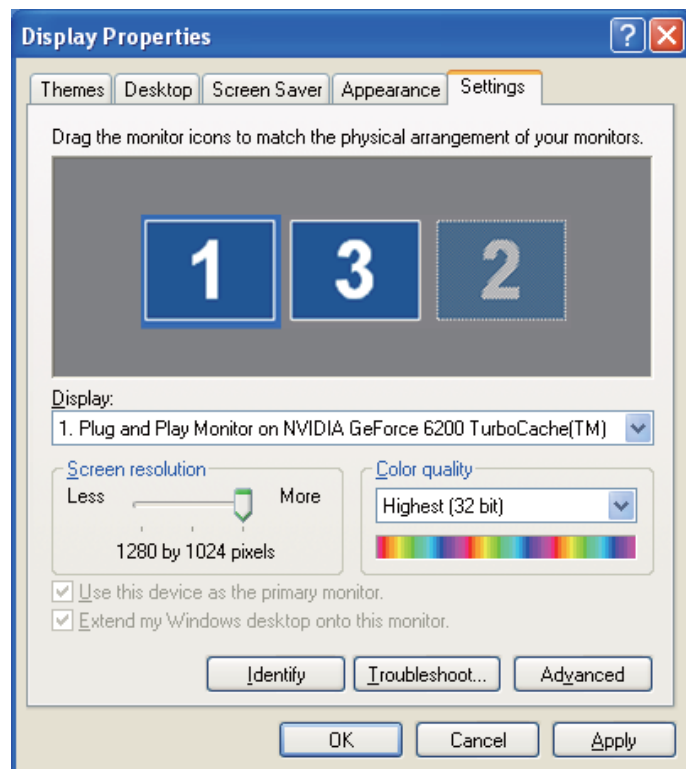

- When the PC has multiple display output terminals, the numbers assigned to the virtual terminals are sequential to those of the physical terminals.
- When an external monitor is connected as a secondary monitor, the image for that screen cannot be projected.
- Depending on the hardware, the number for the secondary monitor may not be "2". When placing the monitor icons, click the icon to check that the display monitor type is not the secondary monitor.

When the monitor icons have been arranged, displays are connected as shown in this image.



- 9 Click **OK** to close the Display Properties screen.

Related Links

- "Setting Up Multi-Screen Display" [p.40](#)

Arranging the Multi-Screen Display (Mac OS X)

You can arrange the position of each display.

- 1 Connect an external monitor to the computer.
- 2 Check the following items when connecting over a wireless LAN and modify the settings as necessary. If the following items are not set correctly, the multi-screen display function cannot be used.
 - The SSID for the computer and each projector must be the same. (For Quick Connection Mode)
 - The wireless LAN system for the computer and each projector must be the same.
- 3 Double-click **EasyMP Network Projection** from the **Applications** folder to start EasyMP Network Projection.
- 4 Select **Quick Connection Mode** or **Advanced Connection Mode**, and then click **OK**.



In Quick Connection Mode, you cannot connect to multiple projectors and project different images to each projectors.

5 Select **Use multi-display**.

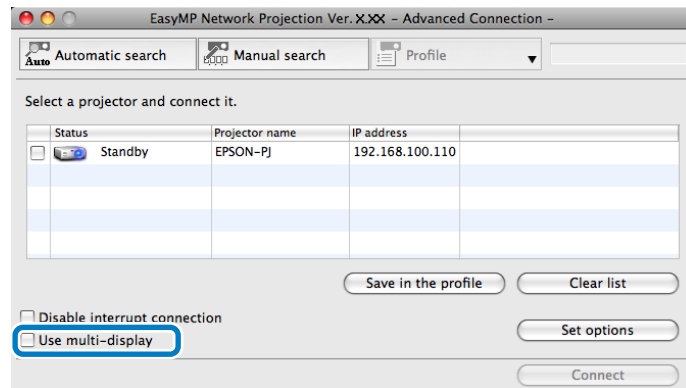

Display layout and **Display preferences** options are added at the bottom of the screen.

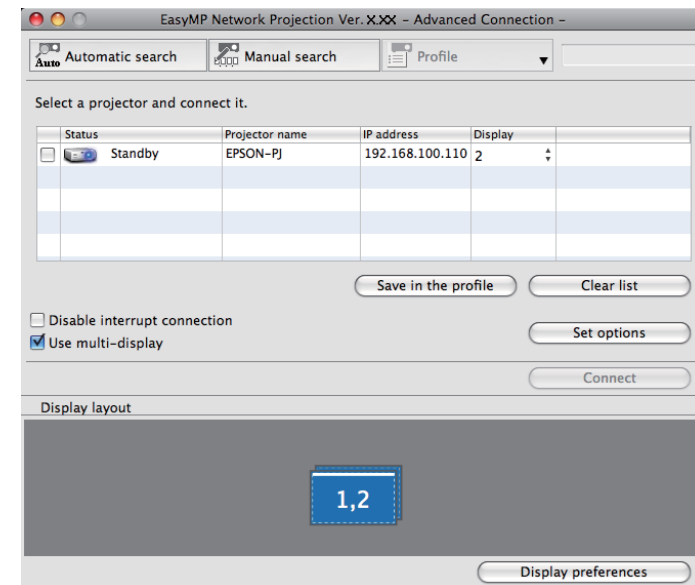

6 Click **Display preferences**.

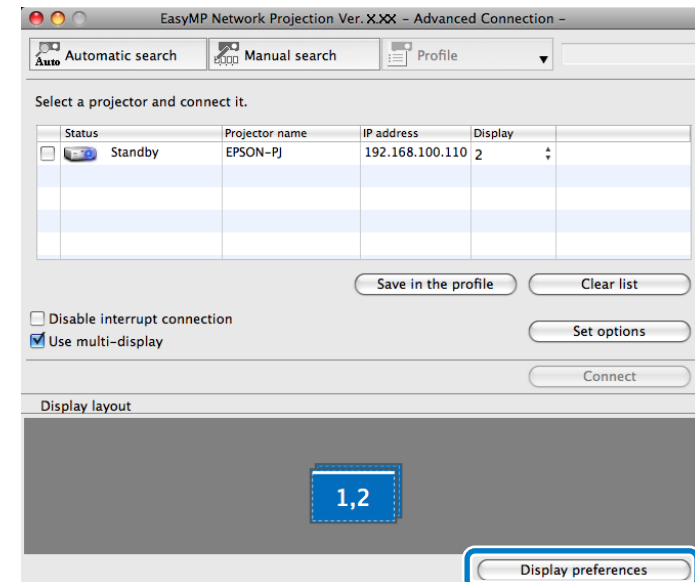

The Display setting screen is displayed.

- 7 Click **Arrangement**.

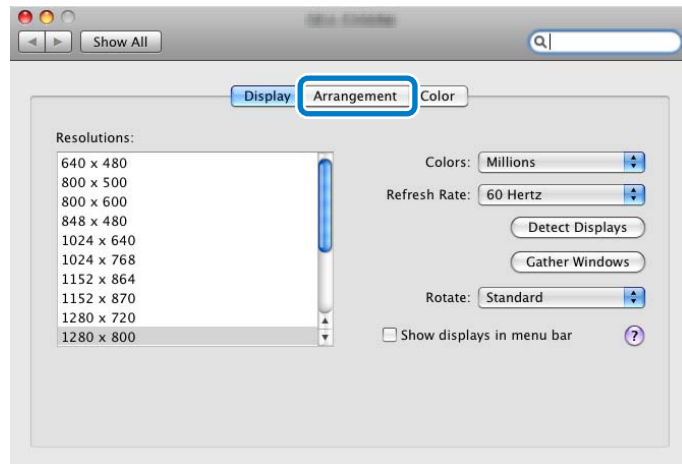

- 8 Clear **Mirror Displays**.

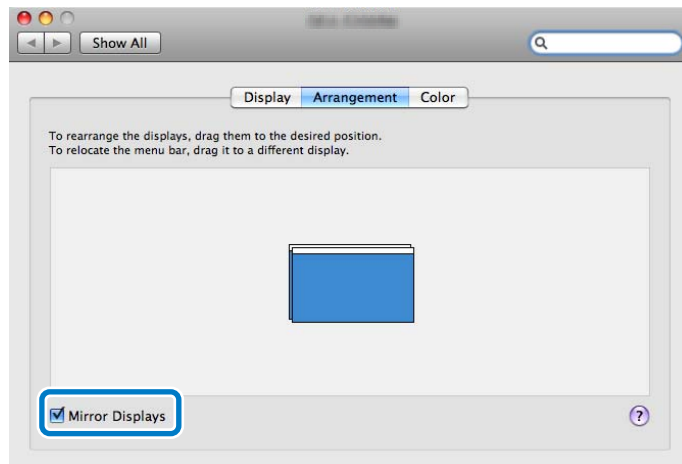

- 9 Drag the displayed monitor icon and place it where you want the additional image to appear.

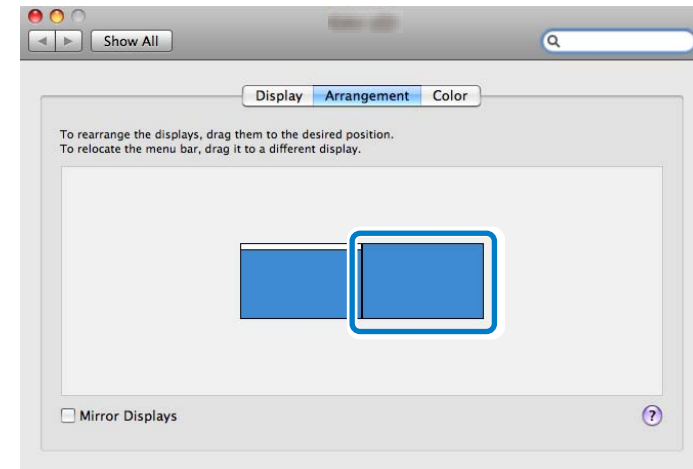

- 10 Close the Display setting screen.

Related Links

- "Setting Up Multi-Screen Display" [p.40](#)

Projecting Images to the Arranged Multi-Screen Display

After setting up multi-screen display, you can assign the images you want to project to each screen.

- 1 Open the file you want to project.
- 2 Drag the window to the desired display, and assign where the image is to be projected.

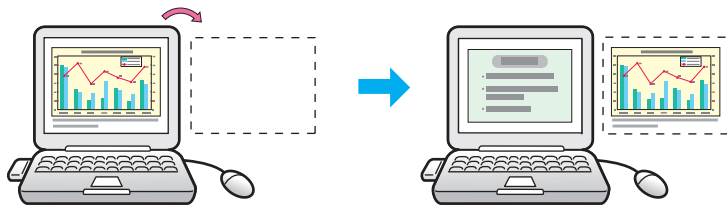

3 Select the projector and the number you want to assign from **Display** to set which image you want to project from which projector.

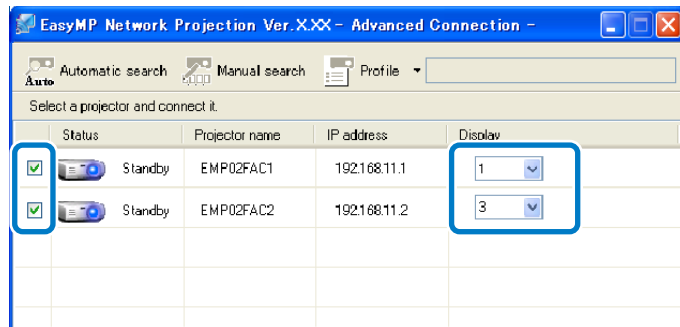

4 Click **Connect**.

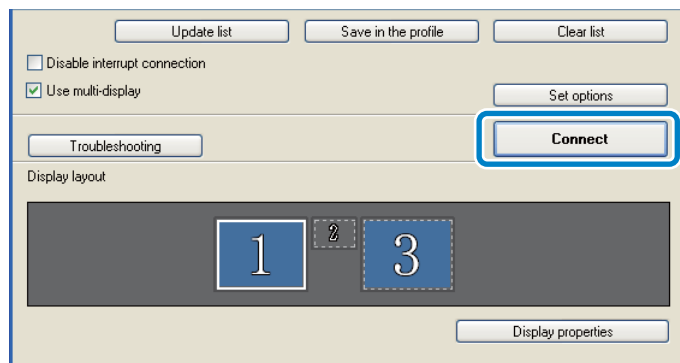

The image assigned to each projector is projected.

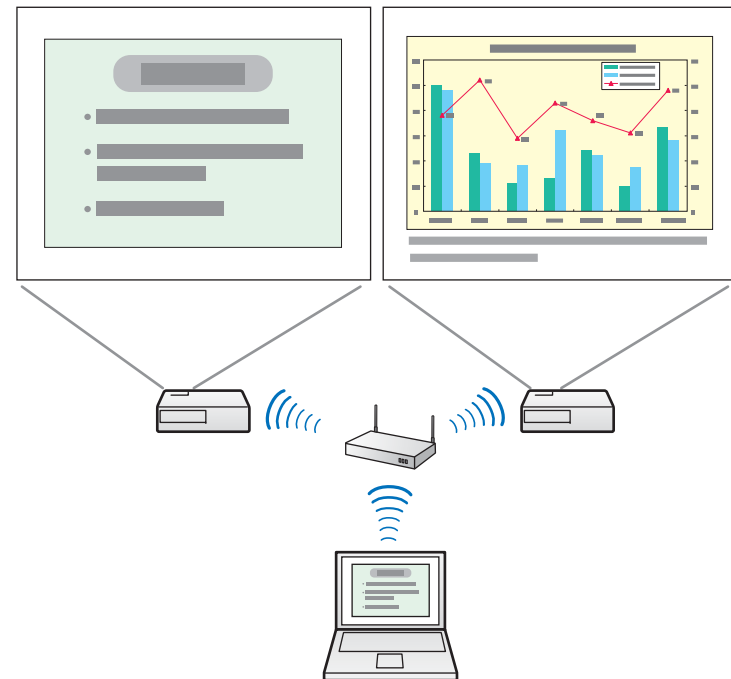

 If you use a virtual display on Windows, you cannot view the image being sent to a virtual display on the computer. To adjust the image on the virtual display, check the projected image. To perform mouse-based operations on the virtual display, move the mouse pointer in the direction of the virtual display so that the pointer appears on the virtual display.

5 To end projection for multi-screen display, click **Disconnect** on the toolbar.

Related Links

- "Setting Up Multi-Screen Display" [p.40](#)

You can project one computer screen from up to four projectors simultaneously.

When you connect to the projectors in **Quick Connection Mode**, you need to set the same SSID for all of the projectors you want to connect to.

- 1** Start EasyMP Network Projection.
 - Windows XP, Windows Vista, and Windows 7: Click **Start**, select **Programs** (or **All Programs**), **EPSON Projector**, **EasyMP Network Projection**, and then click **EasyMP Network Projection V2.XX**.
 - Windows 8: Select **Search** on the Charms, and then select **EasyMP Network Projection Ver.X.XX**.
 - Mac OS X: Double-click **EasyMP Network Projection** from the **Applications** folder.
- 2** Select **Quick Connection Mode** or **Advanced Connection Mode**, and then click **OK**.
- 3** Select the projectors you want to connect to, and then click **Connect**.

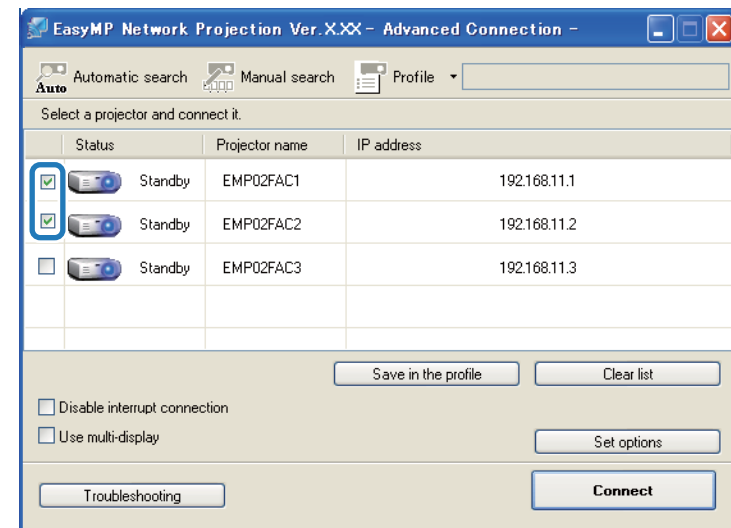

The same image is projected from multiple projectors.

Related Links

- "Using Additional Functions" [p.33](#)



Solving Problems

See the following sections to check for solutions to problems you may have using EasyMP Network Projection.

Related Links

- "Solving Network Connection Problems" [p.49](#)
- "Solving Problems During Projection" [p.53](#)
- "Error Messages List" [p.55](#)
- "Event ID List" [p.58](#)

Try these solutions depending on your network environment.

Related Links

- "Solving Problems" [p.48](#)
- "Solutions When You Cannot Connect Using Quick Connection Mode" [p.49](#)
- "Solutions When You Cannot Connect Projectors Using Advanced Connection Mode (Wireless)" [p.50](#)
- "Solutions When You Cannot Connect Projectors Using Advanced Connection Mode (Wired)" [p.51](#)

Solutions When You Cannot Connect Using Quick Connection Mode

When you cannot connect the computer and the projector using Quick Connection Mode, try the following solutions.

- Check the status of the external devices used for the network connection or the setting environment of the projector.
 - Connect the specified wireless LAN unit to the projector securely.
 - Check for any obstacles between the computer and projector, and change their position to improve communication. Sometimes the indoor environment prevents the projector from being found in a search.
 - Set the radio strength for the network devices to the maximum.
- Check the projector's network settings.
 - Set the **Connection Mode** setting to **Quick**.
Go to **Network > Network Configuration > Wireless LAN > Connection Mode**.
 - Set an SSID that is different from the SSID for the access point.
Go to **Network > Network Configuration > Wireless LAN > SSID**.
 - Set **DHCP** to **Off**.
Go to **Network > Network Configuration > Wireless LAN > DHCP** or **Network > Network Configuration > Wireless LAN > IP Settings > DHCP**.
 - Set **Wireless LAN Power** to **On**.
Go to **Network > Network Configuration > Wireless LAN > Wireless LAN Power**.
 - When you enable the security setting, set the same passphrase to the computer and the projector.
 - Close network settings on the projector, and then return to the LAN standby screen.
- Check the computer's network settings.
 - If the wireless LAN adapter is not installed on your computer, install a wireless LAN card on your computer.
 - Enable the wireless LAN setting or AirPort on your computer.
- Check the software settings.
 - If another user has established a connection and the projected image remains as it is, you can connect by interrupting the current connection.
If a Projector Keyword is set for the projector but you do not know the keyword, restart the projector and check the keyword displayed on the LAN standby screen.
 - If you cannot select or change the connection mode, select **Display Connection Mode Selection window on startup** on the **General settings** tab from Set options. The select connection mode screen is displayed after restarting the software.

Related Links

- "Solving Network Connection Problems" [p.49](#)
- "Set options - General settings" [p.66](#)
- "Changing the Computer Projection Source" [p.34](#)

Solutions When You Cannot Connect Projectors Using Advanced Connection Mode (Wireless)

When you cannot connect the computer and the projector using Advanced Connection Mode over a wireless network, try the following solutions. If you cannot resolve the problem, contact your network administrator.

- Check the status of the external devices used for the network connection or the environment in which the network devices and the projector are located.
 - Connect the specified wireless LAN unit to the projector securely.
 - Check for any obstacles between the access point and the computer or projector, and change their position to improve communication. Sometimes, indoor environments prevent the projector from being found in a search.
 - Set the radio strength for the network devices to the maximum.
 - Set the IP address, the subnet mask, and the gateway address for the access point correctly.
 - Make sure the Wireless LAN conforms to 802.11a, 802.11b, 802.11g, or 802.11n. The Wireless LAN is not compatible with other standards such as 802.11.
- Check the projector's network settings.
 - Set the **Connection Mode** setting to **Advanced**.
Go to **Network > Network Configuration > Wireless LAN > Connection Mode**.
 - Set the computer, the access point, and the projector to the same SSID.
Go to **Network > Network Configuration > Wireless LAN > SSID**.
 - Set **DHCP** to **Off**. When **DHCP** is set to **On**, it may take some time to enter LAN standby status if an available DHCP server is not found.
Go to **Network > Network Configuration > Wireless LAN > DHCP** or **Network > Network Configuration > Wireless LAN > IP Settings > DHCP**.
 - Set the IP address, the subnet mask, and the gateway address for the projector correctly.
 - Set **Wireless LAN Power** to **On**.
Go to **Network > Network Configuration > Wireless LAN > Wireless LAN Power**.
 - Set the wireless LAN system to meet the standards supported by the access point.
Go to **Network > Network Configuration > Wireless LAN > Wireless LAN system** or **Wireless LAN Sys**.
 - When you enable the security setting, set the same passphrase to the access point, the computer, and the projector.
 - Close network settings on the projector, and then return to the LAN standby screen.

- Check the computer's network settings.
 - If the wireless LAN adapter is not installed on your computer, install a wireless LAN card on your computer.
 - Enable the wireless LAN setting or AirPort on your computer.
 - Connect to the access point to which the projector is connected.
 - Turn off the firewall. If you do not want to turn it off, register the firewall as an exception. Make the necessary settings to open the ports. The ports used by this software are "3620", "3621", and "3629".
- Check the access point settings.
 - Set connection permission at the access point to allow projectors to connect if any functions that block connections, such as MAC Address restrictions and port restrictions, are set to the access point.
- Check the software settings.
 - Select the network adapter you are using from **Switch LAN** on the Set options screen. If the computer has multiple LAN environments, a connection cannot be established unless the network adapter is selected correctly.
 - If you cannot find the projector you want to connect to using **Automatic search**, select **Manual search** to specify the IP address.
 - If another user has established a connection and the projected image remains as it is, you can connect by interrupting the current connection.

If a Projector Keyword is set for the projector but you do not know the keyword, restart the projector and check the keyword displayed on the LAN standby screen.
 - If you cannot select or change the connection mode, select **Display Connection Mode Selection window on startup** on the **General settings** tab from Set options. The select connection mode screen is displayed after restarting the software.

Related Links

- "Solving Network Connection Problems" [p.49](#)

- "Set options - General settings" [p.66](#)
- "Searching for Network Projectors by Specifying an SSID, IP Address, or Projector Name" [p.24](#)
- "Changing the Computer Projection Source" [p.34](#)

Solutions When You Cannot Connect Projectors Using Advanced Connection Mode (Wired)

When you cannot connect the computer and the projector using Advanced Connection Mode over a wired network, try the following solutions. If you cannot resolve the problem, contact your network administrator.

- Check the status of the external devices used for the network connection or the environment in which the network devices and the projector are located.
 - Connect the network cable securely.



- Use a commercially available 100BASE-TX or 10BASE-T LAN cable.
- To prevent malfunctions, use a category 5 or higher shielded LAN cable.

- Check the projector's network settings.
 - Set **DHCP** to **Off**. When **DHCP** is set to **On**, it may take some time to enter LAN standby status if an available DHCP server is not found.

Go to **Network > Network Configuration > Wired LAN > DHCP** or **Network > Network Configuration > Wired LAN > IP Settings > DHCP**.
 - Set the IP address, the subnet mask, and the gateway address for the projector correctly.
 - Close network settings on the projector, and then return to the LAN standby screen.

- Check the computer's network settings.
 - Enable LAN settings on your computer.
Windows XP: Check **Control Panel > System > Hardware > Device Manager**.
Windows Vista, Windows 7, and Windows 8: Check **Control Panel > System and Maintenance** or **System and Security > Device Manager**.
 - Turn off the firewall. If you do not want to turn it off, register the firewall as an exception. Make the necessary settings to open the ports. The ports used by this software are "3620", "3621", and "3629".
- Check the software settings.
 - Select the network adapter you are using from **Switch LAN** on the Set options screen. If the computer has multiple LAN environments, a connection cannot be established unless the network adapter is selected correctly.
 - If you cannot find the projector you want to connect to using **Automatic search**, select **Manual search** to specify the IP address.
 - If another user has established a connection and the projected image remains as it is, you can connect by interrupting the current connection.
If a Projector Keyword is set for the projector but you do not know the keyword, restart the projector and check the keyword displayed on the LAN standby screen.
 - If you cannot select or change the connection mode, select **Display Connection Mode Selection window on startup** on the **General settings** tab from Set options. The select connection mode screen is displayed after restarting the software.

Related Links

- "Solving Network Connection Problems" [p.49](#)
- "Set options - General settings" [p.66](#)
- "Searching for Network Projectors by Specifying an SSID, IP Address, or Projector Name" [p.24](#)

- "Changing the Computer Projection Source" [p.34](#)

Try these solutions depending on your situation.

Related Links

- "Solving Problems" [p.48](#)
- "Solutions When the Computer Screen is Not Displayed Properly" [p.53](#)
- "Solutions When the Screen is Not Projected Properly" [p.53](#)
- "Solutions When Audio is Not Played Properly" [p.54](#)

Solutions When the Computer Screen is Not Displayed Properly

If there are any problems with the computer screen, try the following solutions.

- If the mouse pointer is not displayed on the computer screen, it may have been moved onto the virtual display. Clear the virtual display checkbox on the Add-Remove Virtual Display screen. The mouse pointer returns to the screen display area.
- When you cannot find some application screen after you start it, it may be running on the virtual display. Clear the virtual display checkbox on the Add-Remove Virtual Display screen.
- If you start EasyMP Network Projection while PowerPoint is running, a slide show might not run. Make sure PowerPoint is closed and then start EasyMP Network Projection and a slide show.
- If the PowerPoint slide show is not displayed where you want when using the multi-screen display function, use PowerPoint 2003 or later to make settings and use two or more virtual displays. Or, limit the number of displays to one before displaying the PowerPoint slide show.

Related Links

- "Solving Problems During Projection" [p.53](#)
- "Enabling the Virtual Display Driver (Windows)" [p.40](#)

Solutions When the Screen is Not Projected Properly

If the screen is not projected or there are problems with the project images try the following solutions.

- When sending movies, use Advanced Connection Mode or set the Wireless LAN system to 802.11a to use Quick Connection Mode. Depending on the electromagnetic wave environment, the image and sound for movies may stop.
- If you are using a Microsoft Office application, stop moving the mouse pointer. If you move the mouse pointer continuously, the screen may not be refreshed quickly.
- If the mouse pointer flickers, try the following solutions.
 - Select **Make the movement of the mouse pointer smooth** on the **General settings** tab on the Set options screen.
 - Clear **Transfer layered window** on the **Adjust performance** tab on the Set options screen.
- The Media Player movie playback screen may not be projected depending on the computer.
- The screen saver preview may not be projected properly depending on the computer.
- If you are connected to multiple projectors, the screen transfer speed may decrease.
- When WEP encryption is enabled, the screen transfer speed may decrease.

Related Links

- "Solving Problems During Projection" [p.53](#)
- "Set options - General settings" [p.66](#)
- "Set options - Adjust performance" [p.67](#)

Solutions When Audio is Not Played Properly

If there is no audio coming from the projector, try the following solutions.

- Audio can only be transferred to one projector. When multiple projectors are connected to one computer, disconnect other projectors and try again.
- Select **Output audio from the projector** on the **Audio Output** tab on the Set options screen.
- If the volume for the computer is set to the minimum while the projector volume is set to the maximum, the noise may be mixed. Turn up the computer's volume and turn down the projector's volume.

Related Links

- "Solving Problems During Projection" [p.53](#)
- "Set options - Audio Output" [p.68](#)

When an error occurs, an error message is displayed on your computer screen. Check for your message and follow the instructions here to clear the error.

Related Links

- "Solving Problems" [p.48](#)
- "Error Messages when Starting up EasyMP Network Projection" [p.55](#)
- "Error Messages when Searching for and Selecting Projectors" [p.56](#)
- "Error Messages when Projecting" [p.56](#)

Error Messages when Starting up EasyMP Network Projection

Error Messages	Remedy
Cannot start this application while USB Display is running.	Close USB Display and then start EasyMP Network Projection. Do one of the following to close USB Display: <ul style="list-style-type: none"> • Windows: Disconnect the USB cable from the projector. • Mac OS X: Select Disconnect from the USB Display icon menu on the menu bar or Dock, and then remove the USB cable.
Cannot start this application while Quick Wireless Connection is running.	Close Quick Wireless Connection and then start EasyMP Network Projection. To close Quick Wireless Connection, perform External Device Removal from the icon on the task bar to remove the Quick Wireless Connection USB Key from the computer.
EasyMP Network Projection initialization failed.	Restart EasyMP Network Projection. If the message is still displayed, uninstall and then reinstall EasyMP Network Projection.

Error Messages	Remedy
Network adapter information could not be obtained.	Check the following items. <ul style="list-style-type: none"> • A network adapter is installed on the computer. • The driver for the network adapter being used is installed on the computer. • The network adapter is enabled. After checking, restart the computer and then restart EasyMP Network Projection. If you still cannot connect, check the network settings on the computer and the network settings on the projector.
Cannot be used with the current OS version. Reinstall EasyMP Network Projection.	Reinstall EasyMP Network Projection.

Related Links

- "Error Messages List" [p.55](#)
- "Uninstalling EasyMP Network Projection (Windows XP/Windows Vista/Windows 7)" [p.76](#)
- "Uninstalling EasyMP Network Projection (Windows 8)" [p.76](#)
- "Uninstalling EasyMP Network Projection (Mac OS X)" [p.77](#)
- "Installing EasyMP Network Projection (Windows)" [p.11](#)
- "Installing EasyMP Network Projection (Mac OS X)" [p.11](#)



Error Messages when Searching for and Selecting Projectors

Error Messages	Remedy
Cannot connect to the projector using this version of EasyMP Network Connection. Install the latest version of EasyMP Network Projection.	Install the current version of EasyMP Network Projection from the EPSON Projector Software CD-ROM supplied with the projector. You can download the latest version of EasyMP Network Projection from the Epson Web site.
Connection to the projector failed.	Try connecting again. If you still cannot connect to the projector, check the network settings on the computer and the network settings for the projector.
The keyword does not match. Re-enter the keyword displayed on the projector screen.	Check the Projector Keyword displayed on the LAN standby screen, and enter the Projector Keyword.
Connection failed due to keyword mismatch.	
Enter the keyword displayed on the projector screen.	
The selected projector is busy. Do you want to continue the connection process?	If you click Yes , a connection to the projector is established. The projector is disconnected from the other computer. If you click No , a connection to the projector is not established. The connection between the projector and the other computer is maintained.
One or more connected projectors do not support resolutions greater than SXGA. Reduce the screen resolution and reconnect.	There is an incompatible projector in the connection destination. Change the computer screen resolution to SXGA (1280 × 1024) or less.

Error Messages	Remedy
One or more projectors are not responding.	Check the network settings on the computer and the network settings on the projector.
The wireless LAN is off. Turn on the wireless LAN, and then try searching again.	Turn on your computer's wireless LAN, and then try searching for the projector again.

Related Links

- "Error Messages List" [p.55](#)
- "Supported Resolutions" [p.78](#)
- "Uninstalling EasyMP Network Projection (Windows XP/Windows Vista/Windows 7)" [p.76](#)
- "Uninstalling EasyMP Network Projection (Windows 8)" [p.76](#)
- "Uninstalling EasyMP Network Projection (Mac OS X)" [p.77](#)
- "Getting the Latest Version of the Application" [p.76](#)
- "Installing EasyMP Network Projection (Windows)" [p.11](#)
- "Installing EasyMP Network Projection (Mac OS X)" [p.11](#)

Error Messages when Projecting

Error Messages	Remedy
XXXXXX was disconnected.	Try connecting again. If you still cannot connect to the projector, check the network settings on the computer and the network settings for the projector.
To output audio from the projector, restart applications such as PowerPoint or Windows Media Player.	Restart PowerPoint or Windows Media Player. Audio is then output from the projector.

Error Messages	Remedy
You need to restart your computer to enable Audio Output. Select Yes to restart now or select No to restart later.	To transfer audio to the projector and play back, select Yes and restart the computer.

Related Links

- "Error Messages List" [p.55](#)

When a connection error occurs, a number indicating the type of error is displayed as follows.

Event ID: 04xx

Check the numbers and then apply the following countermeasures. If you cannot resolve the problem, contact your network administrator, or contact Epson as described in your projector *User's Guide*.

Event ID	Cause	Remedy
0432	Failed to startup the network software.	Restart the projector.
0435		
0434	Network communication is unstable.	Check the network communication status, and reconnect after waiting for a while.
0481		
0482		
0433	Cannot play transferred images.	Restart the network software.
0484	Communication was disconnected from the computer.	
04FE	The network software ended unexpectedly.	Check the status of network communications. Restart the projector.
04FF	A system error occurred in the projector.	Restart the projector.
0891	Cannot find an access point with the same SSID.	Set the computer, the access point, and the projector to the same SSID.
0892	The WPA/WPA2 authentication type does not match.	Check that the wireless LAN security settings are correct.
0893	The WEP/TKIP/AES encryption type does not match.	
0894	Communication was disconnected because the projector connected to an unauthorized access point.	Contact your network administrator for more information.

Event ID	Cause	Remedy
0898	Failed to acquire DHCP.	Check the DHCP server to see if it is operating correctly and check the LAN cable to see if it is connected correctly. If you are not using DHCP, set DHCP to Off .
0899	Other communication errors	If restarting the projector or the network software does not solve the problem, contact Epson as described in your projector <i>User's Guide</i> .
089A	The EAP authentication type is not the same.	Check that the wireless LAN security settings are correct. Also, check if the certificate is installed correctly.
089B	EAP server authentication failed.	
089C	EAP client authentication failed.	
089D	Key exchange failed.	
0B01	The built-in storage could not be detected correctly.	Perform Delete All Internal Data . When the internal storage is deleted correctly, plugin the power cord for the projector and turn it on. If it is not deleted correctly, contact Epson as described in your projector <i>User's Guide</i> . Go to Extended > Whiteboard Settings > Internal Storage .
0BFF	An error has occurred in the Whiteboard function.	Restart the projector.

Related Links

- "Solving Problems" [p.48](#)



Screen Summary

See these sections for more information about the EasyMP Network Projection screens.

Related Links

- "Select Connection Mode Screen" [p.60](#)
- "Search and Connect Screen" [p.61](#)
- "Profiles" [p.64](#)
- "Set options" [p.66](#)
- "Toolbar" [p.70](#)
- "Movie Sending Mode" [p.73](#)
- "Add-Remove Virtual Display" [p.74](#)

When you start EasyMP Network Projection, the select connection mode screen is displayed.

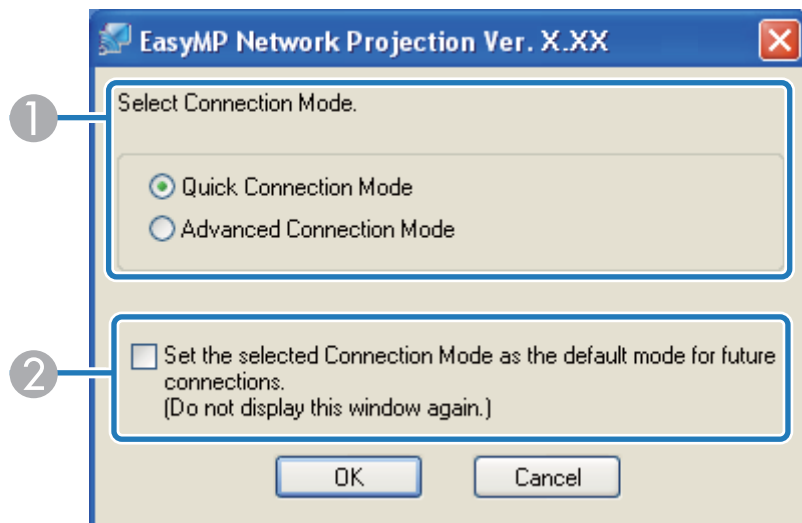

①	Select the connection mode.
②	Select to always connect using the selected connection mode.

Related Links

- "Screen Summary" [p.59](#)



When you start EasyMP Network Projection and select a connection mode, one of the following screens is displayed depending on the connection mode you selected.

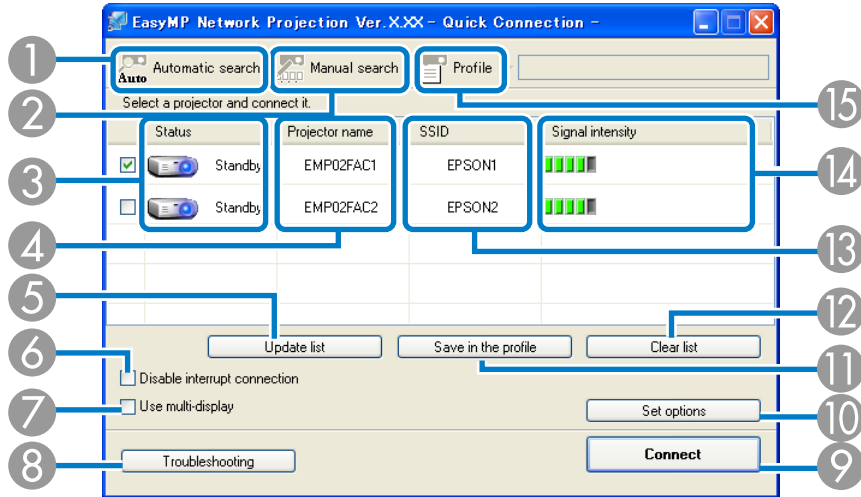



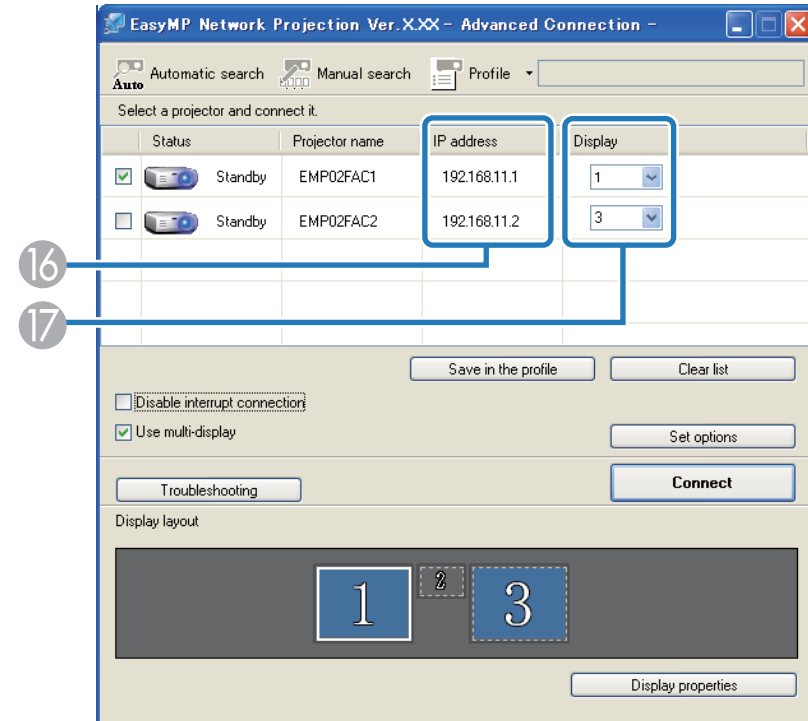

- When selecting Quick Connection Mode



- When selecting Advanced Connection Mode



①	 Automatic search	In Quick Connection Mode, searches for the projectors based on the SSID. In Advanced Connection Mode, searches for the available projectors on the network system to which the computer is connected.
②	 Manual search	In Quick Connection Mode, searches for the projector by using the SSID. In Advanced Connection Mode, searches for the projector by using an IP address or a projector name.
③	Status	Indicates the status for detected projectors as shown below.

		Available.
	Standby	
		Available. When you click Connect , the computer currently connected is disconnected and your computer is connected.
	Busy	
		Cannot be selected. Disable interrupt connection is set on another computer that is already connected.
	Busy (Disable interrupt connection)	
		The projector's Configuration menu is open. You can select it after closing the Configuration menu and running the search again.
	Currently in use by another application	
		Displayed while running Manual search or searching with a profile.
	Searching	
		Displayed when a projector cannot be found as a result of Manual search or search with a profile.
	Not found.	
		Available. Displayed when a projector with security settings enabled is found in Quick Connection Mode.
	Not acquired	
④	Projector name	Displays the projector's name.
⑤	Update list (Quick Connection Mode only)	Updates Status and Signal intensity.

⑥	Disable interrupt connection	Select to prevent an interrupt connection by other computers while connected to the selected projector.
⑦	Use multi-display	Select when using the multi-screen display function. When this is selected, Display layout and Display properties (Display preferences) are displayed at the bottom of the screen.
⑧	Troubleshooting	Displays the EasyMP Network Projection Troubleshooting screen.
⑨	Connect	Connects to the projector you selected from the search results list. When a connection is made with a projector, a toolbar is displayed.
⑩	Set options	Displays the Set options screen to make option settings such as the processing method when EasyMP Network Projection starts.
⑪	Save in the profile	Saves the results of a network projector search as a profile.
⑫	Clear list	Deletes all search results.
⑬	SSID (Quick Connection Mode only)	Displays the projector's SSID.
⑭	Signal intensity (Quick Connection Mode only)	Displays the signal intensity when a connection is made in Quick Connection Mode. As the Signal intensity increases, so does the number of lit indicators.
⑮	 Profile	Searches for a projector on the network using a profile saved using Save in the profile .
⑯	IP address (Advanced Connection Mode only)	Displays the projector's IP address.
⑰	Display	Select the display number (when Use multi-display is selected).



Related Links

- "Screen Summary" [p.59](#)
- "Searching for Network Projectors Automatically" [p.23](#)
- "Searching for Network Projectors by Specifying an SSID, IP Address, or Projector Name" [p.24](#)
- "Making a Profile" [p.26](#)
- "Performing a Profile Search" [p.25](#)
- "Projecting Images Using the Multi-Screen Display Function" [p.39](#)
- "Set options" [p.66](#)

See these sections for more information about the screens for saving and managing profiles.

Related Links

- "Screen Summary" [p.59](#)
- "Save in the profile" [p.64](#)
- "Edit profile" [p.64](#)

Save in the profile

When you search for projectors and click **Save in the profile** on the search and connect screen, one of the following screens is displayed.

- If no folder has been created.

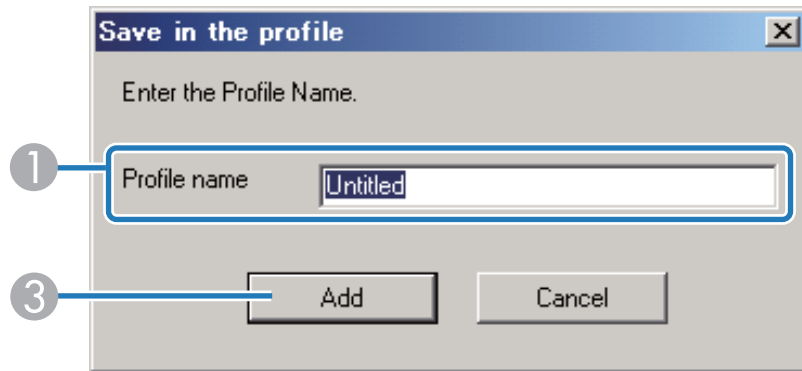

- If you have created a folder for profiles.

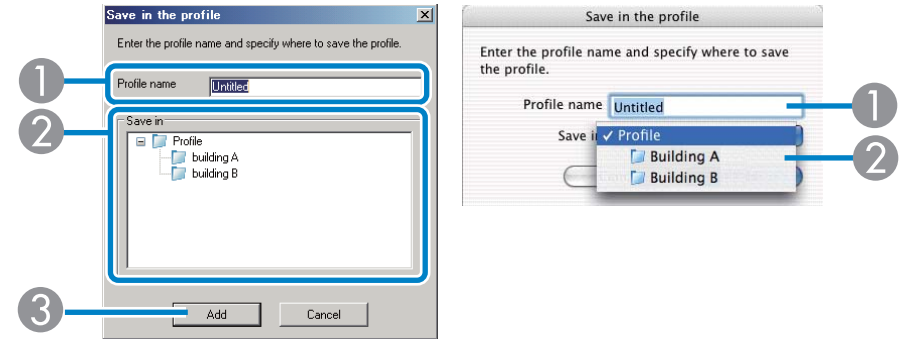

①	Profile name	Enter the profile name.
②	Save in	Select the folder where you want to save the profile.
③	Add	Registers the projector information in the profile.

Related Links

- "Profiles" [p.64](#)
- "Making a Profile" [p.26](#)

Edit profile

When you click **Edit profile** on the Set options screen, the Edit profile screen is displayed.

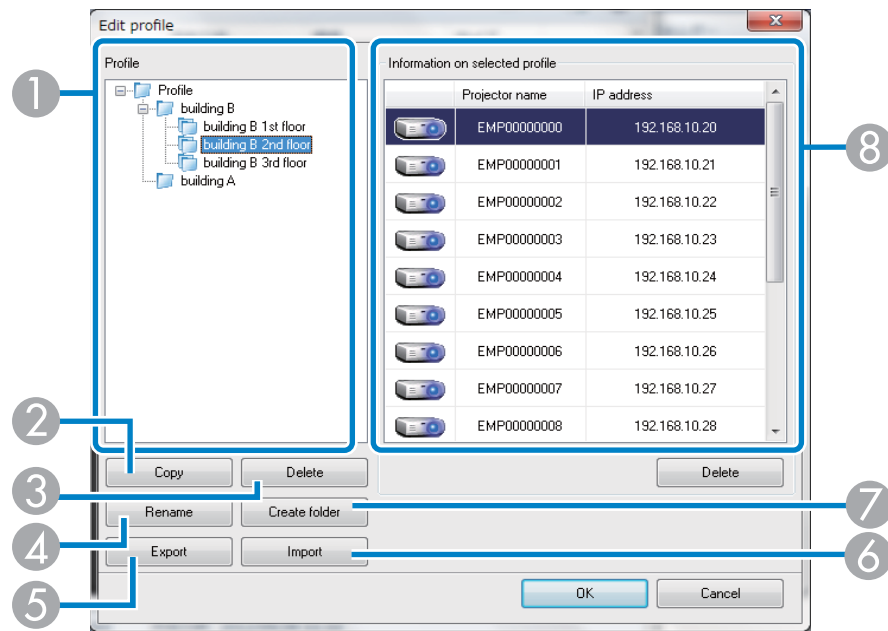



SSID or IP address	
Delete	Deletes the selected projector from the profile. When all projector information is deleted, the profile is also deleted.

Related Links

- "Profiles" p.64
- "Making a Profile" p.26

①	Profile	Displays the profile. You can drag and drop profiles and folders to change the folder structure.
②	Copy	Duplicates the profile. The copied profile is saved in the same folder as the original with the same name.
③	Delete	Deletes the profile and the folder.
④	Rename	Displays the Rename dialog box to rename the folder or the profile. You can enter up to 32 characters in the Rename dialog box.
⑤	Export	Exports the profile. Exported profiles can be used as backup files. You can import them on another computer.
⑥	Import	Loads an exported profile.
⑦	Create folder	Creates a new folder.
⑧	Projector name	Displays the projector information saved in the profile.

When you click **Set options** on the EasyMP Network Projection search and connect screen, the Set options screen is displayed.

 You can also access Set options by clicking the  button on the toolbar. When you access Set options from the toolbar, the **General settings** tab is not displayed.

Related Links

- "Screen Summary" [p.59](#)
- "Set options - General settings" [p.66](#)
- "Set options - Adjust performance" [p.67](#)
- "Set options - Audio Output" [p.68](#)

Set options - General settings

When you click the **General settings** tab on the Set options screen, the following screen is displayed.

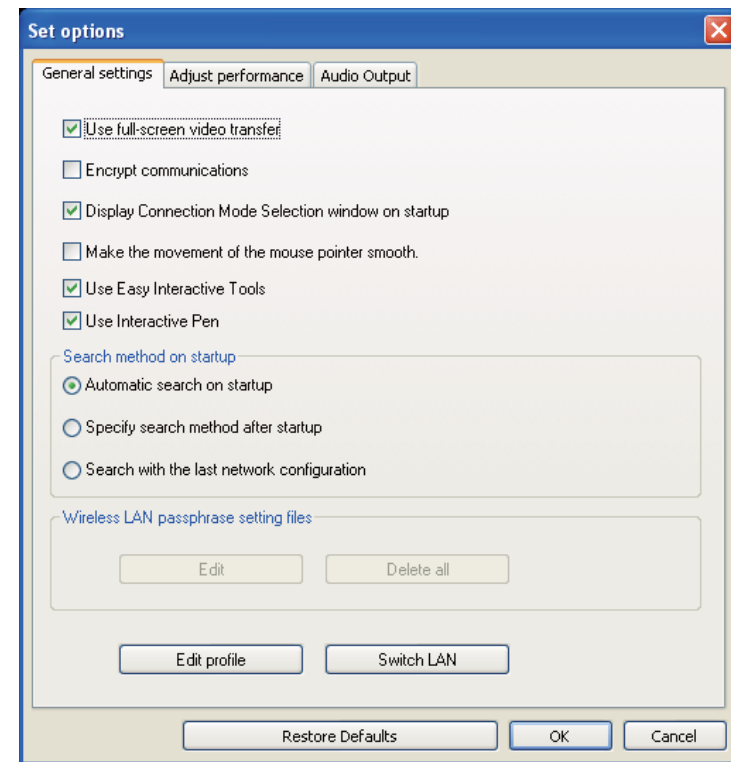

Use full-screen video transfer	Windows XP only Plays back a movie file at full screen. If the projector does not support movie sending, this function cannot be set.
Encrypt communications	Select to encrypt and transmit data. Even if data is intercepted, it cannot be decrypted. When using Quick Connection Mode, make sure you always select this checkbox.
Display Connection Mode Selection window on startup	Set whether or not the Select Connection Mode screen is displayed when EasyMP Network Projection starts. Clear this checkbox once you have settled on a regular startup method.

Make the movement of the mouse pointer smooth	Windows XP/Windows Vista/Windows 7 only Select to prevent the mouse pointer from flickering when Transfer layered window is selected in Adjust performance . (If Windows Aero is selected as the theme for Windows Vista and Windows 7, this setting turns off Windows Aero.)
Use Easy Interactive Tools	Select to use Easy Interactive Tools with EasyMP Network Projection. This setting is synchronized with Transfer layered window in Adjust performance .
Use Interactive Pen	Select to use the interactive function over a network (supported models only). You do not need to connect a computer to the projector with a USB cable. You can only use one Easy Interactive Pen at a time.
Search method on start-up	Select from the following projector search methods executed when EasyMP Network Projection is started. <ul style="list-style-type: none"> • Automatic search on startup • Specify search method after startup • Search with the last network configuration
Wireless LAN passphrase setting files	Not available for Windows XP. In Quick Connection Mode, SSIDs and passphrases are stored on the computer when connecting to a projector with security settings enabled. You can edit and delete the stored information. Edit: Displays the wireless network management screen for the computer. Delete all: Deletes all the SSIDs and passphrases stored on the computer.
Edit profile	The Edit profile screen is displayed.

Switch LAN	Windows only Use this setting if you need to switch the network adapter used to perform a search when a computer has multiple adapters. By default, all of the network adapters are used to perform a search.
Restore Defaults	Resets all adjustment values for Set options to their default settings, except for Edit profile and Switch LAN in General settings .

Related Links

- "Set options" [p.66](#)
- "Select Connection Mode Screen" [p.60](#)
- "Edit profile" [p.64](#)
- "Searching for Network Projectors Automatically" [p.23](#)
- "Searching for Network Projectors by Specifying an SSID, IP Address, or Projector Name" [p.24](#)

Set options - Adjust performance

When you click the **Adjust performance** tab on the Set options screen, the following screen is displayed.

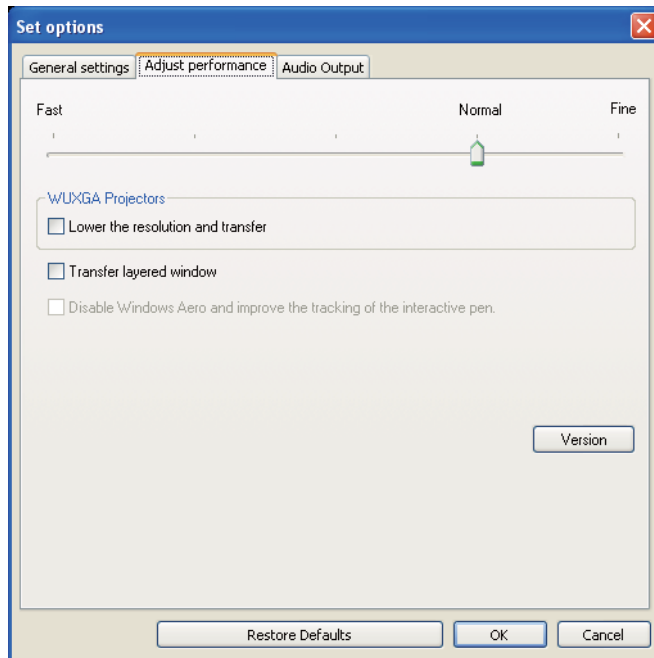

Performance adjustment slider	You can set the performance to Fast , Normal , and Fine . Set to Fast if movie projections are interrupted.
Lower the resolution and transfer	Available only for projectors with a resolution of WUXGA (1920 × 1200). Select to reduce the size of the data to be transferred to the projector by lowering the resolution. Use this option on a slow network or if it takes too long to display the image or projection is interrupted.

Transfer layered window	Windows XP and Windows 7 (when Windows 7 Basic is selected as the theme) only When using a layered window, contents such as messages displayed on the computer are not projected by the projector. Select this to project contents from a different layered window. If the mouse pointer flickers on the screen, select Make the movement of the mouse pointer smooth in General settings .
Disable Windows Aero and improve the tracking of the interactive pen	Only available when Windows Aero is selected as the theme in Windows Vista and Windows 7. Select to improve the tracking delay for the interactive pen. Windows Aero is disabled and interactive pen operations become smoother.
Restore Defaults	Resets all adjustment values for Set options to their default settings, except for Edit profile and Switch LAN in General settings .

Related Links

- "Set options" [p.66](#)

Set options - Audio Output

When you click the **Audio Output** tab on the Set options screen, the following screen is displayed.

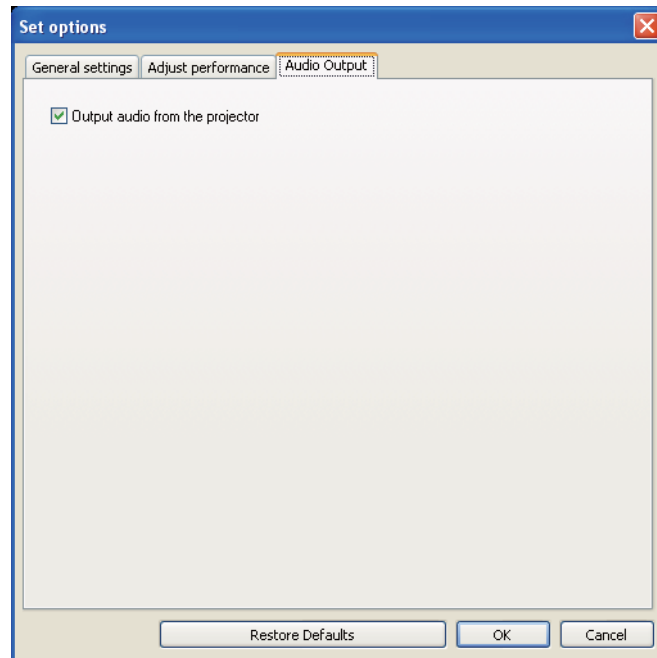







Related Links







- "Set options" [p.66](#)

<p>Output audio from the projector</p>	<p>Select to output the computer's audio from the projector. Clear to output audio from the computer. However, when playing movies with audio in Movie Sending Mode, audio is always output from the projector regardless of this setting.</p> <div data-bbox="510 1109 1048 1273" style="border: 1px solid black; padding: 5px; margin-top: 10px;">  <p>Audio can only be transferred to one projector. Audio cannot be transferred when connected to multiple projectors.</p> </div>
<p>Restore Defaults</p>	<p>Resets all adjustment values for Set options to their default settings, except for Edit profile and Switch LAN in General settings.</p>

After EasyMP Network Projection starts and a connection is made with the projector, the toolbar is displayed on the computer screen. You can use this toolbar to operate and make settings for the projector, and to disconnect the network connection.



 Select target projector	Displays the Select target projector screen. Click to limit the projectors operated from the toolbar when projecting from multiple projectors using the distribution function or multi-screen display function. The text below the icon indicates the projectors that can be controlled. ALL indicates that all of the connected projectors can be controlled. For example, when "1, 3" is displayed, projectors No. 1 and No. 3 can be controlled.
 Stop	Stops projection while connected to the projector. A black screen is projected while stopped.
 Show	Releases Stop or Pause.
 Pause	Pauses projected images while connecting to the projector.
 Presentation Mode	Switches Presentation Mode between enabled/disabled.
 Projector control	Displays the Projector control toolbar. Click to turn the video and audio on or off, or switch the input source.

 Screen Preview	Displays the multi-screen preview screen. Click to display a preview with the settings you have made. Click each display to enlarge each Screen Preview to full-screen.
 Set options	Displays the Set options screen. Click to adjust the transmission performance during the transfer of computer images.
 Movie Sending Mode	Starts Movie Sending Mode. (Supported models only)
 Disconnect	Disconnects the connection to the projector.
 Signal intensity (Quick Connection Mode only)	Displays the signal intensity when a connection is made in Quick Connection Mode. As the Signal intensity increases, so does the number of lit indicators.
 Switch toolbar display	Switches the toolbar display between Full , Normal , and Simple . The toolbar display remains as is until switched again.

Related Links



- "Screen Summary" [p.59](#)
- "Select target projector" [p.71](#)
- "Projector control" [p.71](#)
- "Hiding Computer Operations" [p.30](#)
- "Projecting Only a PowerPoint Slide Show" [p.35](#)
- "Finishing Projecting Images" [p.32](#)
- "Set options" [p.66](#)

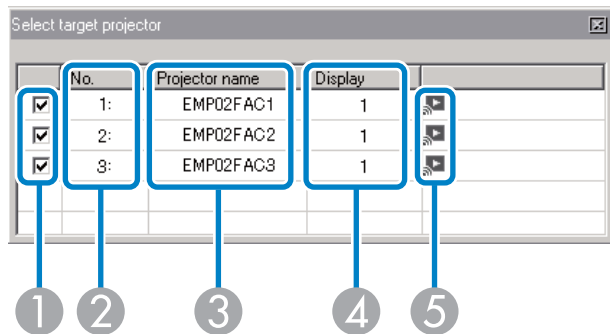

- "Projecting Movies" [p.36](#)

Select target projector

When you click the  button on the toolbar, the following screen is displayed.



①	-	Select the projector you want to control.
②	No.	Indicates the number assigned to the projector. This number appears under the icon to indicate the number of the projector that you can control from the toolbar.
③	Projector name	Displays the projector's name.
④	Display	Displays the display number you selected on the EasyMP Network Projection search and connect screen.
⑤	-	Indicates the following status of the projector.
		Projection has stopped.
		Currently projecting.

	Projection has been paused.
	During the Presentation Mode.
	During the Movie Sending Mode.



Related Links

- "Toolbar" [p.70](#)
- "Search and Connect Screen" [p.61](#)
- "Hiding Computer Operations" [p.30](#)
- "Projecting Only a PowerPoint Slide Show" [p.35](#)
- "Projecting Movies" [p.36](#)

Projector control

When you click the  button on the toolbar, the following toolbar is displayed.



	Hides and mutes the video and audio.
A/V Mute	
	Changes to images from the input port to which the computer or USB device are connected.
Switch PC source	





 <p>Switch video source</p>	<p>Changes to images from the video input port.</p>
--	---

Related Links

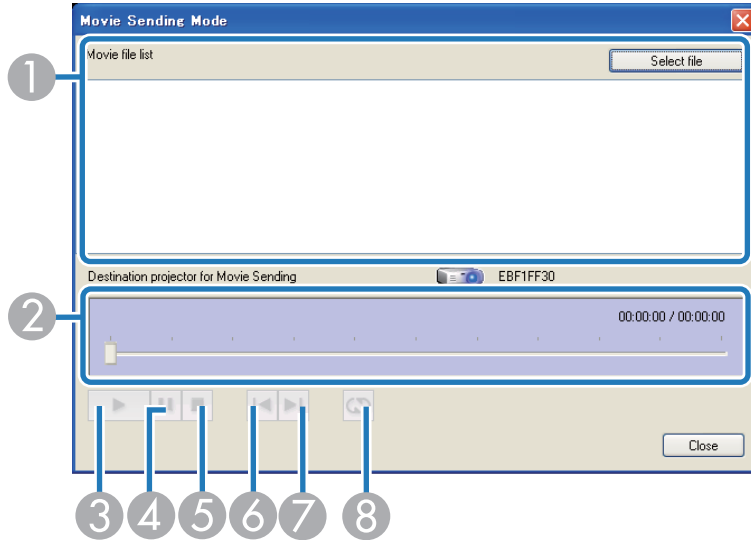
- "Toolbar" [p.70](#)
- "Hiding Computer Operations" [p.30](#)
- "Switching the Input Source" [p.30](#)

When you click the  button on the toolbar and select a projector, the following screen is displayed.



①	Movie file list	Displays a list of selected movie files.
②	—	Displays the current point in the movie file. You can drag and drop the slider to the point where you want to start playing.
③		Plays the file.
④		Pauses play back.
⑤		Stops play back.
⑥		Plays the current file from the beginning.
⑦		Plays the next file from the beginning.

⑧		Plays repeatedly from the first file in the list. You cannot repeat one specific file if there are multiple files in the list.
---	---	--

Related Links

- "Screen Summary" [p.59](#)
- "Projecting Movies" [p.36](#)

During installation and startup of EasyMP Network Projection on Windows, the Add-Remove Virtual Display screen is displayed.

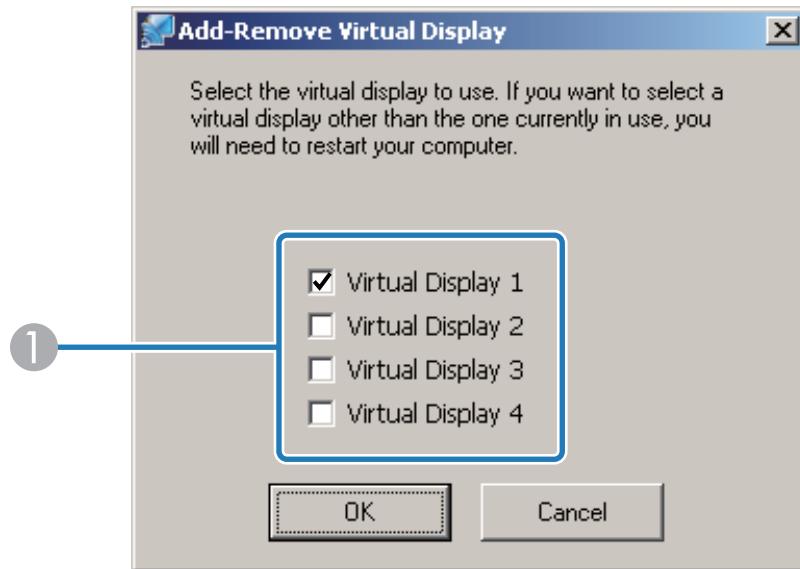

① Virtual Display 1 to 4	Select the virtual display you want to use for the multi-screen display function. You can select up to four monitors.
--------------------------	---

Related Links

- "Screen Summary" [p.59](#)
- "Enabling the Virtual Display Driver (Windows)" [p.40](#)



Appendix

See these sections to learn more about EasyMP Network Projection software.

Related Links

- "Updating and Uninstalling the Software" [p.76](#)
- "Supported Resolutions and Colors" [p.78](#)
- "Limitations" [p.79](#)
- "Notices" [p.81](#)

Follow these instructions to update or uninstall EasyMP Network Projection.

Related Links

- "Appendix" [p.75](#)
- "Getting the Latest Version of the Application" [p.76](#)
- "Uninstalling EasyMP Network Projection (Windows XP/Windows Vista/Windows 7)" [p.76](#)
- "Uninstalling EasyMP Network Projection (Windows 8)" [p.76](#)
- "Uninstalling EasyMP Network Projection (Mac OS X)" [p.77](#)

Getting the Latest Version of the Application

You can download the latest version of EasyMP Network Projection from the EPSON Web site.

Visit <http://www.epson.com>, and select your location.

Related Links

- "Updating and Uninstalling the Software" [p.76](#)

Uninstalling EasyMP Network Projection (Windows XP/Windows Vista/Windows 7)

For Windows XP, Windows Vista, and Windows 7, follow the instructions below to uninstall EasyMP Network Projection.



You need administrator authority to uninstall the software.

- 1** Turn on your computer.

- 2** Make sure all running applications are closed.

- 3** Click  **Start**, and then click **Control Panel**.

- 4** Do one of the following.

- Windows XP: Double-click **Add or Remove Programs**.
- Windows Vista and Windows 7: Click **Uninstall a program** from the **Programs** category.

- 5** Select **EasyMP Network Projection**, and then do one of the following.

- Windows XP: Click **Change/Remove**.
- Windows Vista and Windows 7: Click **Uninstall/Change**.

- 6** Follow the on-screen instructions.

Related Links

- "Updating and Uninstalling the Software" [p.76](#)

Uninstalling EasyMP Network Projection (Windows 8)

For Windows 8, follow the instructions below to uninstall EasyMP Network Projection.



You need administrator authority to uninstall the software.

- 1** Turn on your computer.

- 2 Make sure all running applications are closed.
- 3 Select **Search** on the Charms, and then search **EasyMP Network Projection**.
- 4 Right-click (press and hold) **EasyMP Network Projection Ver.X.XX**, and then select **Uninstall** from the app bar.
- 5 Select **EasyMP Network Projection**, and then select **Uninstall**.
- 6 Follow the on-screen instructions.

Related Links

- "Updating and Uninstalling the Software" [p.76](#)

Related Links

- "Updating and Uninstalling the Software" [p.76](#)

Uninstalling EasyMP Network Projection (Mac OS X)

For Mac OS X, follow the instructions below to uninstall EasyMP Network Projection.

- 1 Turn on your computer.
- 2 Make sure all running applications are closed.
- 3 Open the **Applications** folder.
- 4 Open the **EasyMP Network Projection - Tools** folder, and then double-click **EasyMP Network Projection Uninstaller.app**.
- 5 Follow the on-screen instructions.

Check these sections for the computer screen resolutions and the number of colors that EasyMP Network Projection can project.

Related Links

- "Appendix" [p.75](#)
- "Supported Resolutions" [p.78](#)
- "Display Color" [p.78](#)

Supported Resolutions

The following computer screen resolutions can be projected. You cannot connect to a computer with a resolution greater than WUXGA.

- VGA (640 × 480)
- SVGA (800 × 600)*
- XGA (1024 × 768)*
- SXGA (1280 × 960)
- SXGA (1280 × 1024)
- SXGA+ (1400 × 1050)*
- WXGA (1280 × 768)*
- WXGA (1280 × 800)*
- WXGA+ (1440 × 900)*
- UXGA (1600 × 1200)
- WUXGA (1920 × 1200)

* Supported resolutions when the multi-screen display function is on.

When using a computer screen with a unique aspect ratio, the resolution is increased or decreased depending on the resolution of the computer and the projector to avoid impairing image quality.

Depending on the resolution, the vertical or horizontal margins may be projected in black.

Related Links

- "Supported Resolutions and Colors" [p.78](#)

Display Color

The following number of computer screen colors can be projected.

Windows	Mac OS X
16-bit color	Approx. 32,000 colors (16-bit)
32-bit color	Approx. 16.7 million colors (32-bit)

The operational guarantee for multi-screen display is 16-bit and 32-bit color.

Related Links

- "Supported Resolutions and Colors" [p.78](#)

Check these sections for restrictions applied when projecting computer images while using EasyMP Network Projection.

Related Links

- "Appendix" [p.75](#)
- "Connection Limitations" [p.79](#)
- "Limitations when Projecting from Windows Photo Gallery or Windows Live Photo Gallery" [p.79](#)
- "Limitations in Windows Aero" [p.79](#)
- "Limitations when Projecting from Windows Media Center" [p.80](#)

Connection Limitations

Note the following limitations when using EasyMP Network Projection.

- If the transmission speed of the wireless LAN is low, the network may disconnect unexpectedly.
- Applications that use part of DirectX functions may not be displayed correctly (Windows only).
- You cannot project full-screen MS-DOS prompts (Windows only).
- There are times when the image on the computer screen and the image projected by the projector may not match exactly.
- Movies are not played as smoothly as they are on a computer.

Related Links

- "Limitations" [p.79](#)

Limitations when Projecting from Windows Photo Gallery or Windows Live Photo Gallery

Note the following limitations when launching Windows Photo Gallery or Windows Live Photo Gallery when using EasyMP Network Projection.

- Slideshow is played back in simple mode when projecting from Windows Photo Gallery or Windows Live Photo Gallery. Because the toolbar is not displayed, you cannot change the Theme (effects) while playing a slide show, regardless of the Windows Experience Index rating. Once simple mode has started, you cannot change modes while Windows Photo Gallery or Windows Live Photo Gallery is running, even if you close EasyMP Network Projection. Restart Windows Photo Gallery or Windows Live Photo Gallery.
- You cannot play movies.

Related Links

- "Limitations" [p.79](#)

Limitations in Windows Aero

Note the following limitations when the window design for your computer is Windows Aero.

- The layered window is projected regardless of the **Transfer layered window** setting on the Set options screen in EasyMP Network Projection. For example, when Transfer layered window for the EasyMP Network Projection toolbar is disabled, it is not projected even if it is displayed on the computer screen. However, the toolbar is projected.

- A few minutes after you connect a computer to the projector over a network with EasyMP Network Projection, the following message may be displayed.

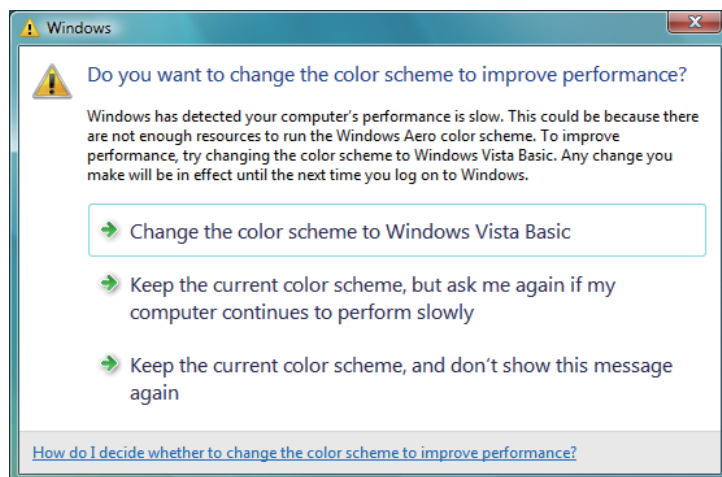

It is recommended that you select **Keep the current color scheme, and don't show this message again**. This selection is enabled until the computer is restarted.

Related Links

- "Limitations" [p.79](#)

- If audio stops during playback when transferring audio from the computer to the projector using EasyMP Network Projection, try restarting the application you are using.

Related Links

- "Limitations" [p.79](#)

Limitations when Projecting from Windows Media Center

Note the following limitations when projecting from Windows Media Center.

- You cannot project images in full screen mode using Windows Media Center. Switch to window display mode to project the images.

Check these sections for important notices about your projector.

Related Links

- "Appendix" [p.75](#)
- "Copyright Notice" [p.81](#)
- "About Notations" [p.81](#)
- "General Notice" [p.81](#)

Copyright Notice

All rights reserved. No part of this publication may be reproduced, stored in a retrieval system, or transmitted in any form or by any means, electronic, mechanical, photocopying, recording, or otherwise, without the prior written permission of Seiko Epson Corporation. No patent liability is assumed with respect to the use of the information contained herein.

Neither is any liability assumed for damages resulting from the use of the information contained herein.

Neither Seiko Epson Corporation nor its affiliates shall be liable to the purchaser of this product or third parties for damages, losses, costs, or expenses incurred by the purchaser or third parties as a result of: accident, misuse, or abuse of this product or unauthorized modifications, repairs, or alterations to this product, or (excluding the U.S.) failure to strictly comply with Seiko Epson Corporation's operating and maintenance instructions.

Seiko Epson Corporation shall not be liable against any damages or problems arising from the use of any options or any consumable products other than those designated as Original Epson Products or Epson Approved Products by Seiko Epson Corporation.

The contents of this guide may be changed or updated without further notice.

Illustrations in this guide and the actual projector may differ.

Related Links

- "Notices" [p.81](#)

About Notations

- Microsoft® Windows® XP Professional operating system
- Microsoft® Windows® XP Home Edition operating system
- Microsoft® Windows Vista® operating system
- Microsoft® Windows® 7 operating system
- Microsoft® Windows® 8 operating system

In this guide, the operating systems above are referred to as "Windows XP," "Windows Vista," "Windows 7," and "Windows 8." Furthermore, the collective term Windows may be used to refer to Windows XP, Windows Vista, Windows 7, and Windows 8, and multiple versions of Windows may be referred to as, for example, Windows XP/Vista, with the Windows notation omitted.

- Mac OS X 10.4.x
- Mac OS X 10.5.x
- Mac OS X 10.6.x
- Mac OS X 10.7.x
- Mac OS X 10.8.x

In this guide, the operating systems above are referred to as "Mac OS X 10.4.x," "Mac OS X 10.5.x," "Mac OS X 10.6.x," "Mac OS X 10.7.x," and "Mac OS X 10.8.x." Furthermore, the collective term "Mac OS X" is used to refer to them all.

Related Links

- "Notices" [p.81](#)

General Notice

IBM, DOS/V, and XGA are trademarks or registered trademarks of International Business Machines Corporation.

Macintosh, Mac, Mac OS, and iMac are trademarks of Apple Inc.

Microsoft, Windows, Windows NT, Windows Vista, PowerPoint, and Windows logo are trademarks or registered trademarks of Microsoft Corporation in the United States and/or other countries.

Other product names used herein are also for identification purposes only and may be trademarks of their respective owners. Epson disclaims any and all rights in those marks.

Software Copyright: This product uses free software as well as software to which this company holds the rights.

© SEIKO EPSON CORPORATION 2014. All rights reserved.

Related Links

- "Notices" [p.81](#)