

HIGH BRIGHTNESS BUSINESS PROJECTOR  
EB- L3000UNL

**EPSON**  
EXCEED YOUR VISION

# WORLD'S LIGHTEST & SMALLEST 30,000 LUMENS 3LCD LASER PROJECTOR.\*

**EPSON**  
EXCEED YOUR VISION



Presenting spectacular image quality with outstanding levels of colour brightness, the Epson EB-L3000UNL is among the world's lightest and smallest 30,000 lumens 3LCD projector with 4K quality lens. It is extremely reliable with superior heat resistance and 20,000 hours\*\* of maintenance-free use on its laser light source. Project any and every way you want with its flexible 360° rotation and adjustable tilt, and allow its variety of lenses to cater to all your projection needs!



**IT'S IN THE DETAILS.**

3LCD technology that delivers quality projected images and reliable performance.

Sales Enquiries  
800 120 5564

EpsonSEA EpsonSEA EpsonSEA EpsonSoutheastAsia Epson Southeast Asia



\* Based on Futuresource Consulting.

\*\* 20,000H life for laser light source: Approximate time until brightness decreases 50% from first usage. Measured by acceleration test assuming use of 0.04 - 0.20 mg/m<sup>3</sup> of particulate matter. Time varies depending on usage conditions and environments. Replacement of parts other than the light source may be required in a shorter period.

# IMAGE QUALITY PERFECTED



Projecting 30,000 lumens of advanced high brightness, EB-L30000UNL is the ideal companion you need for big-screen projections in large spaces. Enjoy better image stability thanks to improved optical components, it is also the perfect tool for live staging events, auditorium talks, and large boardroom meetings.

## Vivid Images Even in Large Spaces

Epson EB-L30000UNL is packed with 30,000 lumens and projects with a high contrast ratio. Guaranteed to produce bright images even in large venues, it works flawlessly in even well-lighted environment.



## Mesmerising Projection

Designed for large venues usage from visitor attractions to lecture theatres, the Epson EB-L30000UNL comes complete with 4K enhancement and supporting interchangeable lenses. Get ready to be mesmerised by vivid, detailed, and true to life images.

## Endless Stackable Possibilities

Wow your viewers with rich and versatile projections thanks to the projector's stackable design, achieved by its light and compact size. Robust design with base plate and pipe frame structure, enjoy the flexibility to stack your projectors to achieve double the brightness up to 60,000 lumens.



## Stable Image Quality

Marvel at projections with better colour and image stability thanks to the improved optical components with the EB-L30000UNL. You can now bring your audience zestful, high-impact live projections with confidence.

# POWERFUL YET COMPACT



High Contrast Ratio  
**>2,500,000:1**

Packing versatility and durability that suits any professional installation, the EB-L30000UNL is the perfect match for staging companies, hospitality markets and visitor attractions. Designed to captivate your audience, deliver crisp and vivid visuals with high contrasts even in bright and huge spaces.

## High Contrast Ratio with WUXGA – Beyond Full HD Resolution

Coupled with the EB-L30000UNL's high contrast ratio, enjoy clear and crisp Full HD video displays at the WUXGA resolution of 1,920 x 1,200 pixels. Down to the smallest detail even on large-screen projections, your audience will now be mesmerised by the dynamic, spectacular viewing experience.

Without special optical parts

With special optical parts

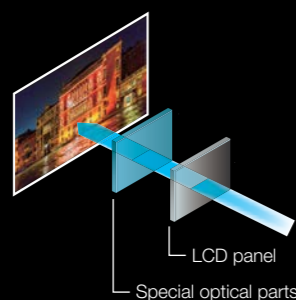
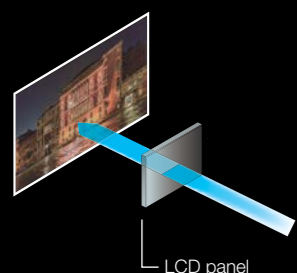

## Well-balanced Whites

The laser light source produces nicely balanced RGB colour for brilliant white highlights that bring a refreshing vibrancy to your images.

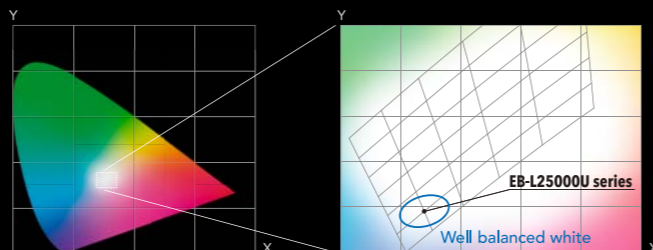

## High-definition Images with 4K Lens and Enhancement Technology

4K enhancement technology shifts each pixel diagonally by 0.5 pixels to double the resolution to 3840 x 2160, surpassing full HD image quality to give you unbelievable sharpness, clarity and detail on all your presentations.

By reengineering the internal structure, colour bleeding is kept to an absolute minimum to deliver 4K resolution throughout the entire zoom range.

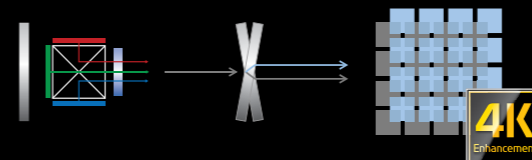

## Frame Interpolation

Enjoy clearer, sharper playback even on fast-moving subjects with Epson's Frame Interpolation Technology. This unique function effectively eliminates motion blurring by inserting intermediate frames between images to create smoother motion transition.



## Absolute Black

Laser technology dims the light source in real time according to the input video signal to deliver absolute black during full-black screens.

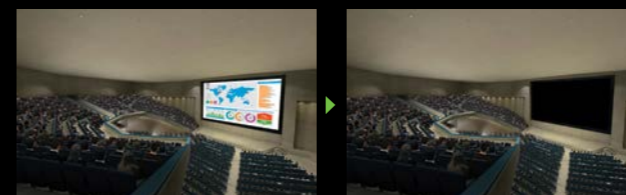

\* Simulated images

## Super Resolution with Detail Enhancement

Improve perceived image resolution with the "super resolution" technology. And with Epson's "detail enhancement", you enjoy rich textures for further enhancement in image quality, allowing you to select your preferred image characteristics for different scenes and content.



Without Super-resolution technology

With Super-resolution technology

# ABUNDANCE OF POSSIBILITIES

The **Epson Professional Tool** comes with built-in functions that lets you have the flexibility and ability to maximise the use of the Epson EB-L3000UNL projector.

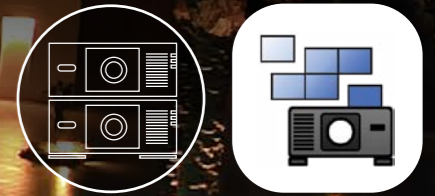

## Stacking Assist

Epson has taken projection mapping to the next level with stacking assist that can be performed using Epson Professional Tool software. The function aids the operator in performing two projectors stacking, and auto tiling assist, which allows edge-blended multi-projector to create one supersized image. This produces some impressive massive display that aim to wow!



## Geometry Correction

This function allows users to correct image distortion when projecting on a curved, right-angled screen and edge blending using the Geometry Correction feature without any hassle.

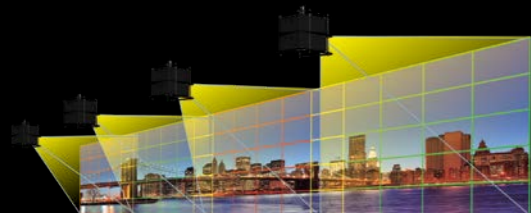

## Lights-Out Control

This function enables to project a black image in align with the lighting performance in a dark environment. And it can be controlled together with other lighting performance by using Art-Net Lighting Control system.

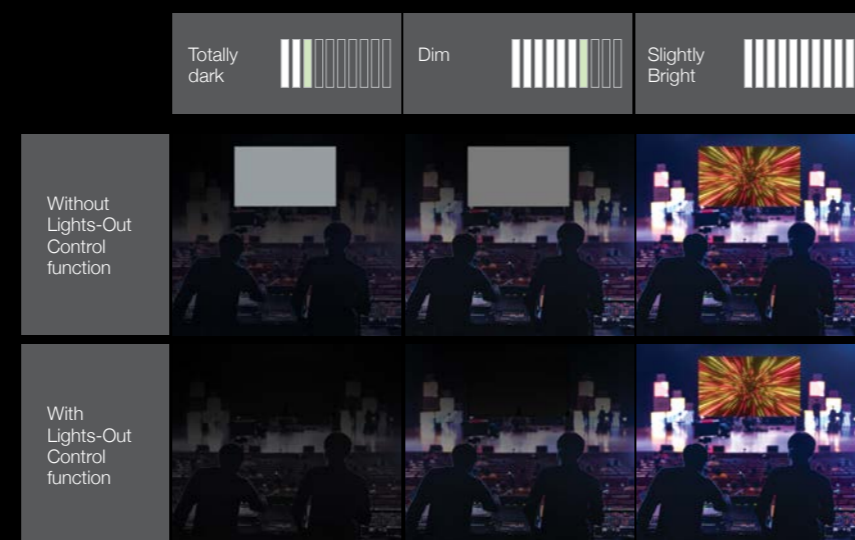

## Auto Colour Calibration

The built-in camera detects screens that became unevenly coloured over time, allowing the projector to automatically correct colour. It also detects subtle colour inconsistencies between multiple projectors. What's more, this function can be programmed to check colour manually or automatically at regular intervals to deliver stable image quality with minimum maintenance.

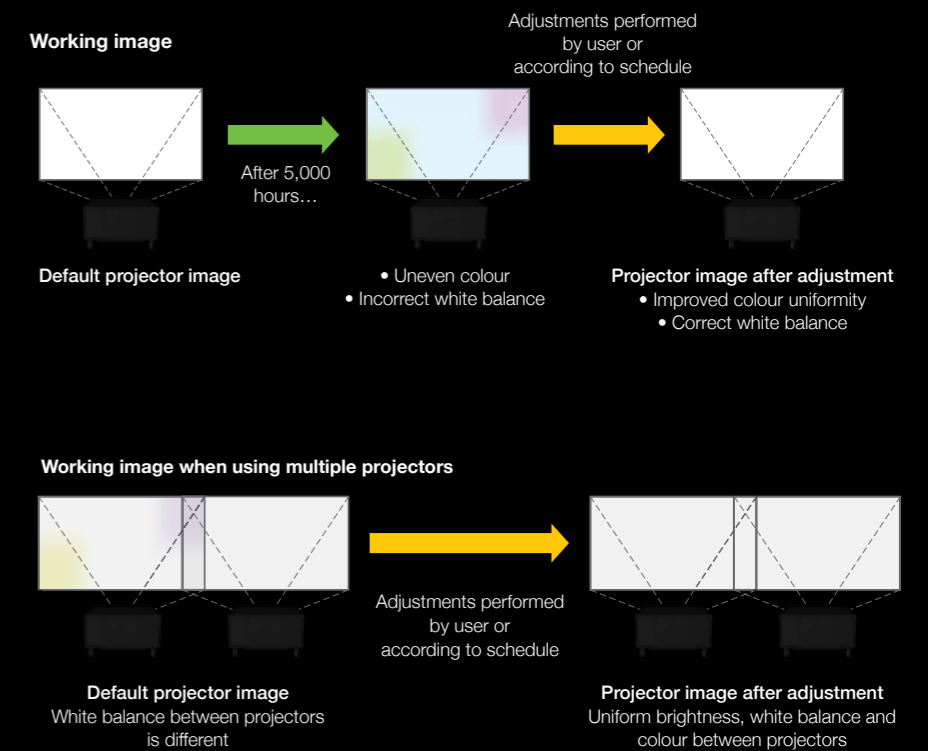

# RELIABLE PERFORMANCE



## Advanced Colour Adjustment

With the colour adjustment function, you can easily adjust the hue, saturation and brightness for each component of RGBCMY to match your preferences.

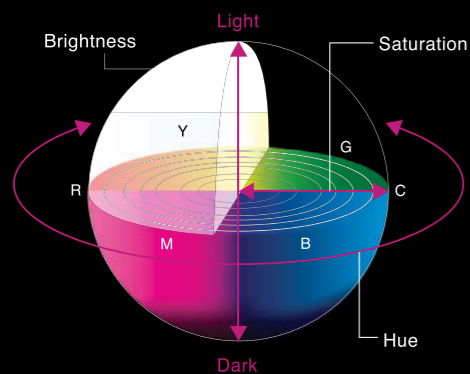

## Fine-tuning Brightness

The EB-L3000UNL provides precise brightness adjustment in increments of 1%. This combined with the Constant Brightness mode maintains brightness at a given value to match the venue or subject to deliver astonishing picture quality.

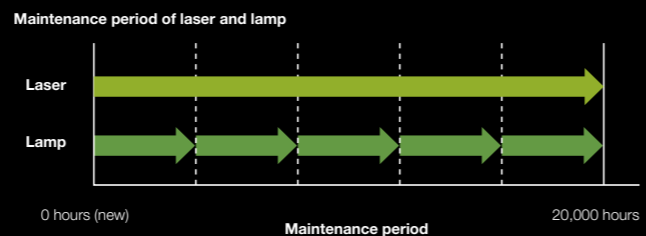
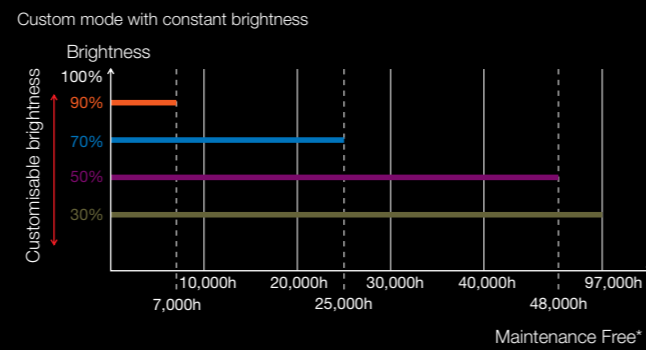

## 20,000 Hours of Maintenance-free Use

Engineered with inorganic LCD panels and an inorganic phosphor wheel. The newly designed laser light source delivers 20,000 hours\* of maintenance-free use for the laser light source only. And with the advanced electrostatic filter having an equally long-lasting life, you enjoy peace of mind in using this highly reliable laser projector.

## Inorganic LCD Panels and Phosphor Wheel for Outstanding Reliability

Made of inorganic material, Epson's newly developed phosphor wheel offers superior light and heat resistance to deliver excellent reliability. By combining this with our inorganic LCD panels, we create laser projectors that project bright, vibrant images for extremely long periods.

### Organic vs. Inorganic

	Inorganic (Glass, iron, aluminum, etc.)	Organic (Paper, wood, plastic, etc.)
Light-resistance	YES	NO
Heat-resistance	YES	NO

Unlike organic substances, inorganic substances do not contain carbon.

## Revolutionary Laser Light Source

Blue light from the laser is projected through a beam splitter, which divides the light into two beams. One beam passes through a phosphor wheel, turning it yellow, while the other beam remains blue. The two beams are then recombined into white light and separated into red, green and blue through dichroic mirrors. Each of the three colours passes through LCD panels, producing three individual images, which are transmitted through a prism and combined into the final full-colour image.

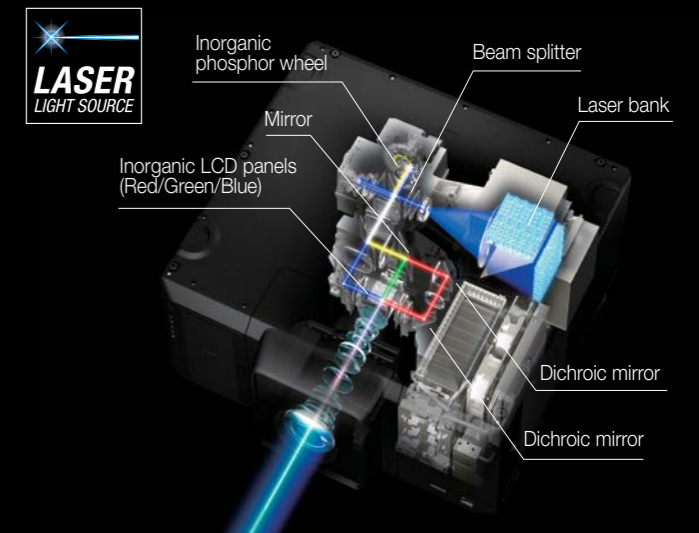

\* 20,000H life for laser light source : Approximate time until brightness decreases 50% from first usage. Measured by acceleration test assuming use of 0.04 - 0.20 mg/m<sup>3</sup> of particulate matter. Time varies depending on usage conditions and environments. Replacement of parts other than the light source may be required in a shorter period.

# VERSATILE INSTALLATION



## Sealed Optical Engine

Key optical components including the inorganic panel, inorganic phosphor wheel and laser bank are housed in a sealed structure to prevent external dust contamination. This means brightness deterioration due to dust is significantly reduced so you can use your projector even in a smoky environment\*.

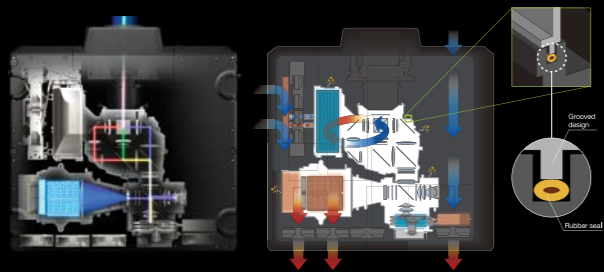

## Status Monitor

The projector body is equipped with an LCD monitor, allowing you to quickly check signal, voltage and network information.



## Durable and Compact Body

By redesigning the internal structure and adopting a pipe frame and baseplate structure, the durability of the casing is greatly improved to deliver a compact, lightweight design for easy installation.



## Screw Holes For Eyebolts\*\*

To ease live staging preparations, screw holes are provided on both the top and bottom, allowing strong threads to be attached to the durable yet compact projector.



## Worry-free Projection

With multiple laser diodes to reply on, the screen won't go black even if one diode goes out. This eliminates the worry of the projector light burning out during mission-critical presentations.

### Laser



The projector keeps working even when one light diode goes out.

### Lamp



The screen goes black when the lamp burns out.

## Power Supply Log

Monitor and log up to 30 drops in voltage for a detailed record and prevent unexpected shutdowns.

## Mechanical Shutter

The mechanical shutter inside the unit is protected against damage from laser lights that are sometimes part of lightshows.

## Powered Lens with Stepping Motor

The powered lens with stepping motor offers limitless possibilities in projector placement. Covering a wide range of angles, the motorised lens shift gives you a great deal of flexibility when installing the projector. The newly adopted stepping motor lets you make highly precise adjustments when employing edge blending, stacking and other techniques. Adjustments can also be made via remote control or over a network, enhancing usability even for ceiling-mounted projectors.

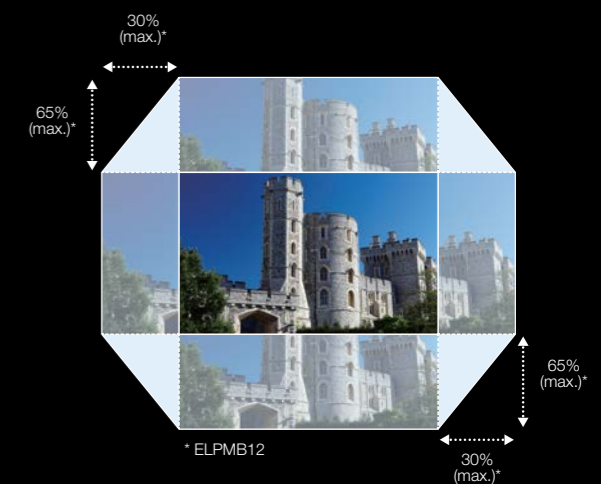

\*When using the projector in smoky environments such as at events and so on, make sure you replace the air filter every approximately 240 hours of use. It isn't guaranteed in all of the smoky environments. \*\*For transportation only.

# BOUNDLESS POSSIBILITIES



## Lens Position Memory

With storage for up to 10 settings in the projector memory, including shift positions, focus and projection sizes, you can easily and quickly adjust the projector according to the aspect ratio of content simply by using either the remote controller or command control.

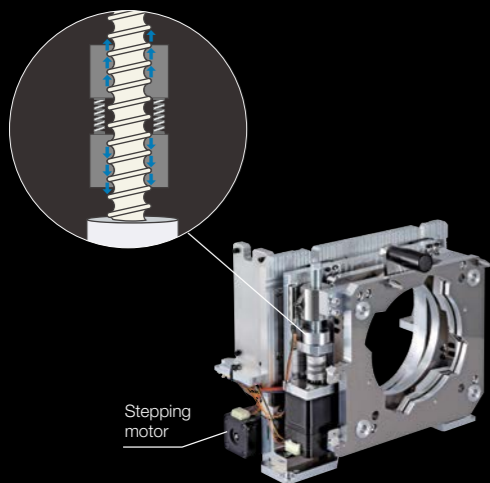

## Multi-directional Projection

The EB-L30000UNL can be rotated 360° in any direction — horizontally, vertically and rotationally — without any loss in image brightness, making it ideal for a wide range of applications, including projecting onto ceilings and floors.

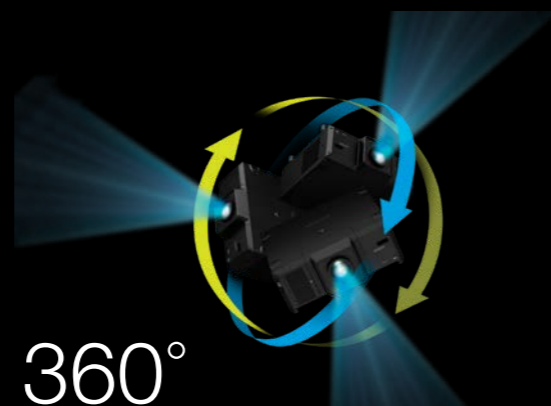

## Extensive Lens Options

The Epson EB-L30000UNL offers an extensive line-up of optional lenses to fit any venue or subject. And with 4K compatibility on all our lenses, you enjoy outstanding resolution regardless of your lens selection.

ELPLL10					6.96-10.45
ELPLL09				4.79-7.2	
ELPLM14			3.41-5.11		
ELPLM13		2.3-3.46			
ELPLM12		1.74-2.35			
ELPLW07		1.28-1.76			
ELPLU05		0.9-1.09			
ELPLR05		0.63			
ELPLX03 <b>NEW</b>		0.35			
	0.0	2.5	5.0	7.5	10.0

Throw ratio

## Wider Lens Shift Range

The extremely wide-ranging lens shift was realised through a change in design and careful consideration of the lens and optical engine. Coupled with an improved stepping motor, the range shift mechanism allows more precise adjustment for limitless possibilities in projector placement.

## Borderless Multi-projection

With a variety of functions available for multi-projector installations, you can adjust the brightness, colour and position of overlapping areas for seamless, beautiful displays.

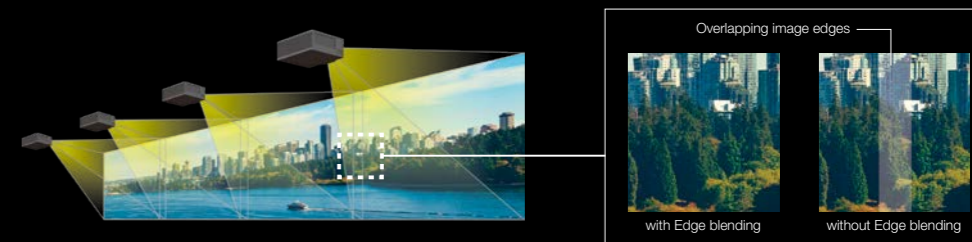

## Projection on Wide Curved and Corner Spaces

Fit your projection images nicely even on non-flat surfaces. Create stunning projection images on wide curved surfaces and corner walls, ideal for advertisements and marketing promotions.

# POWERFUL CONNECTIVITY



Equipped with a variety of connection possibilities, the versatile EB-L30000UNL can be programmed with a PC and via your smart devices. The projector supports a host of transmission outputs including 3G-SDI and HDBaseT, offering advanced edge blending to combine multiple edges for that smooth, unified look.

## Web Control with Smart Device Support

Use a computer web browser or smart device to adjust your projector settings. The newly designed OSD Control Pad function allows you to control the OSD menu and even view a representation of the lens-condition from your smart device.



## Blanking

With full adjustability on all edges, you can easily adjust the blanking width for oversized images or mask noise at the edges of the screen, even for images from a videocassette recorder.

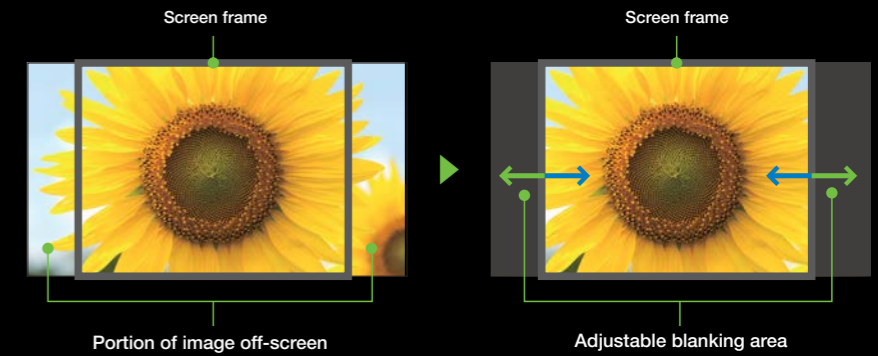

## Point Correction

Easily correct single-projector distortion or multi-projector misalignment directly on the screen. Quickly fine-tune the images by adjusting point by point from right to left, top to bottom, using a projected maximum 17 x 17 matrix.



## Black Level

Experience uniform black levels in overlapping areas of images even when using multiple projectors.



## Advanced Edge Blending

Precisely adjust edge blending to combine multiple edges for a seamless, unified look. This function allows you to fine-tune the start position and edge width of the blend as well as the area of the black level in the blend. It also prevents the main subject from being overlapped. As a tip, you can reduce the size of the overlapping areas to decrease the time it takes to combine multiple images.

## Extended Connectivity

Equipped with a diverse range of input terminals, the Epson LB-L30000UNL supports a host of transmission outputs including 3G-SDI and HDBaseT for long-distance transmissions.

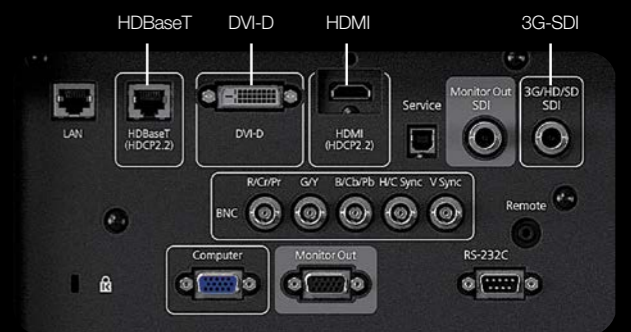



## Epson Projector Management Software

Maximise your time by staying in control remotely. You can check the status of all the projectors from one computer by connecting multiple Epson projectors to a network. The software also incorporates a message-broadcasting plug-in to send messages to Epson projectors over network. It is also able to power down all Epson projectors in the building after the working hours.

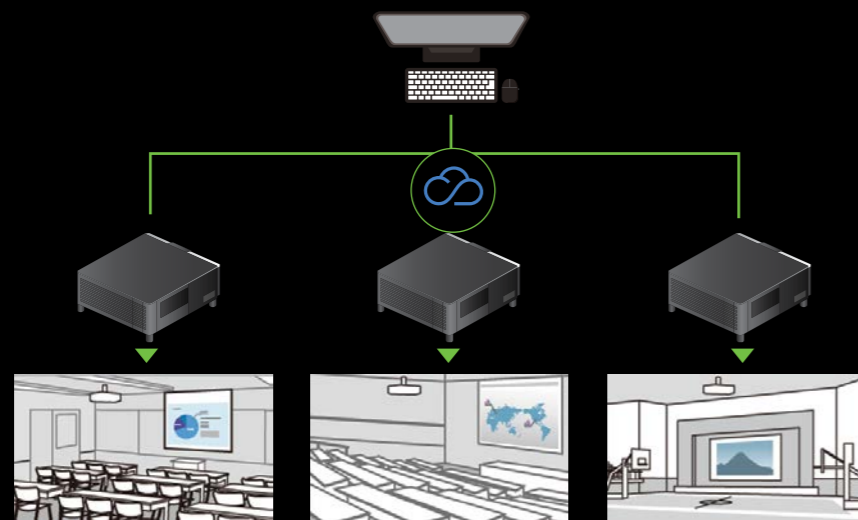

## Auto-scaling

Say goodbye to the complicated scaling of images from multiple projectors. With auto-scaling, simply select the screen layout from the pre-set menu and your projector will automatically set the slice area, scaling and edge-blend position for seamless projections.

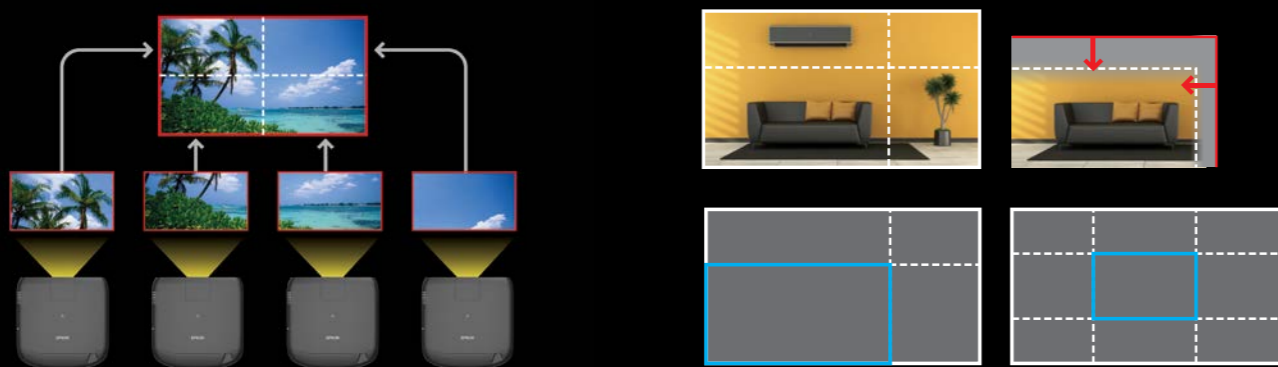

## DMX-ArtNet

The EB-L30000UNL supports DMX-ArtNet for synchronising lighting effects such as pre-programmed sequences with audio. Features you can control include power, shutter, switchgear, input source, lens drive (shift, focus and zoom) and lens memory settings.

## Eco Features

- Uses just 0.5W of power in standby mode
- Projector optics employ lead-free lenses
- Unpainted plastic housing reduces the environment impact
- The flame retardants used in the plastic housing do not contain chlorine or bromine

Better Products for a Better Future™

For more information on Epson's environmental programmes, visit <http://global.epson.com/SR/environment>.

**EPSON**  
EXCEED YOUR VISION

# PROJECTOR WISHES COME TRUE.

EPSON 3LCD PROJECTORS

1-CHIP PROJECTORS



Up to **3x**  
Brighter Colours  
with Epson Projectors\*

**TRUE BRIGHTNESS**

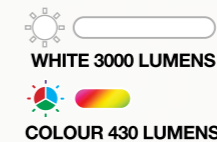
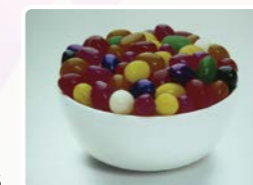
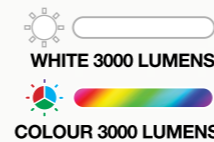

**NO RAINBOW EFFECT**

**TRUE COMFORT**



LIGHT SOURCE

PRISM

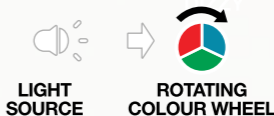

LIGHT SOURCE

ROTATING COLOUR WHEEL



UP TO **6x WIDER COLOUR GAMUT**  
Epson Projectors

**TRUE REALISM**

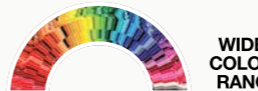

WIDER COLOUR RANGE

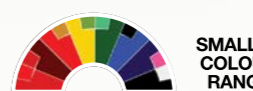

SMALLER COLOUR RANGE

**TRUE COLOURS**

Brighter, vivid projection from Epson.

9 out of 10 PEOPLE PREFER IMAGES FROM EPSON PROJECTORS



Find out more at [www.epson.com.sg/truecolours](http://www.epson.com.sg/truecolours)



**IT'S IN THE DETAILS.**

With 3LCD panels, every projection gives you spectacular true colours.

\* Leading Epson business and education projectors vs. leading 1-chip DLP® projectors, selected according to NPD data as of July 2015. Based on U.S. research conducted by Radius Research.

\*\* These lumen statistic can be found at [www.colorlightoutput.com](http://www.colorlightoutput.com).

1 Color brightness(color light output) in brightest mode, measured by a third-party lab in accordance with IDMS 15.4. Color brightness will vary depending on usage conditions. Top-selling Epson 3LCD projectors versus top-selling 1-chip DLP® projectors based on NPD sales data for May 2017 - April 2018.

2 Gamut volume in brightest mode, measured by a third-party lab in 3D in the CIE L\*a\*b\* coordinate space. Top-selling Epson 3LCD projectors versus top-selling 1-chip DLP® projectors based on NPD sales data for May 2017 - April 2018.

**SPECIFICATIONS**  
**EB-L30000UNL**

**EPSON**  
EXCEED YOUR VISION

**CAD DRAWING**  
**EB-L30000UNL**

**EPSON**  
EXCEED YOUR VISION

<b>MODEL NUMBER</b>	<b>EB-L30000UNL</b>	
<b>SKU Number</b>	V11H944852	
<b>Projection Technology</b>	RGB liquid crystal shutter projection system (3LCD)	
<b>Specifications of Main Parts</b>		
LCD	Size	1.43" (D8, C <sup>2</sup> Fine)
	Native Resolution	WUXGA (1920 x 1200)
	Refresh Rate	200 – 240Hz
Projection Lens	Type	Power Zoom / Power Focus / Power Shift / Power Distortion (Rear Projection: Wide Lens / Short Throw / Zoom Lens only)
	F-Number	1.9 – 2.1
	Focal Length	54.7 – 73.0 mm
	Zoom Ratio	1 – 1.35
	Throw Ratio (Base on ELPLM12)	1.74 – 2.35 (Wide - Tele)
	Lens Exchange	Yes
	Lens Shift Mode	Powered
	Vertical (Up/Down)	±65%
	Horizontal (Left/Right)	±30%
	Light Source	Type
	Life (Normal / Eco)	20,000 / 30,000 hours
<b>Screen Size (Projected Distance)</b>		
Zoom: Wide	100" - 1,000" [3.68 - 37.94 m]	
Zoom: Tele	100" - 1,000" [5.0 - 51.03 m]	
<b>Brightness<sup>1</sup></b>		
White Light Output (Normal / Eco)	30,000lm / 21,000lm	
Colour Light Output	30,000lm	
<b>Contrast Ratio</b>	Over 2,500,000 : 1	
<b>Geometric Correction</b>		
Vertical / Horizontal Keystone	±45° / ±30° (Zoom: Tele with Middle Throw Zoom Lens)	
Quick Corner	Yes	
Curve Surface	Yes (Except when in 4K Enhancement mode)	
Point Correction	Yes (Except when in 4K Enhancement mode)	
Corner Wall	Yes (Except when in 4K Enhancement mode)	
Geometry Correction Memory	Yes	
Split Screen	Yes	
<b>Connectivity</b>		
Analog Input	D-Sub 15Pin	1 (RGB, YCbCr, RGB-Video)
	5BNC	1 (RGB, YCbCr, RGB-Video)
Digital Input	HDMI	1 (HDCP 2.2)
	DVI-D	1 (Single Link, HDCP 1.4)
	HDBaseT	1 (HDCP 2.2)
	SDI	1 (SD / HD / 3G)
Analog Output	D-Sub 15Pin	1 (RGB)
Digital Output	SDI (BNC)	1 (SDI Loop-Through)
Control I/O	RS-232C	1
Remote		1 (Stereo Mini)
		1 (Optional Wireless LAN, Firmware Update, Copy OSD Settings)
USB I/O	Type A	1 (Firmware Update, Copy OSD Settings)
	Type B	1 (Firmware Update, Copy OSD Settings)
Network	Wired LAN	RJ-45 x 1 [Compliant with Control I/O (Art-Net)]
	Wireless	Optional (ELPAP10)
<b>Wireless Specification</b>		
Supported Speed For Each Mode	IEEE 802.11b: 11Mbps <sup>2</sup> IEEE 802.11g: 54Mbps <sup>2</sup> IEEE 802.11n: 130Mbps <sup>2</sup>	
Wireless LAN Security	Quick Mode: OPEN, WPA2-PSK Advanced Mode: OPEN, WPA/WPA2-PSK, WPA-Enterprise	
<b>Operating Temperature</b>		
	Low Altitude Mode: 0 - 50 °C <32 - 122 °F> (0m / 0ft - 2,286m / 7,500ft) High Altitude Mode: 0 - 45 °C <32 - 104 °F> (Over 2,286m / 4,921ft - 3,048m / 10,000ft) (20% - 80% Humidity, No Condensation)	
	0 - 3,048 m <0 - 10,000 ft> (Over 1,500m / 4,921ft : with High Altitude Mode)	
<b>Operating Altitude</b>		
<b>Direct Power On / Off</b>	Yes	
<b>Start-Up Period</b>	Less than 21 seconds, Warm-up period: 30 seconds	
<b>Cool Down Period</b>	Instant Off	
<b>Air Filter</b>	Type	High Efficiency Filter (with Smoke Filter function <sup>3</sup> )
	Maintenance Cycle	20,000 hours <sup>4</sup> (Normal) / 30,000 hours <sup>4</sup> (Extended)
<b>Power Supply Voltage</b>		
<b>Power Consumption (220 - 240V)</b>	Laser On (Normal / Eco) 2325W / 1511W Standby (Network On / Off) 2.5W / 0.5W	
<b>Dimension (D X W X H) (Incl. Feet &amp; Handle)</b>	860 x 936 x 378.5 mm	
<b>Weight (Incl. Handle, Exl. Lens)</b>	69.9kg	
<b>Fan Noise (Normal / Eco)</b>	49dB / 41dB	

**Supplied Accessories**

Power Cable  
Remote Control with 2xAA Batteries  
User's Manual CDFROM  
HDMI Cable Clamp

**Optional Accessories**

Air Filter: ELPAF52  
Wireless LAN Card: ELPAP10  
Remote Control Cable Set (10m x 2): ELPKC28  
HDBaseT Transmitter: ELPHD01  
Handle: ELPMB49 / ELPMB56 (with eyebolt)

**Optional Lenses**

Ultra Short Throw Lens: ELPLX03  
Rear Projection Wide Lens: ELPLR05  
Short Throw Zoom Lens1: ELPLU05  
Short Throw Zoom Lens2: ELPLW07  
Middle Throw Zoom Lens1: ELPLM12  
Middle Throw Zoom Lens2: ELPLM13  
Middle Throw Zoom Lens3: ELPLM14  
Long Throw Zoom Lens1: ELPLL09  
Long Throw Zoom Lens2: ELPLL10

EB-L30000UNL



©2020 Epson Singapore Pte Ltd. All Rights Reserved. Reproduction in part or in whole, without the written permission from Epson, is strictly prohibited.

EPSON and EXCEED YOUR VISION are registered trademarks of Seiko Epson Corporation.

All other product names and other company names used herein are for identification purposes only and are the trademarks or registered trademarks of their respective owners.

Epson disclaims any and all rights in those marks. Projected images shown herein are simulations. The actual product design and contents may vary. Specifications are subject to change without notice and may vary between countries. Please check with local Epson offices for more information.

Apple, iPad and iPhone are trademarks of Apple Inc., registered in the U.S. and other countries. App Store is a service mark of Apple Inc.

Android is a trademark of Google Inc.

Dealer's Stamp

Information correct at time of printing.  
Printed July 2020

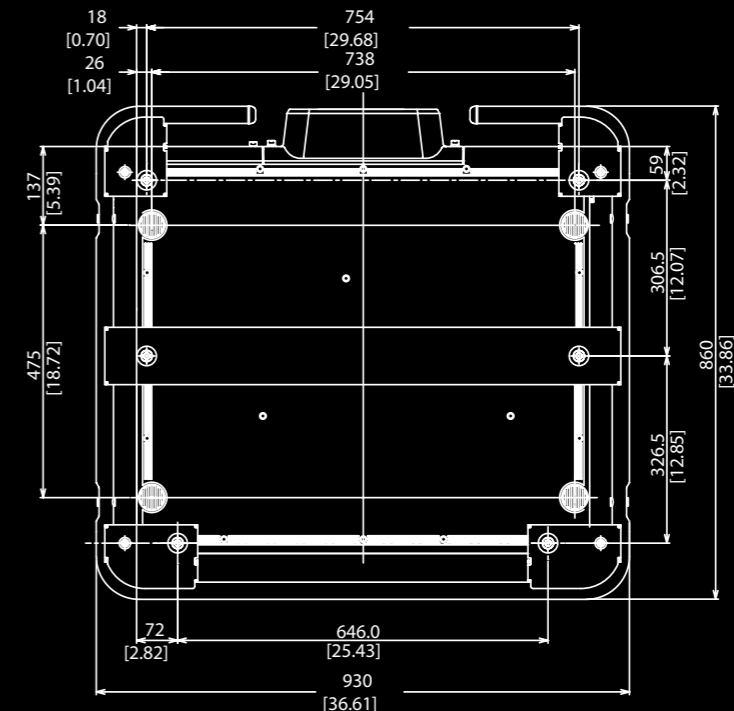
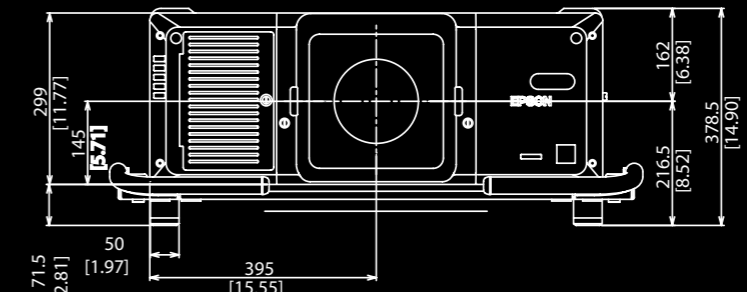
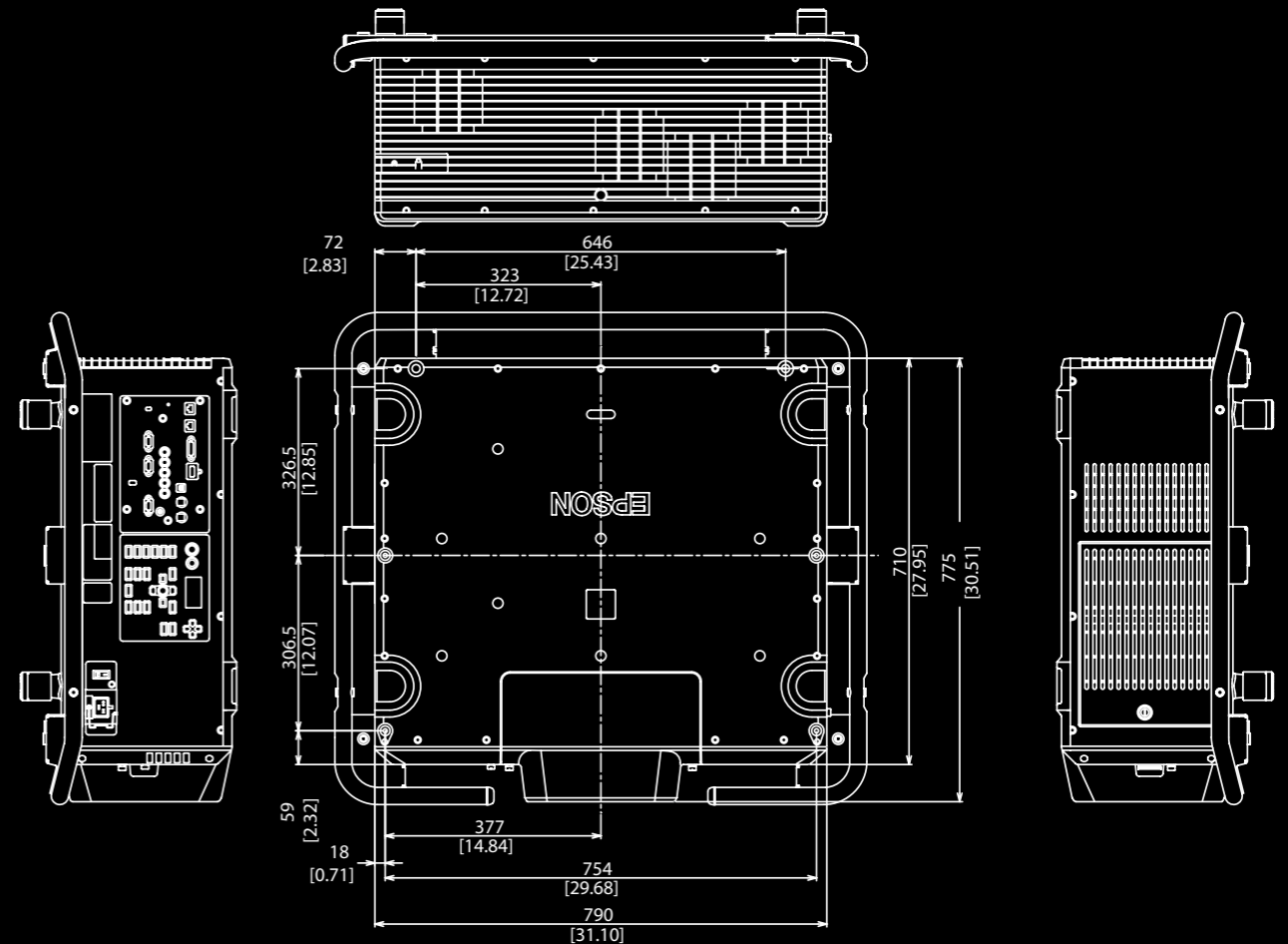

Sales Enquiries  
800 120 5564

[f](#) EpsonSEA [@](#) EpsonSEA [t](#) EpsonSEA [v](#) EpsonSoutheastAsia [in](#) Epson Southeast Asia

For latest specifications, visit [www.epson.com.sg/highbrightness](http://www.epson.com.sg/highbrightness) or call 800 120 5564.